

LA-UR-98-985

Approved for public release  
Distribution is unlimited

Title:

DISPOSITION OF NUCLEAR WASTE USING  
SUBCRITICAL ACCELERATOR-DRIVEN SYSTEMS:  
TECHNOLOGY CHOICES AND ONE IMPLEMENTATION  
SCENARIO

MARCH 6, 1998

Author(s):

Francesco Venneri - ATW  
Ning Li - MST-10  
Mark Williamson - NMT-6  
Michael Houts - TSA-10  
George Lawrence - APT

Submitted to:

NUCLEAR SCIENCE & TECHNOLOGY  
ICONE CONFERENCE - SAN DIEGO, CA

SCANNED APR 02 1999



LOS ALAMOS NATIONAL LABORATORY  
3 9338 00328 9971

**Los Alamos**  
NATIONAL LABORATORY

Los Alamos National Laboratory, an affirmative action/equal opportunity employer, is operated by the University of California for the U.S. Department of Energy under contract W-7405-ENG-38. By acceptance of this article, the publisher recognizes that the U.S. Government retains a nonexclusive, royalty-free license to publish or reproduce the published form of this contribution, or to allow others to do so, for U.S. Government purposes. Los Alamos National Laboratory requests that the publisher identify this article as work performed under the auspices of the U.S. Department of Energy. The Los Alamos National Laboratory strongly supports academic freedom and a researcher's right to publish, but as an institution, however, the Laboratory does not endorse the viewpoint of a publication or guarantee its technical correctness.

## **DISPOSITION OF NUCLEAR WASTE USING SUBCRITICAL ACCELERATOR-DRIVEN SYSTEMS: TECHNOLOGY CHOICES AND IMPLEMENTATION SCENARIO - ICONE-6526**

Francesco Venneri, Ning Li, Mark Williamson, Michael Houts, George Lawrence  
Los Alamos National Laboratory

### **ABSTRACT**

*Los Alamos has led the development of Accelerator-driven Transmutation of Waste (ATW), to provide a fundamental technological solution to the nuclear waste problem. While ATW will not eliminate the need for a high-level waste repository, it offers a new technology option for altering the nature of nuclear waste and enhancing the capability of a repository. The basic concept of ATW focuses on reducing the time horizon for the radiological risk from hundreds of thousands of years to a few hundred years and on reducing the thermal loading. Furthermore, ATW will greatly reduce the amount of waste that has to be disposed of in a high-level waste repository. The goal of the ATW nuclear subsystem is to produce a three orders of magnitude reduction in the long-term radiotoxicity of the waste sent to a repository, including losses through processing. If the goal is met, the radiotoxicity of ATW-treated waste after 300 years would be less than that of untreated waste after 100,000 years.*

*These objectives can be achieved through the use of high neutron fluxes produced in accelerator-driven subcritical systems. While critical fission reactors can produce high neutron fluxes to destroy actinides and the selected fission products, the effectiveness of the destruction is severely limited by the criticality requirement. Furthermore, to achieve safe reactor operations, a substantial amount of excess reactivity would have to be supplied initially and compensated for by control poisons. To overcome these intrinsic limitations, we searched for solutions in subcritical systems freed from criticality requirement by taking advantage of the recent breakthroughs in accelerator technology and the release of liquid lead/bismuth nuclear coolant technology from Russia. The effort led to the selection of an accelerator-driven subcritical system that results in near complete destruction of the actinides and fission products of concern, as well as permitting easy operational control through the external control of the neutron source rather than the internal control rods*

### **1. INTRODUCTION**

Spent reactor fuel from commercial power plants contains significant quantities of plutonium, other fissionable actinides and fission products, all of which create challenges for permanent disposal because of the very long half-lives of some isotopes and because of the potential for diversion. If the level of global nuclear power generation for the near future continues as it exists today, then in the year 2015 more than 250,000 tons of spent fuel worldwide will have to be stored, containing over 2000 tons of plutonium. Well over 70,000 tons of this spent fuel will be in the US, containing more than 500 tons of plutonium (600 tons of transuranic actinides).

While there is agreement on using geologic repositories for the ultimate disposal of high-level nuclear waste, different strategies for dealing with spent nuclear fuel are being followed by various countries, reflecting their views on nuclear power, reprocessing and non-proliferation. Current US policy is to store unprocessed spent fuel in a geologic repository. Other countries are opting for treatment of spent fuel, including partial utilization of the fissile materials contained in the spent fuel prior to geologic storage.

LOS ALAMOS NATL LAB LIBS  
3 9338 00328 9971

Key issues for the current US repository concept fall into two categories, (1) a long-term radiological risk with the peak risk projected tens of thousands of years after repository closing and (2) a short-term thermal loading (decay heat) that limits the capacity of the repository. While not identified as an issue, it is clear that the repository, designed for 70,000 tons of commercial spent fuel and other government-generated high-level waste (mostly from defense-related activities), will be fully occupied by the spent fuel produced through the year 2015. If the nuclear energy remains to be a viable option for electricity generation in the future, ultimately there will be a need for a second high-level waste repository.

Studies have shown [1,2] that the repository long-term radiological risk is from the long-lived transuranics and the fission products Tc-99 and I-129, thermal loading concerns arise mainly from the short-lived fission products Sr-90 and Cs-137.

In relation to the disposition of nuclear waste, ATW is expected to accomplish the following:

- (1) Destroy over 99.9% of the actinides. Actinide destruction eliminates concerns with their releases to the ground water and the environment, their possible diversion and use in the spent fuel for weapons construction. Their elimination will also greatly reduce long-term heat loading.
- (2) Destroy over 99.9% of the Tc and I. By transmuting technetium and iodine, two of the major long-term radiotoxicity release hazards can be eliminated.
- (3) Separate Sr and Cs (short half-life isotopes). Sr-99 and Cs-137 dominate the repository short-term heat loading. These isotopes are not suited for transmutation but will be separated from the remainder of the waste for optimal storage.
- (4) Separate uranium. Uranium is separated from the rest of the spent fuel, stored or re-enriched for further use.
- (5) Produce electricity. The ATW resembles in many ways a nuclear reactor in that it releases energy during actinide destruction (fission) that can be converted into electricity. A small fraction (10-15%) of this electricity will be used to power the accelerator, the rest can be distributed for sale.

In the ATW concept, spent fuel would be shipped to a ATW site where the plutonium, other transuranics and selected long-lived fission products would be destroyed by fission or transmutation in their only pass through the facility. This approach contrasts with the present-day reprocessing practices in Europe and Japan, during which high purity plutonium is produced and used in the fabrication of fresh mixed-oxide fuel (MOX) that is shipped off-site for use in light water reactors. Instead of "reprocessing", the ATW approach can be fairly characterized as "once-through destruction". ATW would inhibit plutonium accumulation, proliferation and diversion. The end products of ATW are a more benign fission product waste stream, uranium similar in composition to natural uranium, and electricity. The electricity produced, and the potential cost benefits realized by enhancing the capacity of a repository (and elimination of the need for an additional repository), could offset to some extent the cost of developing and implementing the ATW technology.

Far from being limited to waste destruction, ATW technology also brings to the table new concepts that could be relevant for the next-generation power producing systems. As such, ATW has gained worldwide interest and could be an important component of strategies to deal with international nuclear materials management and promote new, proliferation-resistant, safe reactor technologies.

## **2. ATW SYSTEM DESCRIPTION**

An ATW facility consists of three major elements: (1) a high-power proton linear accelerator; (2) a pyrochemical spent fuel treatment / waste cleanup system; (3) a liquid lead-bismuth cooled burner that produces and utilizes an intense source-driven neutron flux for transmutation in a heterogeneous (solid fuel) core (Fig. 1). The concept is the result of many years of development at LANL [3] as well as other major international research centers [4].

The high-power accelerator for ATW would be based on the APT (Accelerator Production of Tritium) accelerator (1.7Gev, 100mA, 170MW proton beam). An accelerator, similar to but smaller than the one now being designed for tritium production would serve as the driver (40 MW) to a subcritical burner, where transuranics and selected fission products are fissioned or transmuted.

In the spent fuel treatment system (Fig. 2), uranium and a majority of the fission products are separated from the transuranics and the targeted long-lived fission products by pyrochemical (non-aqueous) processes. The only requirement is the separation of enough uranium (99%) so that no significant new plutonium or other actinides are produced during transmutation. Fission product extraction is not explicitly sought but comes out naturally from the process.

The flow of the spent fuel in the treatment system can be broken down into three basic streams. One stream contains the spent fuel cladding metal, the majority of the fission products from the spent fuel, and the remaining fission products from the transmuted waste, all of which is prepared for permanent disposal. Following the electrochemical extraction of the uranium, a second stream consists of actinides and some cladding zirconium, which is cast into solid metallic fuel elements ("transmutation assemblies") to be introduced into the subcritical burner for irradiation. The third stream consists of the uranium sent out and stored for possible recycle.

In one reference design concept, a third of the core is extracted and processed every year. In the ATW waste cleanup process, eventually all the fission products in the irradiated waste are partitioned into three forms: active metals, noble metals and lanthanides. This remnant waste is prepared for permanent storage as: (1) oxides in engineered containers for the active metals (including strontium and cesium), (2) oxides for the lanthanides, and (3) metal ingots and oxides for the noble metals including zirconium. An average of 50 kilograms of fission products, per ton of spent fuel, are discharged as waste after transmutation (including the fission products originally present in the spent fuel), contaminated with less than 100 ppm of transuranics (mostly in the metal oxide waste form). Most of the radioactivity in the discharges would decay before three hundred years, with only weak residual activity of negligible environmental impact remaining afterwards.

The waste burner consists of a heavy metal target (liquid lead-bismuth eutectic (LBE)) producing the high intensity neutron source and the surrounding subcritical core containing the transmutation assemblies (Fig. 3). Since significant neutron multiplication and heat production occurs from the fissioning of the waste actinides contained in the surrounding transmutation assemblies, adequate means for heat removal must be present, analogous to critical reactors of similar power level. ATW takes advantage of the exceptional properties of liquid LBE, both as nuclear coolant and as spallation neutron source, for use in the subcritical waste burner. The technology, successfully developed and used in Russia for nuclear submarine propulsion of very fast, deep diving vessels, is becoming accessible to western researchers and engineers.

The subcritical liquid LBE systems presently being developed at Los Alamos operate in the fast neutron spectrum, to ensure optimal destruction efficiency for the actinides and large neutron availability for transmutation of the targeted fission products. Very low end-of-life inventories are rapidly achieved by burn-down strategies involving gradual thermalization of the spectrum to exploit the large capture cross sections of resonances.

Subcriticality does not make ATW by definition "safer" than critical reactors. Rather, subcriticality facilitates tasks that would be exceedingly difficult or inefficient in critical systems. Subcritical systems do not rely on delayed neutrons for control and power change, they are driven only by the externally generated neutron source (*i.e.* by the ion beam coming from the accelerator). Control rods and reactivity



# Desired Outcome of Program

---

---

**ATW has reached a stage where further investigation would determine its suitability and the role it may have in a future nuclear economy.**

**To date, studies within the US have been limited to Institution-supported investigations at rather low levels.**

**Engineering development and demonstration activities in the 5-year program would provide useful information for bringing the technology and options to a point for informed decisions.**

# Where are we since STATS Panel?

---

In 1991 (report 1996) the National Research Council (STATS panel) concluded that Separations and Transmutation (including ATW) was:

- » immature
- » too expensive
- » leading to proliferation
- » commits to expanding nuclear energy
- » doesn't significantly impact need for repository

Technology advancements answer most of the concerns expressed seven years ago.

# Concerns

---

---

## **Political related issues:**

- **Reprocessing**
- **Fuel cycles**
- **Licensing**
- **Waste management**

**Are we making the best investments to ensure a sustainable and favorable energy future for future generations?**

**Are decision makers being given the best data to make decisions that will have future impacts?**

# What about International Interests?

---

**Common technical approach has evolved -- liquid Pb/Bi coolant, solid fuel, pyrochemistry, sub-critical accelerator drive.**

**Europe (Spain, Italy, France, Sweden, Czech Rep.)**

**Asia (S. Korea, Japan)**

**ISTC funding assists Russia and other FSU countries.**

**Collaborations -- CERN, KAERI, JAERI, CEA, Sweden.**

# US Participation -- Other

---

---

## Laboratories

- » **Argonne:** Have assisted us in pyrochemistry. Preliminary discussions with them on possible interests in ATW.
- » **Oak Ridge:** Have assisted us in liquid metals and materials. Preliminary discussions with them on possible interests in ATW.

## Universities

- » **Host of Ph. D. and M. Sc. thesis topics** would be spun out of this program.

**We would like to see them as part of the team.**

# **US Participation -- Present**

---

---

## **Laboratories**

- » **Los Alamos: Systems, Pb/Bi, Chemistry, Accelerator, Materials.**
- » **Livermore: Systems studies, Pb/Bi, Safety.**
- » **Sandia: Safety, Systems analysis, Materials, Diagnostics.**
- » **Savannah River: Engineering and Operations.**

## **Industry**

- » **Westinghouse: Nuclear design, Liquid Pb/Bi Technology.**
- » **Bechtel: Engineering.**
- » **Northrup-Grumman: Accelerators, Systems.**

## **Universities**

- » **Illinois: Materials development.**
- » **UC Berkeley: Nuclear design.**

**~~LANSCE~~**

# **Spin-offs from 5-Year Program**

## **Important Outcome/Legacy**

---

---

**Liquid lead/bismuth technology for future advanced nuclear systems.**

**High power spallation targets for basic science research.**

**Waste disposition processes for environmental management.**

**System studies that will provide advanced fuel cycle information and a basis for future decisions/directions.**

# Plans and Program

---

---

**With industry we have developed a viable program plan for ATW and determined rough cost estimates; results indicate the need for further comprehensive study.**

**We have a strong team pulled together, with the intention of making it even stronger with future additions.**

**The five year program discussed later focuses on leveraging items and important issues-- mass flows, pyrochemistry, materials verification, technology transfer and integration, liquid Pb/Bi cooled cores with integral target, accelerator, system studies.**

**LANSCE**



# ATW System

---

---

If the scenario were to transmute all of the 70,000 tons of reactor spent fuel accumulated to 2015 within a 65 year time-frame, then:

**Input:** =70,000 tons (including 600 tons TRU).

**Output:** \*67,000 tons uranium (LLW).

\*<0.3 tons TRU.

\*3000 tons fission products (minimal Tc and I).

\*electricity.

\*residual activity and radiotoxicity of waste after 300 years less than non-assisted repository after 100,000 years.

**LANSC**

# **ATW Based on Three Major Functional Blocks**

---

---

**Subcritical burner using liquid lead/bismuth technology based on extensive Russian nuclear reactor work and on solid fuel.**

**Pyrochemical processes based on significant work at ANL and LANL on efficient processes that have potential for proliferation resistance and low environmental impact.**

**APT-class accelerator (although about 40 MW of beam power required -- re 170 MW for APT: building blocks are based on SDIO investments and APT developments in high power linac technology).**

# Present System is a Design Evolution

---

---

Many options for ATW have been studied at LANL, as well as comparisons of critical nuclear assemblies with accelerator-driven systems. Design has matured significantly, being based on elements that have evolved within the international community as well:

- » subcritical assembly, fast n spectrum, accelerator drive, liquid Pb/Bi coolant, solid fuel and pyrochemistry.

Present design *IS NOT* based on previously considered elements such as:

- » molten salt, thermal n spectrum, liquid fuels, centrifuge separations.

# Assisting the Disposal Option

---

---

**ATW can assist a repository in many ways.**

**Whether waste disposal is based on fully buried or on monitored and retrievable, the material can be treated by an ATW system in the future. ATW ultimately impacts capacity efficiency of a repository.**

**ATW thereby impacts the need for a second repository:**

- » **increasing storage efficiency by transmutation.**
- » **increasing storage efficiency by types of materials.**
- » **decreasing long-term risks.**

**In addition:**

**converting transuranics to useful energy.**

# **ATW: What is it?**

---

---

**Assisting waste disposal options by transmuting waste.**

**Accelerator provides protons that produce copious neutrons from spallation target. These neutrons assist the nuclear system to transmute transuranics by fission, and fission products (Tc and I) by absorption.**

**Subcriticality (accelerator drive) enables the destruction of actinides and fission products: safely, without isolation of weapons grade material, without extensive separations work : in a single-purpose device.**

# Past and Future Interests

---

---

**Because of an interest in future energy economies for the country, LANL has made a significant investment in studies for ATW over the past eight years.**

**We have reached a stage where it would be prudent to take the next step in technology development -- the 5-year plan.**

**This path of ATW technology development could be a bridge to future nuclear options/strategies (PCAST), even if ATW was not added to the suite of systems.**

# Premise

---

---

**Economics appear favorable for ATW-assisted waste management system.**

**Technical path identified; with no show stoppers.**

**Proposed 5-year engineering design and development program addressing key issues provides direction and provides logical exit criteria.**

**Positive environmental/societal impact.**

# Outline

---

---

**Past and present.**

**Assist waste disposal options.**

**System description.**

**Participation.**

**Outcomes.**

**Agenda.**

**Charge.**

***Details provided in following presentations.***

**~~LANSGE~~**



# **The Problem -- Nuclear Waste Issue**

---

---

**Issue is nuclear waste disposal -- ATW is a  
technology option.**

**ATW can assist waste disposal options -- whether fully  
buried, monitored and retrievable, or interim storage.**

**Permanent repository still necessary (but more efficient  
use of capacity with ATW).**

---

---

# **Welcome and Introduction**

## **MIT ATW Technical Review 1998, Jan. 15-16**

**Stan O. Schriber  
Deputy Division Director  
LANSCE Division**

**~~LANSCE~~**

# Agenda

Los Alamos National Laboratory

**MIT ATW Technical Review  
MIT Nuclear Engineering Department  
Plasma Physics & Fusion Center, NW17  
Second Floor Conference Room**

**Chair - Professor M. Kazimi**

**January 15, 1998  
Thursday**

08:30 - 08:45	Informal Gathering	
08:45 - 09:30	Welcome and Introduction	S. Schriber, LANL
09:30 - 11:30	ATW Overview	F. Venneri, LANL
11:30 - 11:45	Break	
11:45 - 13:15	ATW Demonstration Conceptual Characterization	M. Carelli, Westinghouse STC
13:15 - 14:00	Lunch (Box lunches provided)	
14:00 - 15:00	ATW Nuclear Performance	M. Hours, LANL
15:00 - 15:15	Break	
15:15 - 17:15	ATW Process Chemistry	M. Williamson, LANL A. Schake, LANL

**January 16, 1998  
Friday**

08:30 - 09:30	Accelerator Design for ATW	G. Lawrence, LANL
09:30 - 12:15	Liquid Lead Technology and Engineering	Y. Orlov, A. Dedoul, IPPE
11:00 - 11:15	Break	
	Continue Liquid Lead Technology	N. Li, LANL K. Woloshun, LANL
12:15 - 13:15	Program Plan and Summary	F. Venneri, LANL
13:15 - 14:00	Lunch (Box lunches provided)	<i>Executive Session</i>
14:00 - 15:00	Collaborator's Comments - Further Details as Requested	
15:00 - 17:00	Executive Session	
17:00 - 18:00	Verbal Feedback	

## *ATW Backlog Burndown scenario*

*Number of ATW units, coming on line, closing down*

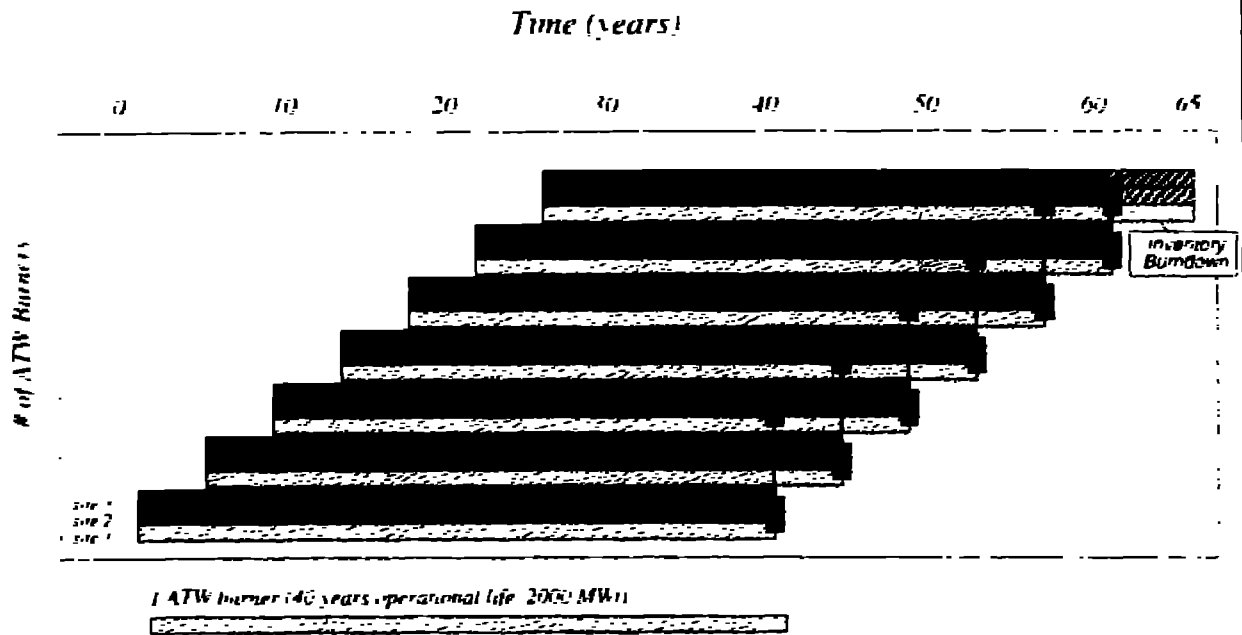

*Figure 5*

***ATW Backlog Burndown scenario:  
Large Reduction in Transuranic Inventory  
achieved in time comparable to plant's lifetime***

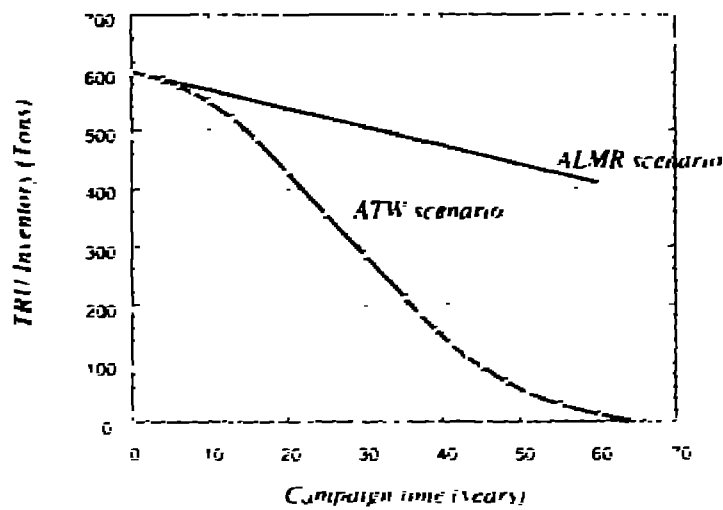

*Figure 6*

## Accelerator Drive (Subcriticality) enables versatile and effective Nuclear Waste Destruction

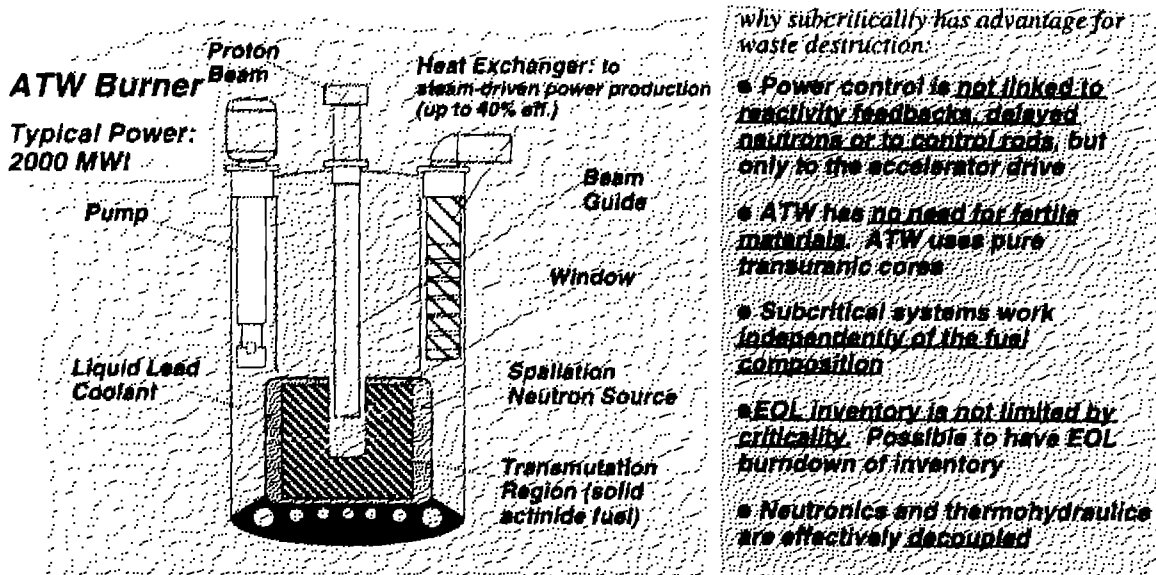

Figure 3

Core Map for 2000 MWt ATW Burner

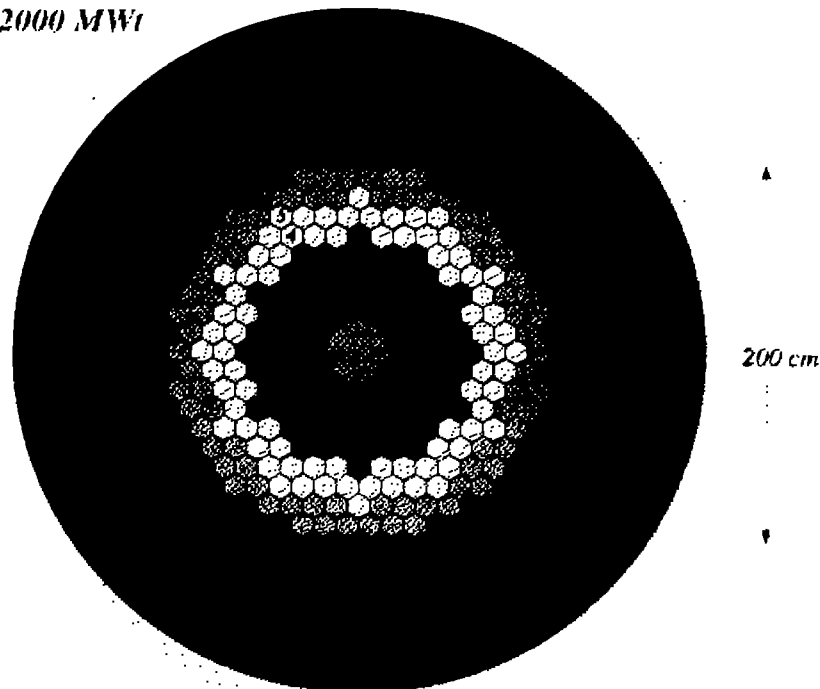

Figure 4

# ATW Consists of Three Major Functional Blocks

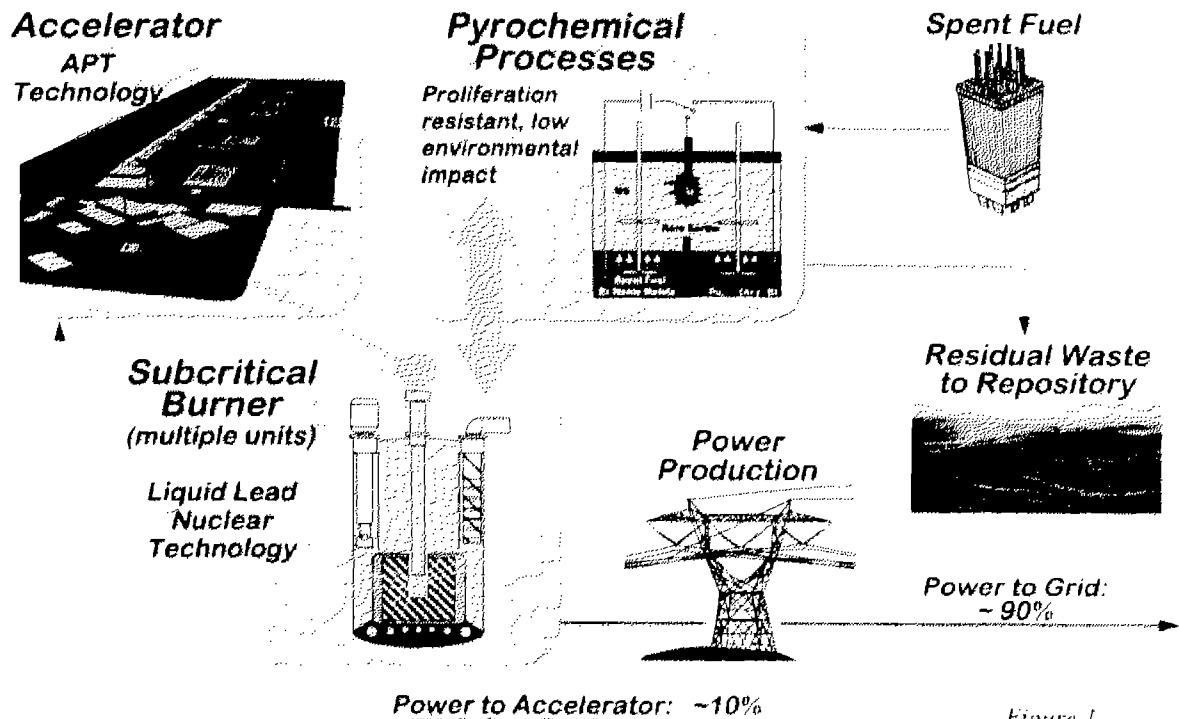

Figure 1

## ATW Waste Treatment is based on Pyrochemical Processes developed at Los Alamos and Argonne

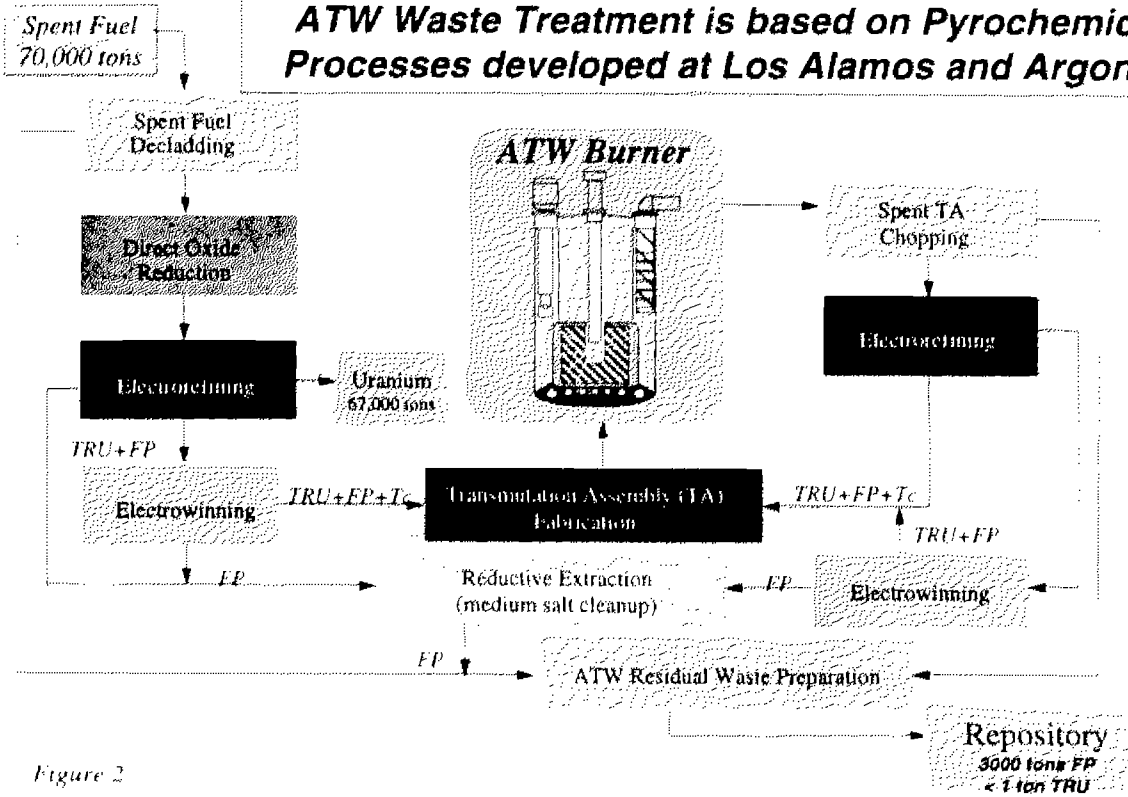

Figure 2

feedback have very low importance: these systems are neutronic (but not thermally) decoupled from their neutron source. Subcriticality therefore allows the ATW system to work with any composition of fuel (or waste) and to greatly relax the required separation in the waste treatment steps. This makes possible, in principle, the destruction of any isotopes (actinides or fission products or mixture of both) with little concern for their neutronic behavior. Fertile materials are not needed to compensate for the neutronic uncertainties or undesirable reactivity responses of the fuel, and extended burnup is achieved by increasing the power of the accelerator drive to compensate the reactivity decrease.

Because of its subcritical mode of operation, ATW will be ideally suited as "incinerator" of material that: (1) is not well characterized; (2) burns very poorly or not at all in reactors; (3) has potentially unstable and hazardous reactivity responses; and (4) should not for whatever reason be isolated and placed in reactors. This includes higher actinides such as neptunium (the worst contributor to an oxidizing repository long-term performance uncertainties), americium and curium, all isotopes of plutonium and some long-lived fission products. In addition, the neutron-poor thorium-uranium fuel cycle, never successfully implemented in critical reactors, can be used rather straightforwardly in accelerator-driven subcritical systems.

### **3. LINAC**

The 1000 MeV reference linac design for ATW is based on consideration of a number of important issues. These include low beam losses, high efficiency of electrical power to beam power conversion, reliable operations, insensitivity to errors in alignment and settings, and cost optimization. The design uses demonstrated components to transmit the beam through the different energy regimes. Initially the beam is accelerated to 6.7 MeV in a RFQ (Radio Frequency Quadrupole) based on a well-defined beam emerging from a reliable injector. A suitable injector has been working for months at LANL with currents in excess of a factor of two for what ATW needs and with beam parameters better than the ATW requirements to ensure low beam loss. In addition, the CRITS RFQ has been accelerating a proton beam with good transmission and beam parameters exceeding the ATW requirements.

Following the RFQ is a CCDTL (Coupled Cavity Drift Tube Linac) that will be demonstrated in the APT LEDA program. This structure has revolutionized the ability to transport high quality beams from a RFQ to following structures. The 21.2 MeV beam from the CCDTL is then fed into a set of superconducting cavities that take the beam up to 1000 MeV. The first type of cavity that accelerates the beam to 100 MeV is based on a "spoke" resonator design that will require some testing before it is fully qualified for this program. All indications are that there should be no problems with this geometry because there should be no problems with the required field levels in the cavities and previous tests with these lower beta structures showed their benefits.

The last stage of acceleration will be with elliptical shaped cavities: these have been demonstrated to be able to meet the required performance regimes necessary for ATW. The ATW linac length is 355m with an rf power need of 42.3 MW for a 40 MW beam. The accelerator was designed for 40 MW in order to be able to drive up to a total 2000 MWt fission power, which could be distributed within one or more modules. The first Demo ATW is projected to be a 500-1000 MWt system.

### **4. FUEL CYCLE TECHNOLOGY**

Spent fuel treatment technology is derived from pyrochemical processes developed for plutonium production at Los Alamos [5] and the Integral Fast Reactor program at Argonne [6]. Pyrochemical processes were chosen over the conventional aqueous processes because they are proliferation resistant - group separations are used instead of single species separations; allow the processing media, molten salts and liquid metals, to be recycled multiple times thus reducing secondary waste; and allow for short

turnaround times for waste treatment - radiolysis and decay heat are not significant issues [7]. In addition, the product from the electrochemical processes is easily fabricated into fuel for the system. The central development issue for process chemistry is to establish process scaling information by designing, fabricating, and testing various separation systems and then using that information to develop a more detailed material balance for the fuel treatment processes and process plant parameters. An ATW fuel treatment facility would be similar to the fuel cycle facility proposed for the Advanced Liquid Metal Reactor (ALMR) Program [8]. The following sections provide a brief overview of process chemistry and fuel technology for the ATW system.

#### 4.1 Process Chemistry

The flow sheet, shown in Figure 2, gives an overview of the flow of material from a spent fuel storage facility to the repository. Process technologies are based on modifications of existing technologies so as to achieve the ATW process requirements (see section 1). A brief description of the flow sheet using as an example the conversion of spent uranium oxide fuel to ATW fuel and the recycle of ATW fuel follows.

Spent fuel chopping and decladding found at the front end of the flow sheet is a mechanical process that chops the fuel rods into small sections and allows for the separation of the spent fuel, uranium oxide, from the clad matrix, zircalloy. This process is based on technology used at the major reprocessing plants in Europe. Separation of the oxide fuel from clad material is desired so that the clad material is not carried into the chemical processes. The clad material could be used as the inert matrix in ATW fuel. Fission product gases, primarily xenon and krypton, released during the decladding process are collected by cryogenic methods, or in getter-beds, and sent to storage. The gas collection system is based on technologies used in Europe and those studied and proposed for use in the US.

Spent oxide fuel is converted to metal by the direct oxide reduction process. This process involves the reaction of calcium metal with the oxide fuel to produce calcium oxide and heavy metal (i.e., U, Np, Pu, Am, Cm). It is completed in a calcium chloride molten salt flux maintained at approximately 1025 K. Some fission product partitioning takes place during the oxide reduction process. Fission gases are released from the matrix of the oxide fuel and are recovered by the same methods described for the decladding system. Active metals, such as cesium, strontium, and barium, are partitioned to the molten salt and are periodically removed from the salt during the direct oxide reduction salt recycle process, placed in engineered storage containers, and sent to the repository. Iodine is also partitioned to the molten salt and recovered from the salt during the salt recycle process. It is collected by cryodistillation methods, fabricated into targets, and transmuted in the ATW system. The heavy metal produced in the oxide reduction process is sent to the electrorefining system.

Electrorefining is used to partition the uranium, transuranics (TRU), and fission products. The system uses electrochemical methods to electrotransport the U from the anode to a solid cathode. The U-bearing cathode is removed from the system and either sent to storage or recycled. An eutectic mixture of NaCl-KCl molten salt, at approximately 1000 K, is used as the transport medium. Noble metal fission products (i.e., Zr, Mo, Ru, etc.) remain at the anode heel in the cell. The anode heel is subjected to a second electrorefining process to further reduce the amount of TRU present in the matrix. It is then sent to the technetium recovery process before being discharged to the repository. TRU's and rare earth fission products remain in the molten salt. This salt is treated by the electrowinning process.

Electrowinning is an electrochemical process used to electrodeposit the TRU's from the NaCl-KCl molten salt. The TRU's, present in the molten salt as complex chlorides, are reduced at the cathode of the cell. A sacrificial anode is used to react with the free chloride produced by the reduction of the TRU's. The TRU's are transferred to the vacuum casting fuel fabrication system. Fuel for the system is 85% Zr, or



zircalloy, - 15% TRU clad in steel. The molten salt is recycled to the electrorefining system after the rare earth fission products are removed from the salt by a reductive extraction process. After the extraction process, the rare earths are collected, oxidized, packaged, and sent to the repository.

Technetium is removed from the electrorefining anode heels and sent to the ATW system for transmutation. Tc is separated from the anode heels by oxidation of the anode metals followed by the distillation and condensation of  $Tc_2O_7$ .  $Tc_2O_7$  is converted to Tc by a direct oxide reduction process. The Tc metal is alloyed with Mo or Ru, fabricated into targets, and irradiated in ATW. The remaining transition metal oxides are packaged and sent to the repository.

The back-end of the fuel cycle uses processes similar to those used at the front-end. Spent ATW fuel is chopped and decladded by standard techniques. It is transferred to an electrorefining system where the TRU's are partitioned from the active metal, noble metal, and rare earth fission products. These TRU's are sent to the vacuum casting system where fresh ATW fuel is fabricated. Fission product gases released during the electrorefining processes are collected by the aforementioned methods. Noble metals are removed from the electrorefining cell, transferred to the Tc recovery process, and ultimately sent to the repository. Periodically the TRU content in the transport molten salt is decreased by using the aforementioned electrowinning process. Also periodically, the rare earth fission products are removed from the electrorefining salt by reductive extraction techniques and are collected, oxidized, packaged, and sent to the repository.

Although electrorefining is used in both the front-end U removal and back-end TRU recycle process, differences exist between the two systems. The front-end system is larger than the back-end system, about 400 kg of U is electrotransported in the process as compared to about 8-10 kg of TRU in back-end process. The process parameters, cell operating current and process time, are quite different. Moreover, the back-end system must be designed to process Pu-rich mixtures of TRU instead of low enriched U. Scaling of the electrowinning systems follow that of the electrorefining system.

#### **4.2 Metallic Fuel**

Existing technology is used wherever possible in the ATW nuclear subsystem. The primary exception is the ATW fuel. The need to eliminate uranium from the waste, the desire to use LWR clad (zircalloy) as the inert fuel matrix, and the desire to make processing as simple and waste-free as possible drives the fuel form to a zirconium-based metal matrix with an initial transuranics loading of about 15%. The fuel is a high melting alloy ( $> 1900$  K) and at the operating temperature of the transmutation system is a solid solution of TRU in alpha zirconium. Metallic fuels have long been proposed for use in ALMR's and have been studied in experimental reactor facilities. Much like other development metallic fuels, ATW fuel will require both irradiation and materials compatibility testing. Specific issues include fuel swelling, burn-up limits, fission product, especially fission gas, in-growth, fuel / clad interactions, and fuel / clad bonding materials.

### **5. LEAD-BISMUTH EUTECTIC NUCLEAR COOLANT AND SPALLATION TARGET**

Lead-Bismuth eutectic (LBE) possesses some unique physico-chemical properties, making it an excellent nuclear coolant and spallation neutron source. LBE's (44.5wt% Pb - 55.5wt% Bi) low melting point ( $123.5^{\circ}C$ ), high boiling point ( $1670^{\circ}C$ ) and very low vapor pressure allow for a wide operating temperature range, eliminates coolant boiling and enhances circuit safety. The high density of LBE combined with wide permissible temperature range offers extraordinary natural convection cooling capability for enhanced passive safety. LBE's low chemical activity inhibits violent reactions (fire and explosion) with air and water. The sealed vessels and circuits readily prevent air-borne lead contamination from exceeding established industrial standards ( $0.01$  mg/m<sup>3</sup> in Russia,  $0.03$  mg/m<sup>3</sup> in US).

The choice of LBE coolant for the ATW system is based primarily on two factors. First, the LBE can be used as both the coolant and the spallation target. Second, the use of LBE results in a negative overall coolant void and temperature reactivity coefficient [9].

The integration of nuclear coolant and spallation target in the current ATW concept drastically improved the subcritical burner design by simplifying flow configuration, material compatibility and removing target structures in high proton and neutron fluxes. LBE has very high useful neutron production during spallation and extremely low neutron capture cross sections. This neutron transparency allows for a widely spaced core with much reduced pressure drop and pumping power requirement. The coolant is also self-shielding against gamma radiation.

A schematic of the ATW nuclear subsystem is shown in Figure 3. The choice of the pool configuration is consistent with the objectives to use proven solutions (the pool configuration was chosen over the loop option for LMRs worldwide) and to maximize safety. The actinide-containing region is 2 m high by 2 m in diameter. An 0.6 m diameter central region contains LBE that is used as the spallation target. The top of the target is located 0.15 m above the mid-plane of the actinide-containing region, and a window separates the inside of the beam tube from the LBE. Passive systems are used to ensure that if LBE temperature exceeds that expected during normal operation the beam tube will be flooded with LBE, effectively removing the neutron source from the actinide-containing region and shutting down the transmutation process.

An intermediate loop could be avoided to reduce cost and in fact some Russian designs place a steam generator directly inside the primary pool. However, it was decided to adopt an intermediate heat exchanger in the ATW concept to contain polonium (produced by neutron capture in bismuth), spallation products and other radioactive isotopes. The secondary coolant is non-radioactive LBE. A minimum 1 m thick LBE reflector surrounds the waste assemblies on all sides. This reflector helps minimize required actinide loading, flattens the power density across the fissioning region, shields the vessel walls from fast neutrons, and provides thermal inertia. A core map is provided in Figure 4.

### **5.1 Existing Russian LBE Nuclear Coolant Technology**

Although LBE can be rather corrosive and can be contaminated by solid admixtures due to interaction with construction materials and oxygen, the Russians developed the "heavy metal technology" to mitigate these adverse effects by selecting proper materials and actively controlling oxygen thermodynamic activity in the coolant. The essence of this technology is to adjust the oxygen level in LBE coolant so that a self-healing protective oxide film can grow on the surface of the structural materials to prevent corrosion, while no excessive oxygen is available to form solid admixtures (mostly lead oxide). The Russians successfully deployed this technology in their nuclear submarine reactors and have over 70 reactor-years (150 MWt units) of experience [10].

In the US, Brookhaven National Laboratory first tried to use liquid lead-bismuth as a coolant, attempting to protect the container walls from corrosion by adding inhibitors, such as zirconium, possibly forming a surface layer of zirconium nitrate or carbide [11]. This solution was not satisfactory because of the difficulty in maintaining a consistent protective layer during operations. After extended study, the US project for a lead-cooled submarine reactor was abandoned.

The surfacing of viable Russian lead technology is opening the door to the possible commercial use in power producing nuclear plants. Russian designs for small (100MWt) and large (1000MWt) reactors are being evaluated. It is widely believed that these designs obviate many of the problems inherent to sodium-cooled reactors, such as positive void coefficients and fire hazards.

## **6. AN IMPLEMENTATION SCENARIO**

The dedicated nature of ATW and the flexibility afforded by subcriticality combined to give us many possibilities for implementing ATW for effective waste destruction. We will examine one possible implementation scenario. Many others can be developed similarly [9].

### **6.1 Spent Fuel Backlog Transmutation in 65 Years**

By the year 2015, there will be 70,000 tons of US spent fuel containing about 600 tons of plutonium and higher actinides requiring disposal. The ATW objective is to treat the spent fuel backlog, destroy the transuranics and selected fission products, and prepare the resulting waste for permanent disposition in a geologic repository within a relevant time horizon.

Twenty one ATW systems are brought on line to accomplish the objective over a 65 year period. Each ATW system consists of an accelerator (1 GeV, variable current 20-40 mA), a subcritical 2000 MWt LBE burner, and a pyrochemical plant (50 tons/year throughput per burner). Several of these ATW systems could be located together in one facility, and we have examined the possibility of having three ATW facilities. The parameters for the ATW burners are as follows:

*Fission Power: 2000 Mwt; Thermal to electric efficiency : 40% ;  
Power to Grid: 700 MWe; Recirculated power: 100 MWe (67 to accelerator, 33 to plant operations);  
Operational TRU Inventory: 3000 + 1000 kg; Conversion Ratio: 0.0; Process losses: 1/1000;  
TRU Burn Rate: up to 650 kg/yr.; TRU Burn efficiency (Rate/inventory): 16.25% .*

Of particular relevance is the fact that each 2000MWt ATW burner can destroy up to 650 kg of actinides (plutonium and transuranics) per year, and that 700 MWe would be available for distribution to the grid from each burner, after powering the driving accelerator and the plant. In the three-facility scenario, every four years a new ATW system is brought on line at each site. As the burners and accelerators reach the end of their operational life, they are decommissioned, and the fuel from the decommissioned burner is sent to feed other still operational burners. Eventually, the last system in operation at each site will receive all the remnant waste and destroy it down to less than 1 ton over a protracted (5 years) inventory burn-down period (Fig. 5,6).

There are two major characteristics of the ATW that distinguish the accelerator-driven subcritical systems from critical reactors that had been evaluated for actinide destruction, such as the ALMR: (1) ATW does not produce higher actinides from a fertile material such as U-238; (2) because ATW is not constrained by a criticality requirement it can burn down the end-of-life (EOL) actinide inventory to as low a level as desired and practical.

### **6.2 Cost considerations for the burn-down scenario**

In general the following key points are known about the cost of an ATW system:

- the cost of the particle accelerator will not dominate the economics of ATW;
- the pyrochemical waste treatment processes are acknowledged to be less expensive than traditional aqueous chemistry processes [8];
- the cost of subcritical ATW burners based upon lead/bismuth coolant technology should be comparable or lower to the cost of critical sodium-cooled reactors;
- electricity produced by the ATW plant could offset operating costs and produce revenue.

Including a possible reduction in the cost of the repository introduced by ATW, it is reasonable to conclude that the economic prospects for ATW are encouraging, possibly providing an economic gain along with its other benefits.

## **7. CONCLUSIONS**

ATW destroys virtually all the plutonium and higher actinides without reprocessing the spent fuel in a way that could lead to weapons material diversion. Once demonstrated and developed, ATW could be an essential part of a global non-proliferation strategy for countries that could build up large quantities of plutonium from their commercial reactor waste. ATW technology, initially proposed in the US, has received wide and rapidly increasing attention abroad, especially in Europe and the Far East, with major programs now being planned, organized and funded. Substantial convergence presently exists on the technology choices among the programs, opening the possibility of a strong and effective international collaboration on the phased development of the ATW technology.

If the job of nuclear waste destruction has to be done quickly, safely, and with reasonable investment, we believe that a dedicated, once-through subcritical burner (ATW) system would provide the most effective option. ATW can provide, within a realistic nuclear technology envelope, a way to destroy the undesired products of nuclear energy generation. This is a new instrument in the field of nuclear systems: it could accomplish the destruction of all transuranics (including plutonium) and long lived fission products, or only a residual portion, if recycle of Pu in existing critical reactors is deemed acceptable. The technologies introduced and developed for ATW (liquid lead/LBE nuclear coolant, pyrochemical processes, high power accelerators) will also have important applications to, and could well constitute the backbone of future nuclear systems (both critical and sub-critical).

ATW systems could be used in a series of different scenarios, including the expanded, sustained or declining use of nuclear power. The ability to demonstrate such a flexible means of destruction of waste will be very important in fostering the confidence that a "forever" legacy of waste is not the unavoidable consequence of having once used nuclear power, or by the same token in promoting the acceptance of nuclear power as a viable and environmentally sustainable large-scale energy source.

## **8. ACKNOWLEDGMENTS**

The authors wish to thank Wolfgang Barthold and Mario Carelli for important contributions to the ATW concept. This research is funded by Los Alamos National Laboratory LDRD. The internal Los Alamos Report number for this paper is LA-UR 98-985.

## **9. FURTHER READING**

- [1] Committee on Separations Technology and Transmutation Systems, *"Nuclear Wastes: Technologies for Separations and Transmutations."* Nat. Academy Press, Washington, DC, 1996
- [2] G. Michaels, "Potential Benefits of Waste Transmutation to the U.S. High-Level Waste Repository", AIP Conference Proceedings 346: Int'l Conf. on Accelerator-Driven Transmutation Technologies and Applications, 8 (1995) and references therein.
- [3] C.D. Bowman *et al.*, "Nuclear Energy Generation and Waste Transmutation using an accelerator-driven intense thermal neutron source." Nuclear Instr. and Methods A230, 336 (1992).
- [4] C. Rubbia, "A high gain Energy Amplifier operated with fast neutrons", same as [2]
- [5] D.C. Christensen, L.J. Mullins, "Plutonium Metal Production and Purification at Los Alamos," in *Plutonium Chemistry*, Carnall and Choppin, Eds. Am. Chem. Soc., Washington D.C., 409 (1983)
- [6] J.J. Laidler, J.E. Battles, W.E. Miller, and E.C. GAY, "Development of IFR Pyroprocessing Technology," in *Proceedings of Global '93*, (1993).
- [7] M.A. Williamson, "Chemistry Technology Base and Fuel Cycle of the Los Alamos Accelerator-Driven Transmutation System," in *Proceedings of Global '97*, 263 (1997).

- [8] Burns and Roe Company, "*ALMR - Fuel Cycle Facilities, Design Report and Cost Estimates*", GEFR-00942, BRC-448 (1995).
- [9] F. Venneri *et al.*, "*Accelerator-driven Transmutation of Waste (ATW) Technical Review at MIT*", LANL Report, LA-UR-98-608.
- [10] Communications and contract reports from the Institute of Physics and Power Engineering (Obninsk) and EDO-Gidropress (Podolsk), Russia.
- [11] J. R. Weeks and C. J. Klamut, *Nucl. Sci. Eng.* **8**, 133 (1960).

# Agenda for Two Days

---

## Thursday

- 08:45 -09:30 Welcome and Introduction S. Schriber
- 09:30 -11:30 ATW Overview F. Venneri
- 11:45 -13:15 ATW Demonstration Conceptual Characterization  
M. Carelli, Westinghouse STC
- 14:00 -15:00 ATW Nuclear Performance M. Houts
- 15:15 -17:15 ATW Process M. Williamson; A.  
Schake

## Friday

- 08:30 -09:30 Accelerator Design for ATW G. Lawrence
- 09:30 -12:15 Liquid Lead Technology Y. Orlov, IPPE; N.  
Li; K. Woloshun
- 12:15 -13:15 Program Plan and Summary F. Venneri
- 14:00 -15:00 Bechtel, N-G, Sandia, LLNL

**LANSGE**

# Charge

---

---

**Comment on ATW technology choices and status.**

**Provide feedback on where emphasis should be given within the program.**

**In what areas do you have concerns and issues? What recommendations do you have?**

**Comment on five year program -- elements, goals and possible accomplishments.**

***“Reducing the Impact of Nuclear Waste”***

# ***ATW Overview***

Francesco Venneri  
ATW Project Leader

***Los Alamos National Laboratory***  
***-- ATW Project --***



*ATW addresses SPENT FUEL MANAGEMENT issues:*

- ***Plutonium Accumulation***
- ***Long-term Uncertainties***
- ***Efficient use of Resources***

## ***How ATW assists Nuclear Waste Management***

- *Efficient destruction of transuranic waste produced in reactors*
- *Transmutation of long-lived fission products of impact to repository performance*
- *Full utilization of energy content in nuclear waste for power production*

# **TRANSMUTATION OF NUCLEAR WASTE !!??**

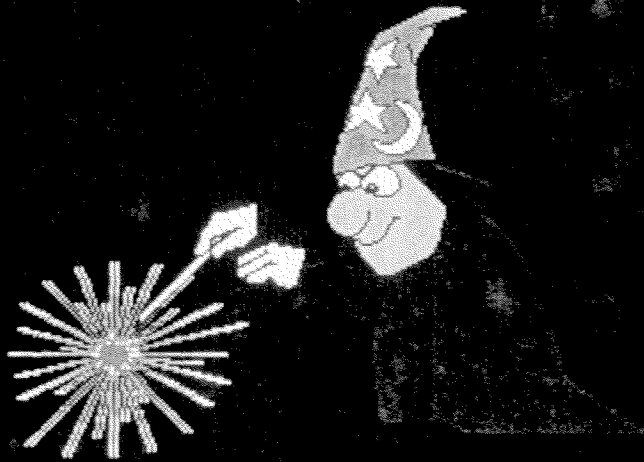

## ***ATW and spent fuel: what, why***

<i>why: what:</i>	<i>water solubility and transport</i>	<i>criticality</i>	<i>source term</i>	<i>diversion</i>	<i>problem daughters</i>	<i>heat</i>
<i>Cladding</i>	---	---	<i>low</i>	---	---	---
<i>Uranium</i>	<i>high</i>	<i>low</i>	<i>low</i>	<i>low</i>	<i>high</i>	<i>low</i>
<i>Plutonium</i>	<i>low</i>	<i>high</i>	<i>high</i>	<i>high</i>	<i>high</i>	<i>high</i>
<i>Neptunium</i>	<i>high</i>	<i>low</i>	<i>high</i>	<i>high*</i>	<i>high</i>	<i>low</i>
<i>Other Act.</i>	<i>low</i>	<i>low</i>	<i>high</i>	<i>low</i>	<i>high</i>	<i>high</i>
<i>Tc, I</i>	<i>high</i>	---	<i>low</i>	---	---	<i>low</i>
<i>Sr, Cs</i>	<i>high*</i>	---	<i>high*</i>	---	---	<i>high*</i>
<i>Noble metals</i>	<i>low</i>	---	<i>low</i>	---	---	<i>low</i>
<i>Lanthanides</i>	<i>low</i>	---	<i>low</i>	<i>low</i>	<i>low</i>	<i>high*</i>
<i>Volatiles</i>	---	---	<i>high</i>	---	---	<i>low</i>

## **ATW and spent fuel: how**

<b>Cladding</b>	<i>ATW plans to use the LWR cladding material (zircalloy) as matrix for its fuel elements (80-90% Zr atom fraction with remainder transuranics).</i>
<b>Uranium</b>	<i>Uranium is separated from spent fuel, for future use in reactors or disposal.</i>
<b>Plutonium</b>	<i>All plutonium isotopes are fissioned. Diversion concerns are eliminated. Long term heat source is eliminated.</i>
<b>Neptunium</b>	<i>Neptunium is destroyed. <math>^{237}\text{Np}</math> is the worst contributor to aqueous dose releases.</i>
<b>Minor Actinides</b>	<i>ATW destroys all minor actinides together with plutonium and neptunium. No buildup of heavy actinides occurs</i>
<b>Technetium, I</b>	<i>ATW isolates technetium (we know how to do this) and iodine (we are working on it) and transmutes them into stable elements. No isotope separation is required.</i>
<b>Strontium, Cs</b>	<i>ATW separates Strontium and Cesium (high heat producers). These are stored in optimized engineered wasteforms. - short term large heat release rate has no effect on the remainder wasteforms containing longer half-life residuals</i>
<b>Noble metals Lanthanides Volatiles</b>	<i>ATW separates the noble metals, lanthanides and volatiles into specific wasteforms.</i>

# Effect of Transmutation on Thermal Power of spent LWR fuel

0.1% cumulative process losses

based on ORNL DWG 92A-242

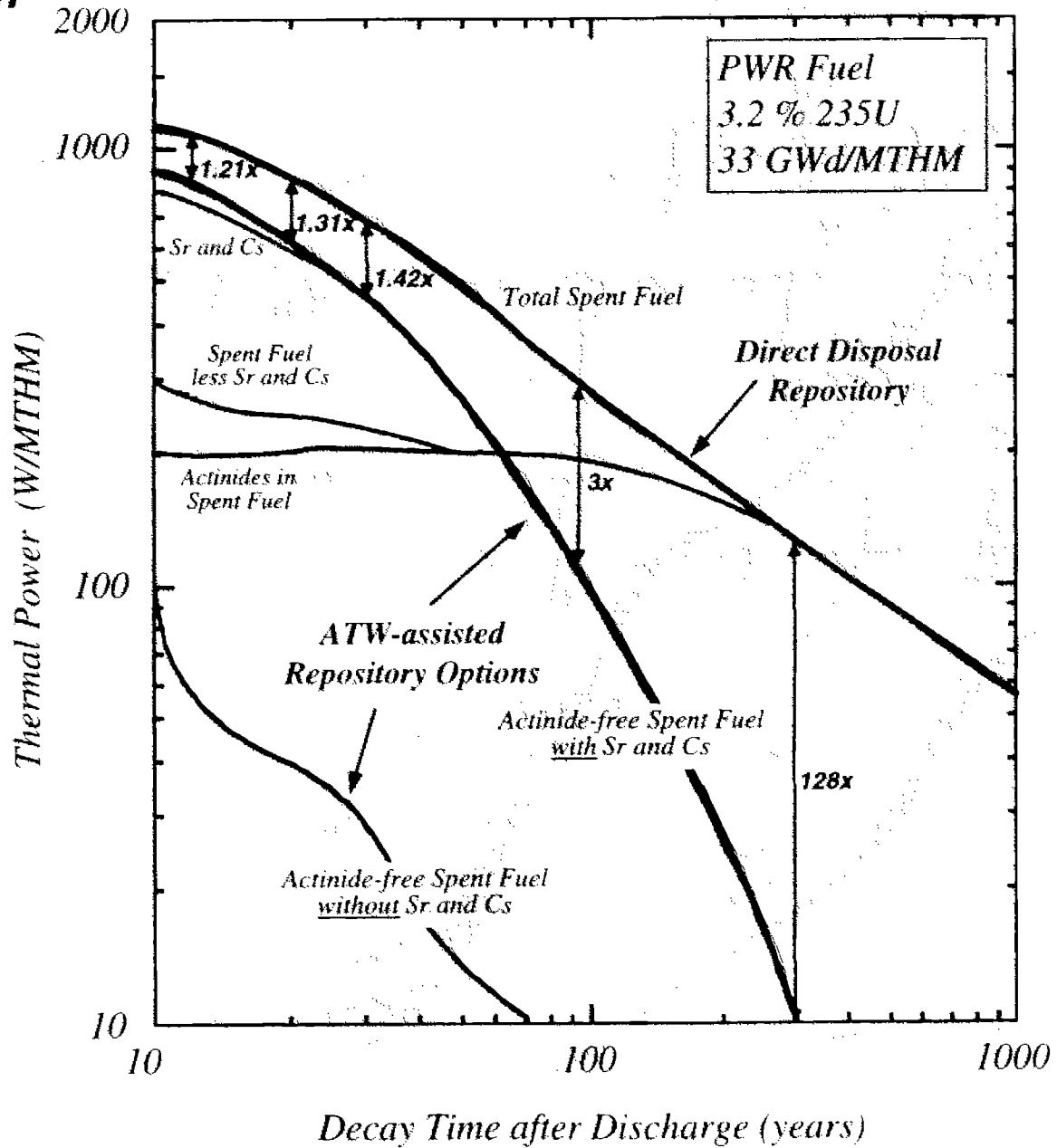

# Effect of Transmutation on Ingestion Toxicity of spent fuel

0.1% cumulative process losses

PWR Fuel  
3.2%  $^{235}\text{U}$   
33 GWd/MTHM

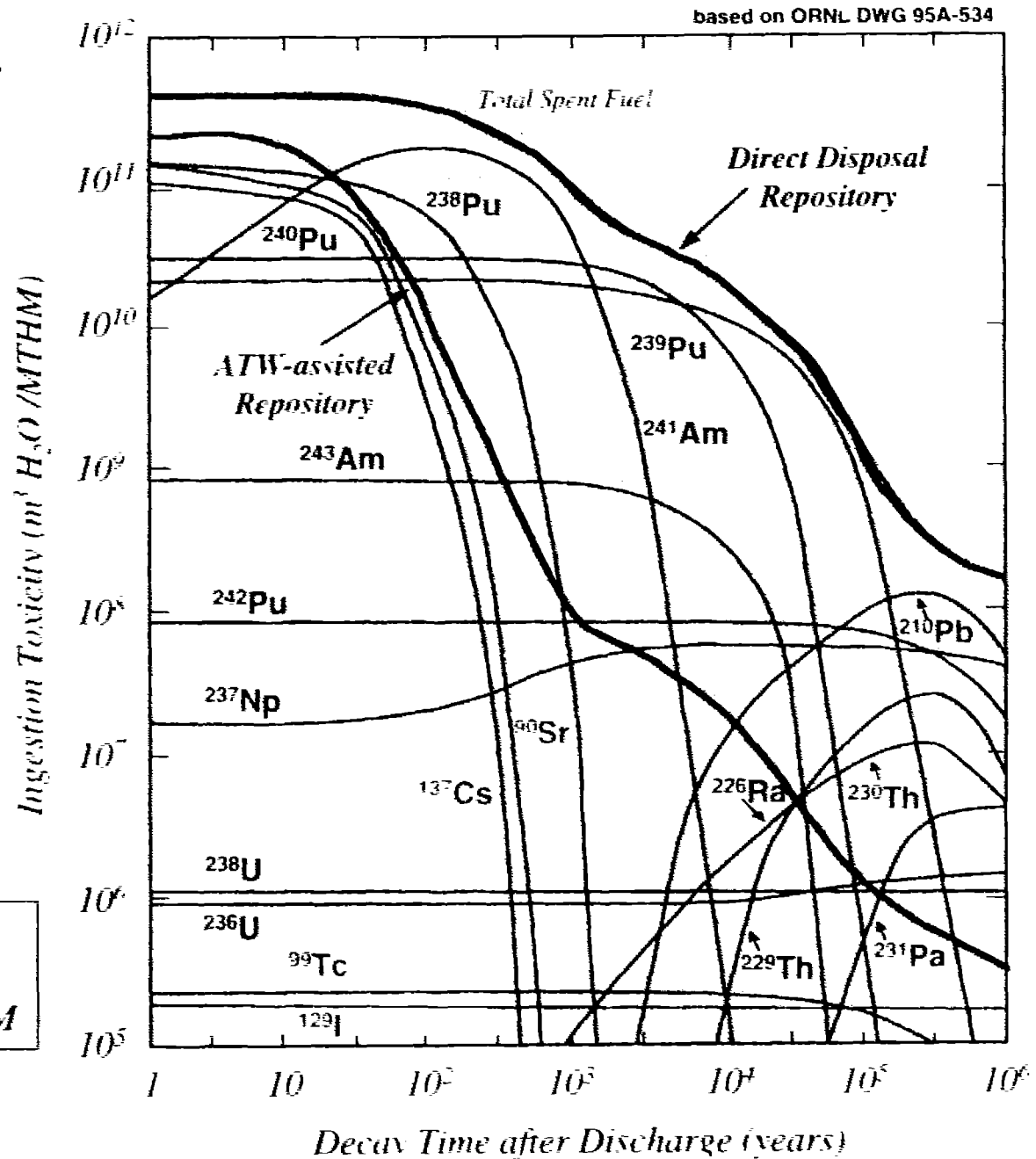

## ***ATW features that make a difference in dealing with nuclear waste destruction***

- ***no new TRU production via neutron capture***
- ***near-complete burndown of TRUs at end of life***
- ***low-loss fuel recycle processes***



## ***ATW compares favorably to other S+T schemes:***

- ***ATW has better transmutation performance***  
*faster, more complete, requires smaller investment*
- ***ATW has simpler processing requirements***  
*smaller number of steps, more proliferation resistant, less waste*

*details will be provided in the course of the Review*

# ***Performance Drivers in the ATW concept design :***

## ***Fast Burn Rates, Low Inventories***

*Capability for rapid materials inventory reduction  
Minimized economic impact*

## ***Safety***

*Engineering design clarity, defense in depth.  
inherent safety*

## ***Proliferation Resistance, Low Environmental Impact***

***Restrains .... (Constraints)***

***No Liquid Fuel***

***No On-line Processing***

*Drivers provide basis for ATW systems and technology choices*

***Fast Burn Rates,  
Low Inventories***

*Fast Spectrum, Subcritical Operation,  
Variable Current Drive, EOL burndown,  
Conversion Ratio = 0, Tc burnable poison*

***Safety***

*Liquid lead-bismuth coolant/target, solid  
fuel*

***Proliferation Resistance,  
Low Environmental Impact***

*Limited Batch Pyroprocessing*

*Fast spectrum operation offers considerable neutronic advantages*

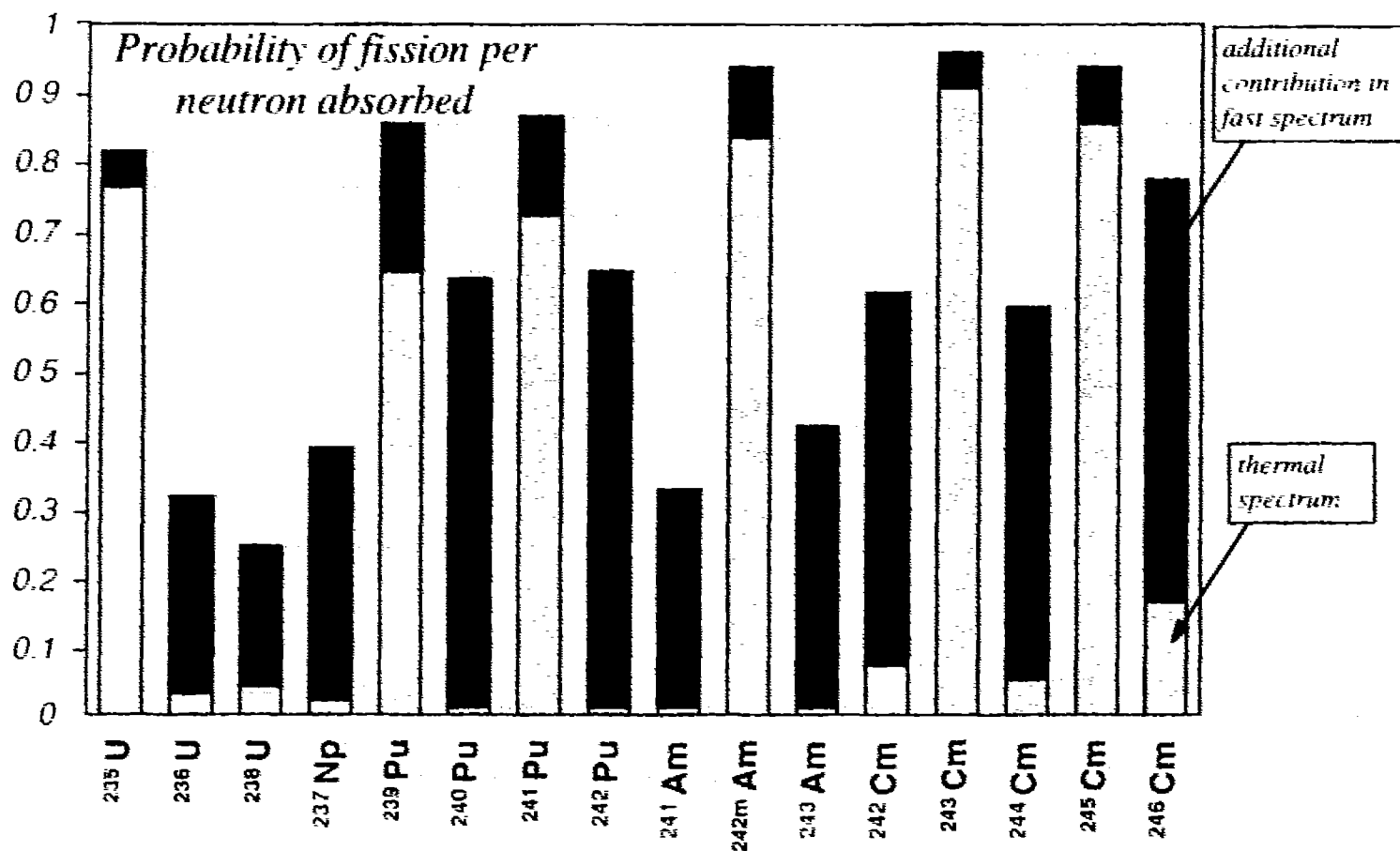

- Efficient neutron production and utilization
- Avoidance of buildups of the very high actinides (Am, Cm, Bk, Cf)
- Fast spectrum eliminates need for rapid fission-product poison removal
- Leakage neutrons can be thermalized for FP transmutation (if necessary)

# Accelerator Drive (Subcriticality) enables versatile and effective Nuclear Waste Destruction

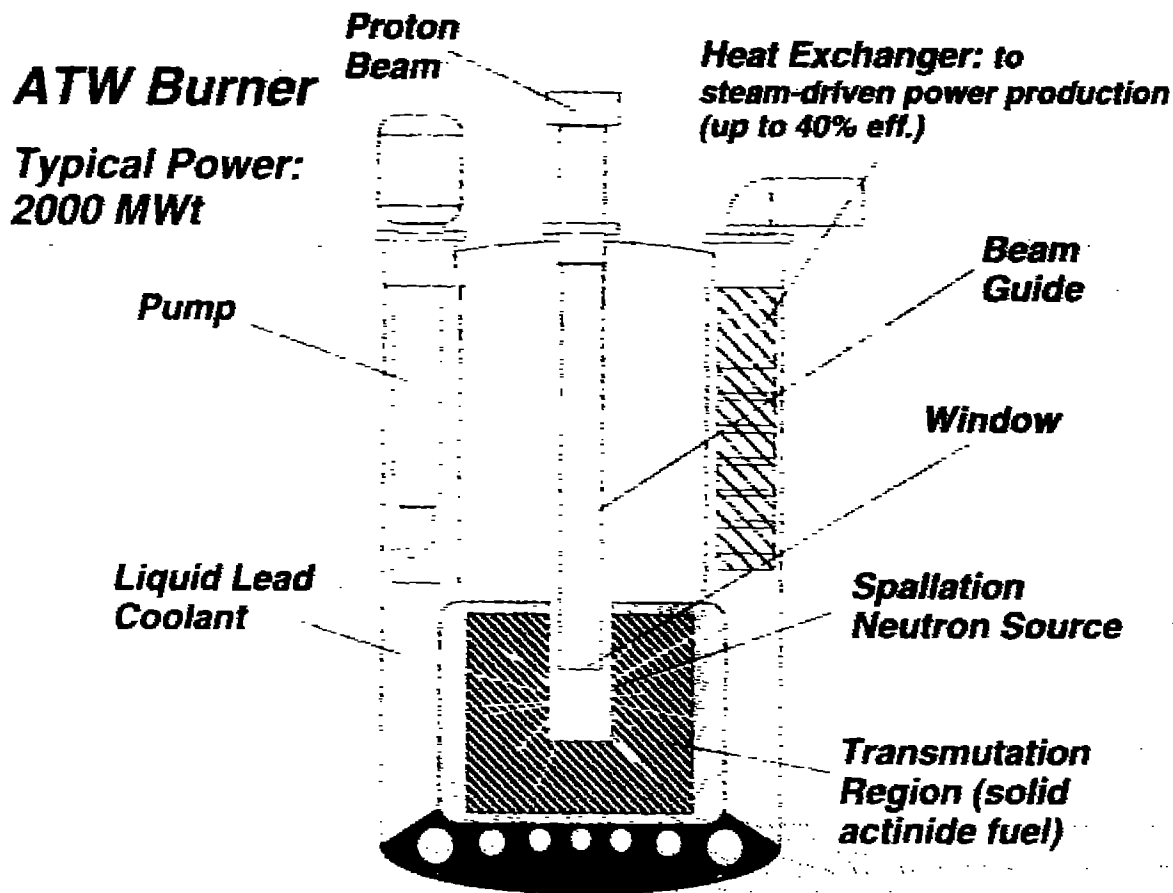

why subcriticality has advantage for waste destruction:

- **Power control is not linked to reactivity feedbacks, delayed neutrons or to control rods, but only to the accelerator drive**
- **ATW has no need for fertile materials. ATW uses pure transuranic cores.**
- **Subcritical systems work independently of the fuel composition**
- **EOL inventory is not limited by criticality. Possible to have EOL burndown of inventory**
- **Neutronics and thermohydraulics are effectively decoupled**

*Core Map for 1000 MWt  
ATW DEMO*

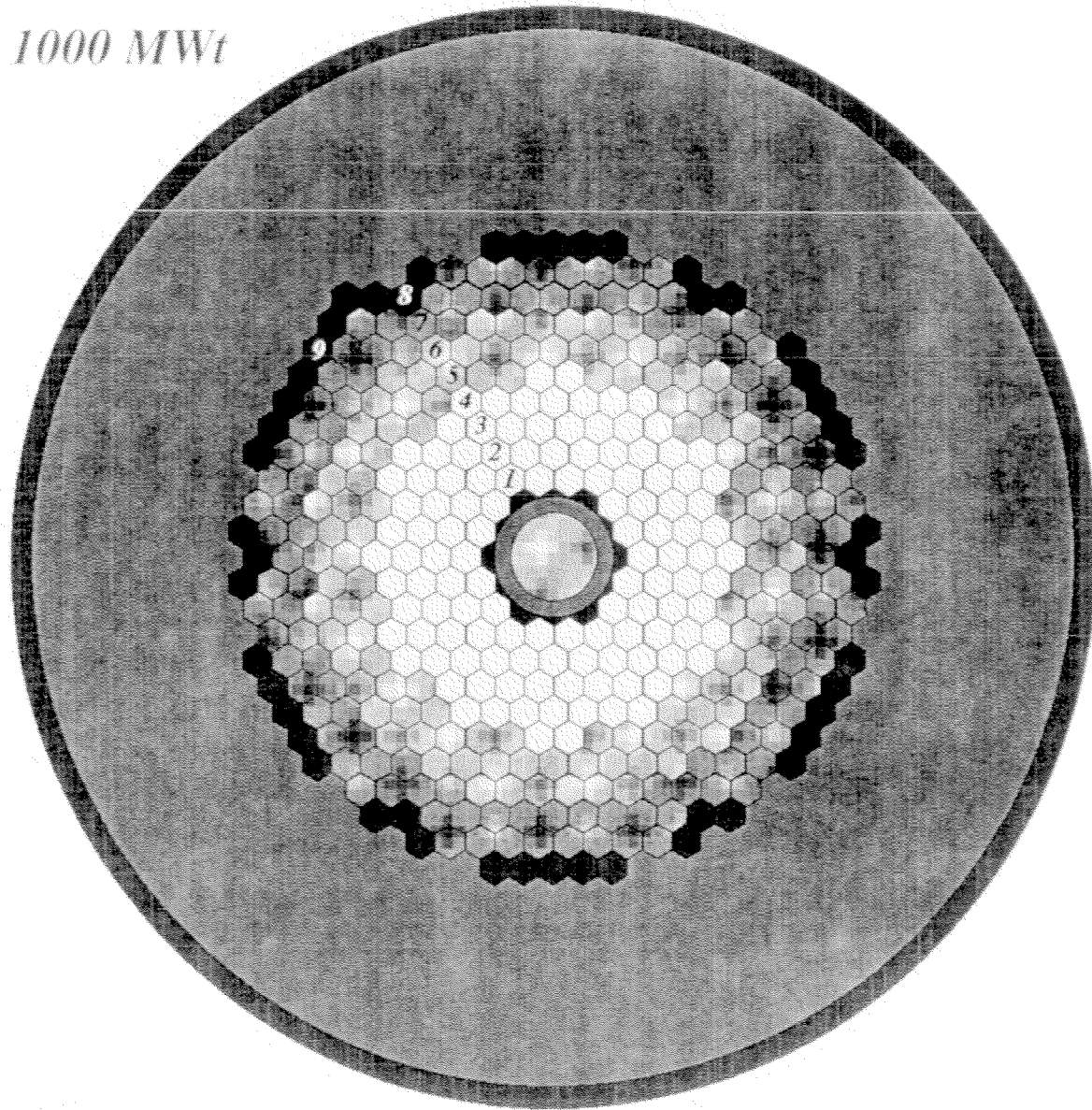

300 cm

*Core Map for 2000 MWt  
ATW Burner*

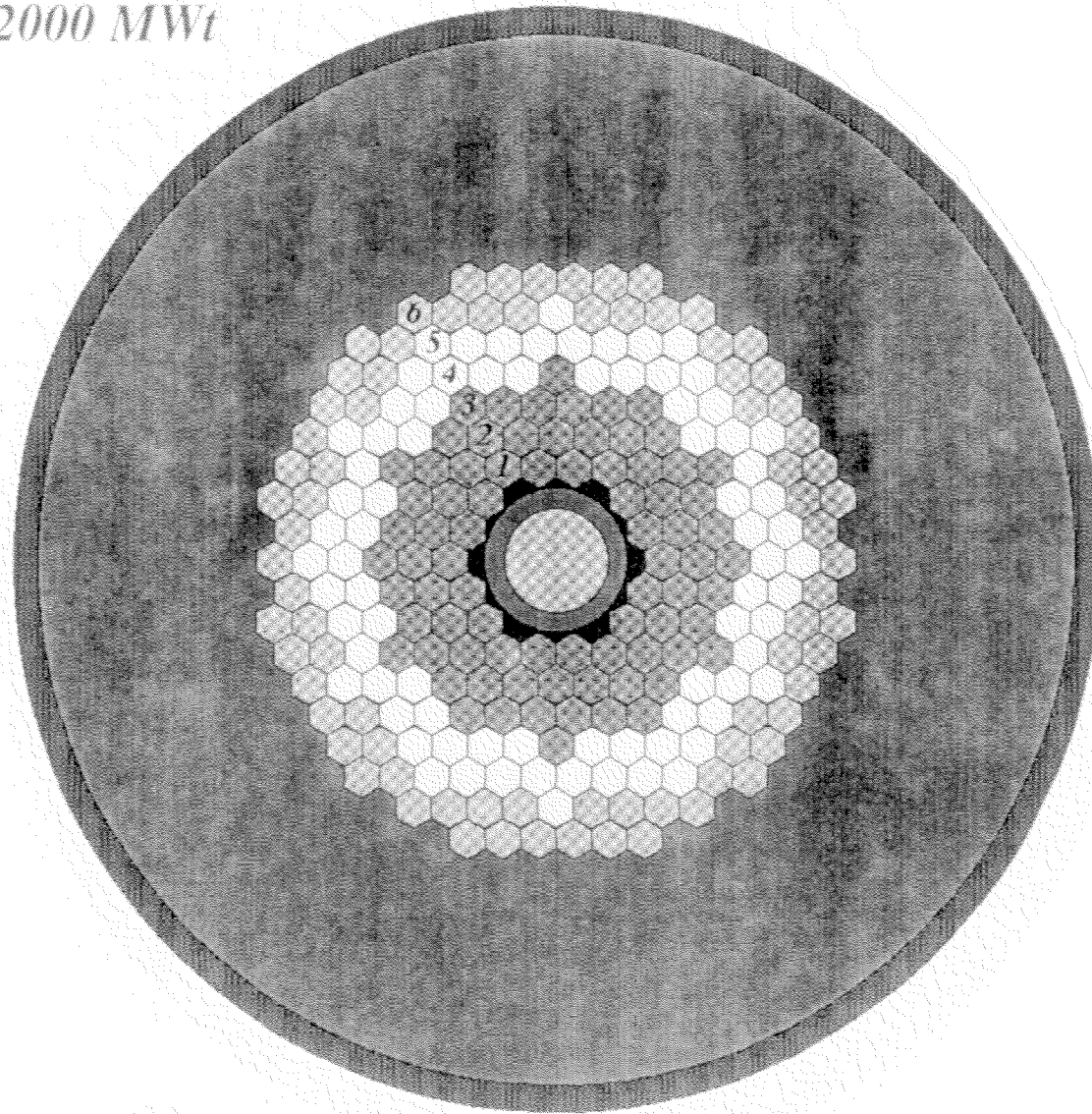

200 cm

1000 MWt  
1000 MWt

***The insertion of 1.0\$ of reactivity in ATW systems only increases the steady state power level by ~5%***

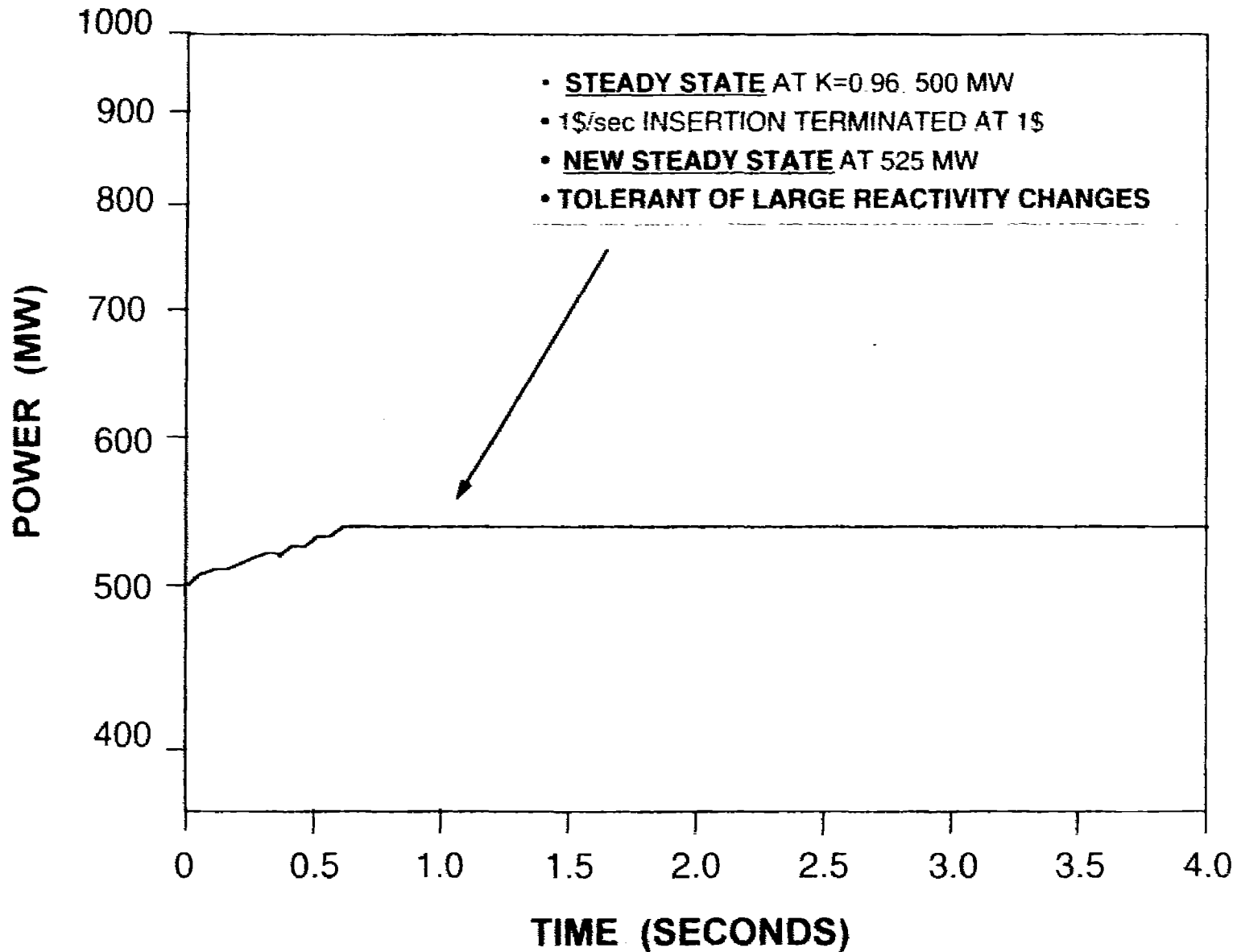



# Increased coolant temperature

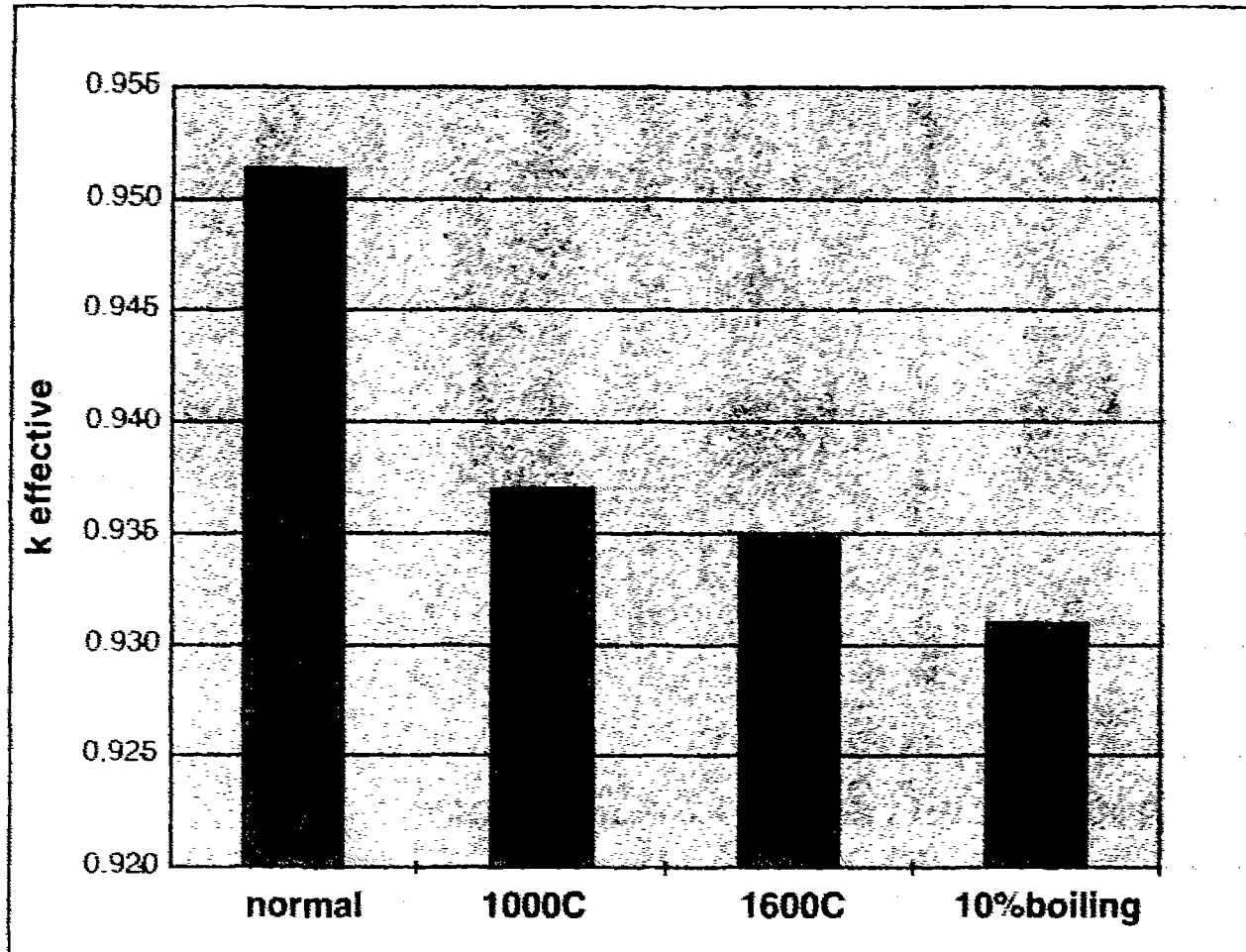

*Because of slow and self limiting response to reactivity changes, and because of strong negative feedback of coolant temperature, ATW can use cores with little or no negative Doppler (high fraction of transuranics)*

# ***Variable accelerator drive provides constant power operation under extended burnup, without fertile materials***

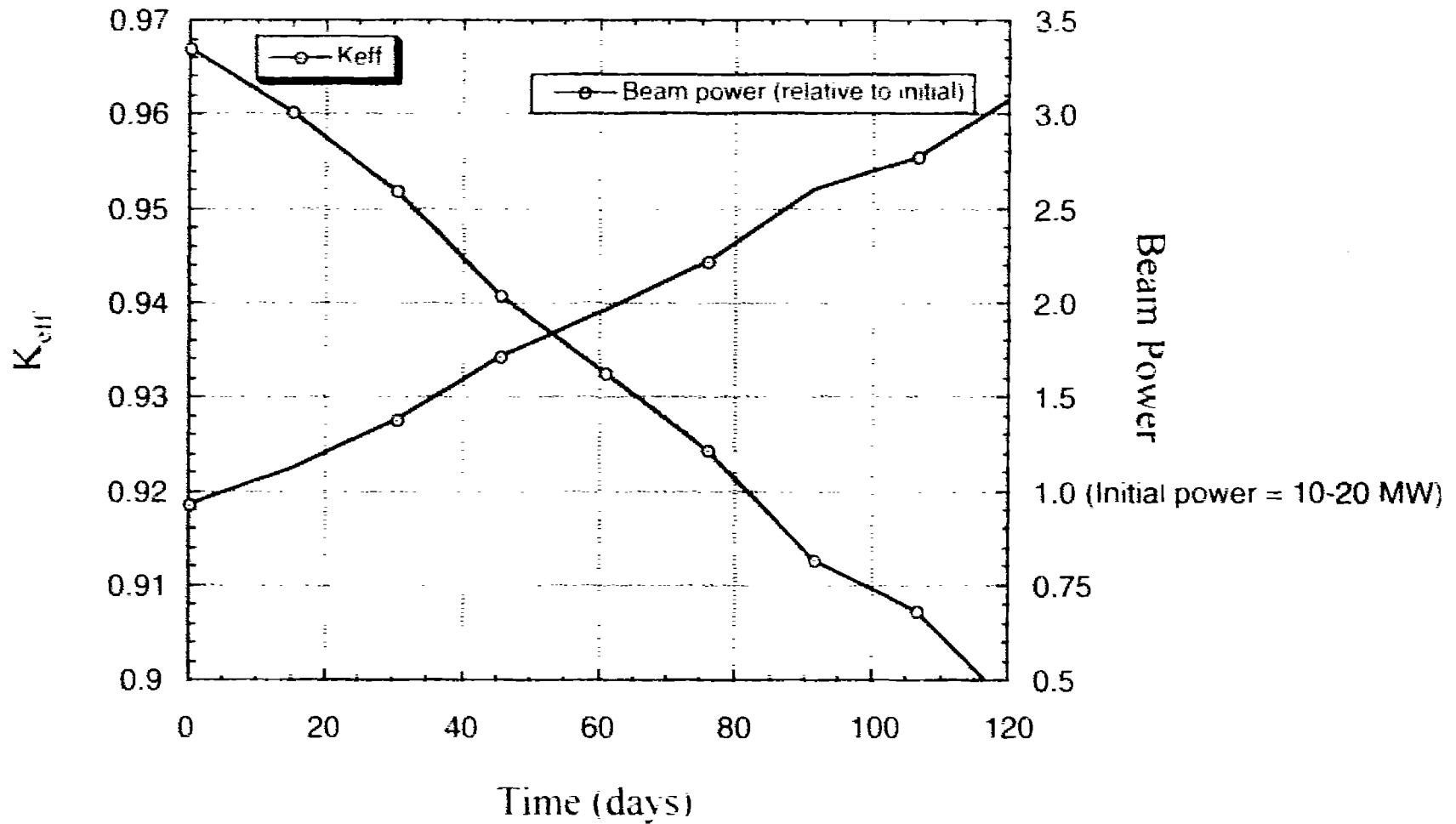

*.... we don't have to resort to liquid fuels*

# ***Tc as Burnable "Poison"***

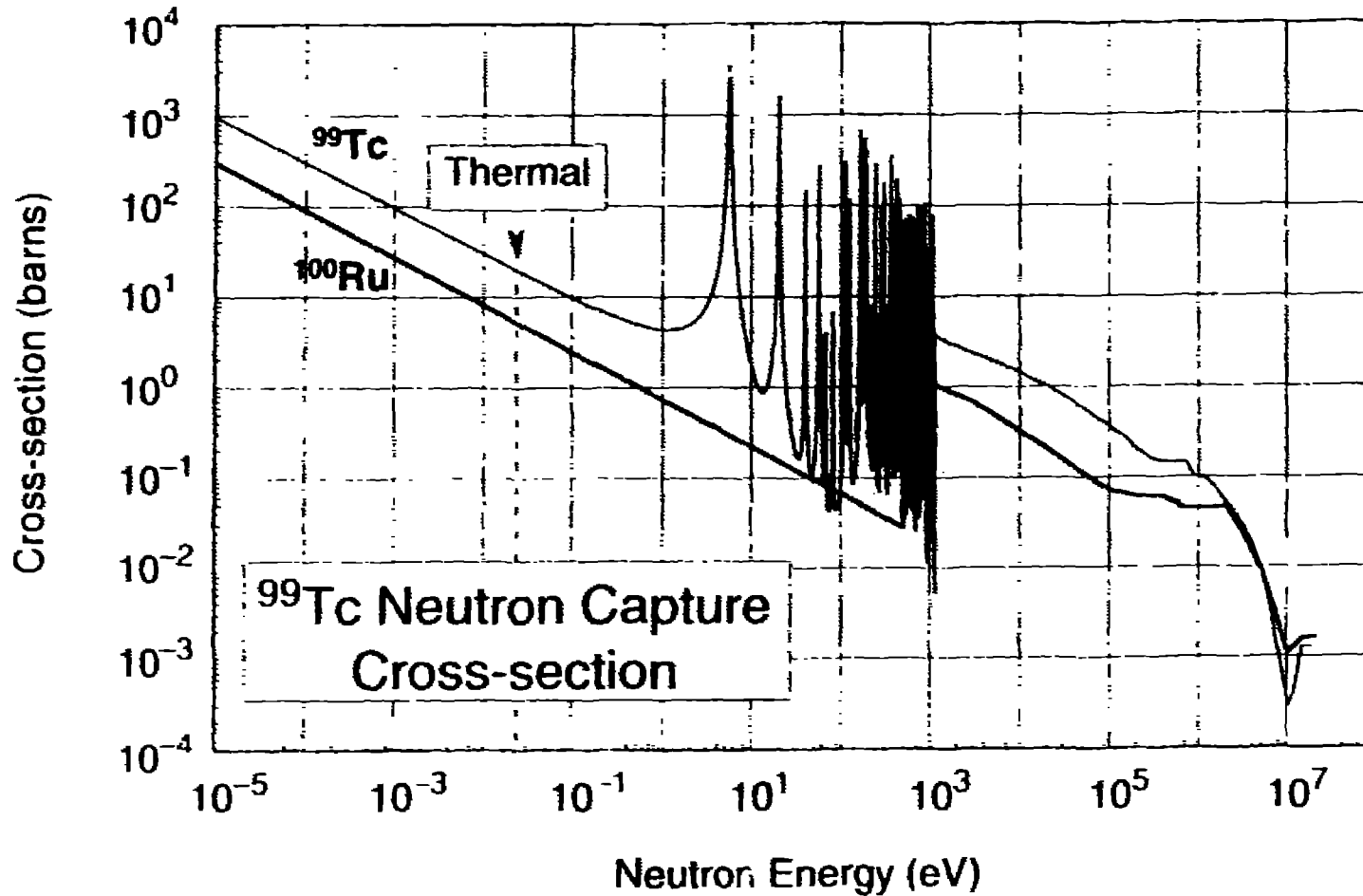

*Molybdenum-Techneium alloy can be cast into rods suitable for irradiation (other possible)  
Ruthenium does not need to be processed because of low cross section*

# ***ATW Fuel Elements***

*Drivers: non-fertile actinide based fuel, high melting point. compatible with pyrochemical processes. recycle of waste material, existing experience.*

*Selection: Transuranic metal fuel in inert Zirconium matrix.*

- **composition**                      **85-90% Zirconium,                      10-15% Transuranics**
- **melting point**                      **~ 1400 °C**
- **316 SS clad, lead bond (He also possible)**
- **excellent solubility of actinides in Zr phase**
- **phase equilibria established**
- **prepared by vacuum casting**
- **utilizes zircalloy discard cladding from spent fuel**
- **considerable experience exists with metallic fuel**
  - ~ 80%Zr 20%U *Naval Fuel*
  - ~ 75%U 15%Pu 10% Zr *IFR Fuel*

## ***Issues:***

**Irradiation Behavior**

**Swelling**

**Bonding compatibility**

**Fuel bundle geometry**

*.... Backup: Oxide fuel*

## *The choice of liquid lead/bismuth (LBE):*

- 1. Very hard neutron spectrum*
- 2. No violent reactions with air or water*
- 3. Low melting, high boiling points. Low vapor pressure. Large  $\Delta t$ . possible.*
- 4. Excellent medium for natural convection (essential for passive safety)*
- 5. Very low neutron absorption. Large P/D ratios are possible. Very low core pressure drops*
- 6. Materials compatibility established*
- 7. Very effective gamma shielding material and spallation neutron source*

*Early problems with LBE nuclear systems (corrosion of structural materials, oxygen balance, handling of Polonium) have been successfully solved (Russian experience)*

***LBE systems are a natural choice for subcritical configurations driven by accelerator beams. LBE is an excellent spallation neutron source and nuclear coolant. One-fluid systems can be readily designed.***

*ATW uses the same fluid for target and core cooling -- no target structure*

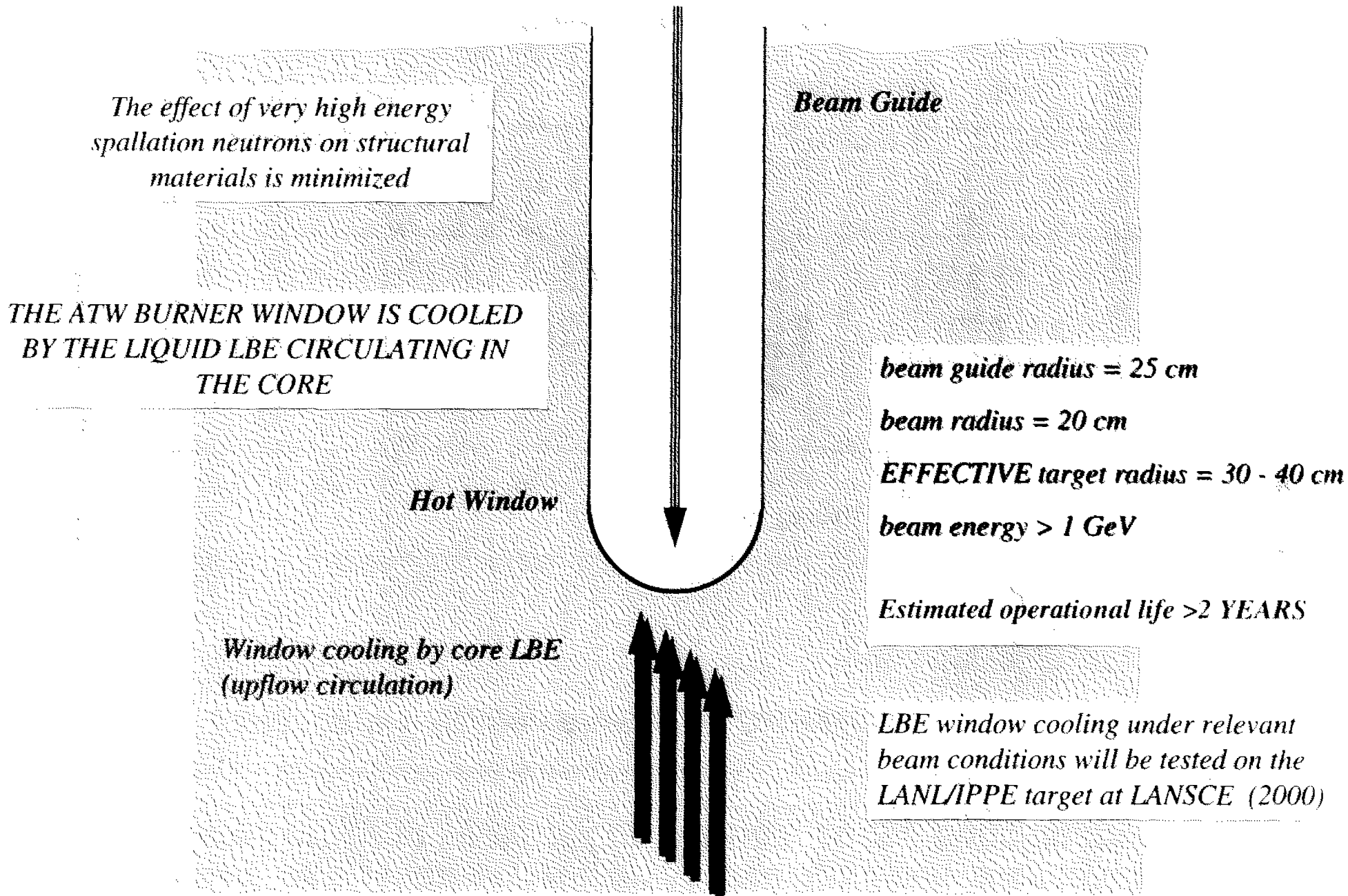

**Lead as spallation neutron source has been successfully tested on large scale at Los Alamos, codes benchmarked**

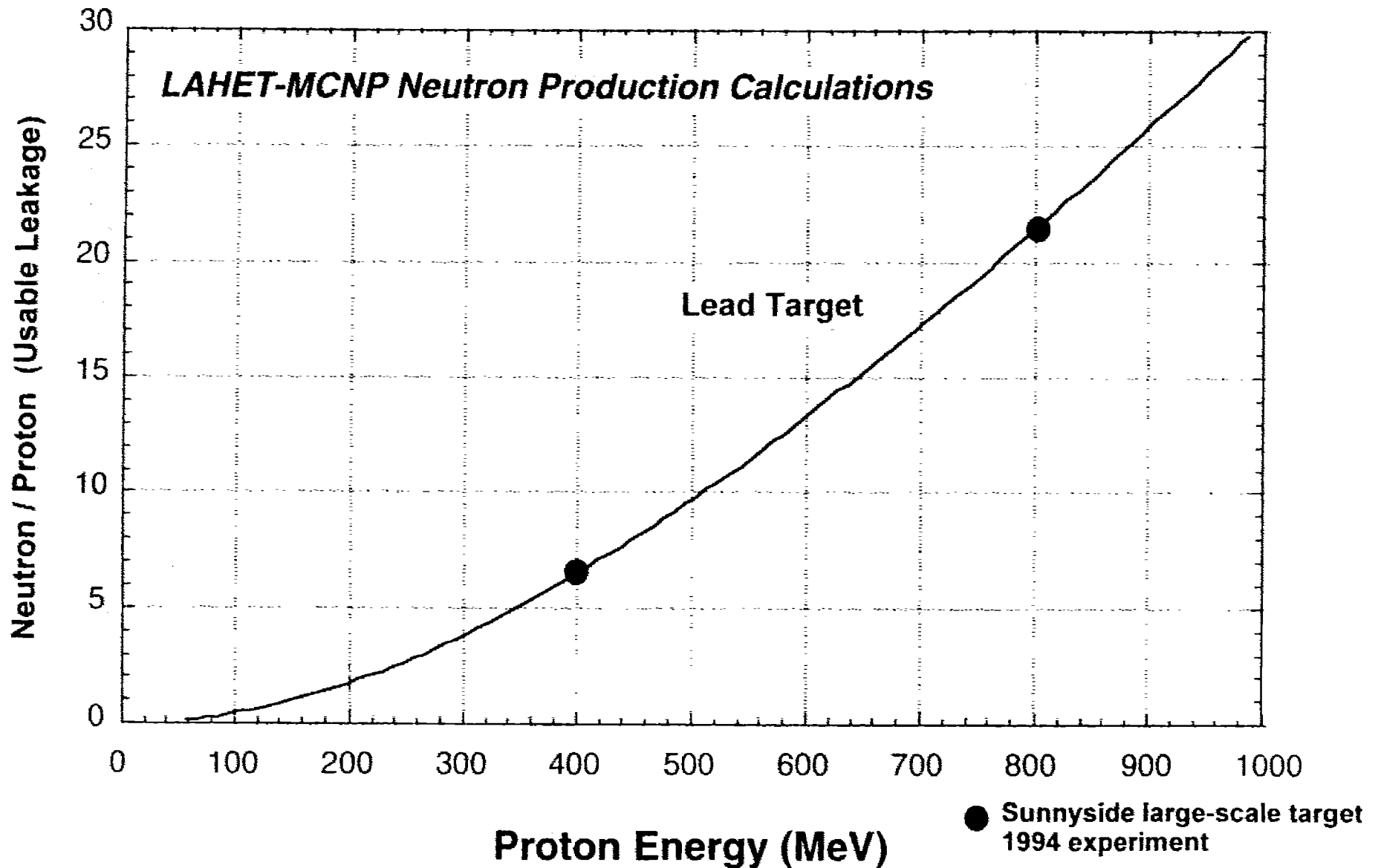

*Spallation residual nuclei production is less than 200g/MW-yr of beam*

## Residual nuclei per incident 1 GeV proton on LBE

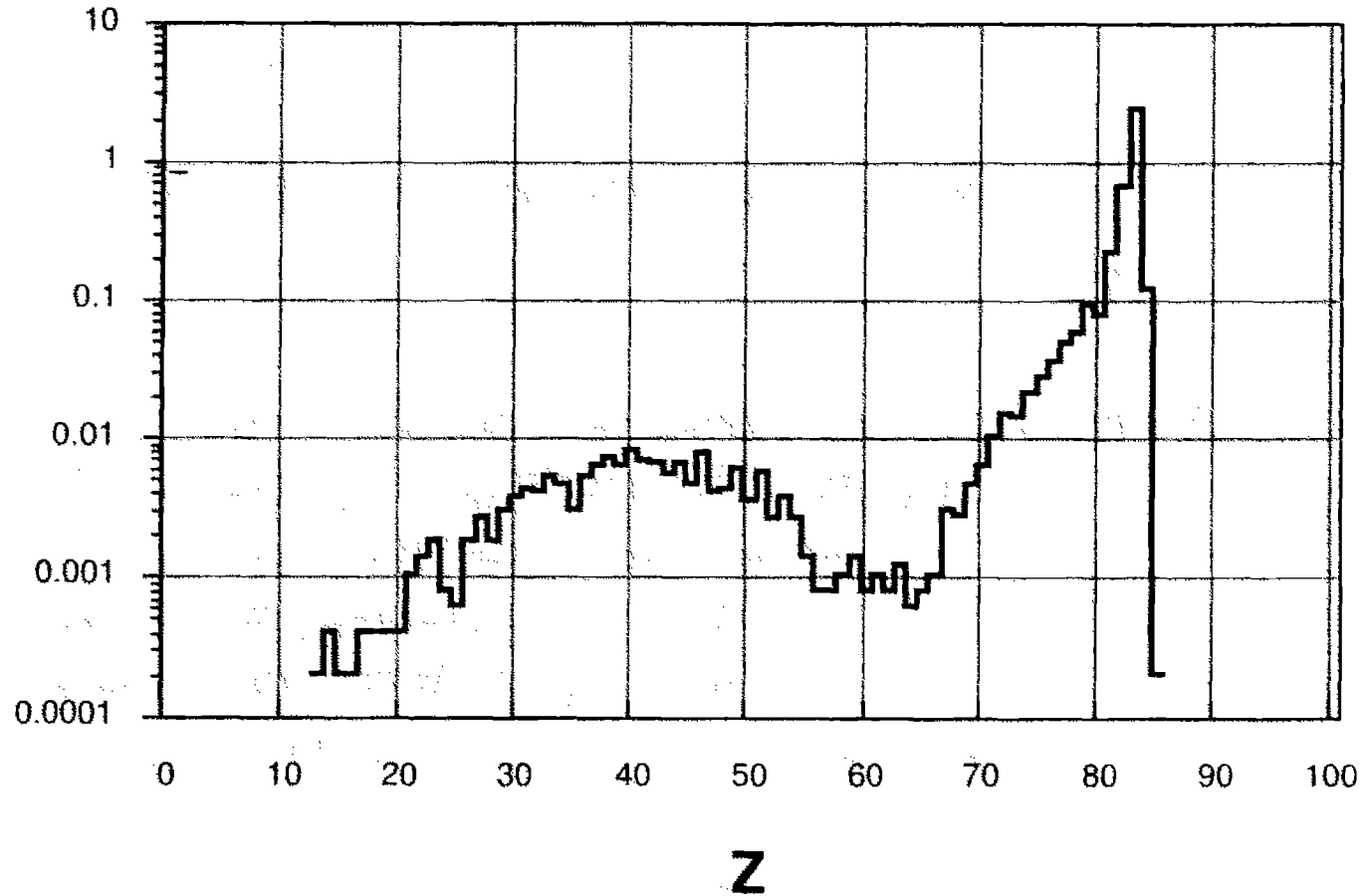



# *Design Objectives for ATW Accelerator*

---

*A linac for an ATW facility should be designed:*

- To have very high electrical efficiency (ac to beam power)*
- For minimum capital and operating costs*
- For minimum spatial footprint (short length)*
- To vary the power on target over a wide range*
- To have high availability and operational flexibility*
- To use the best mix of established technology (APT) and anticipated technology advances*

*--- High-Gradient Superconducting (HGSC) Linac*

*Nominal beam parameters:*

*40 MW proton beam*

*1000 MeV 40 mA 100% duty*

***THE CHOICE OF PYROCHEMISTRY :***  
***Waste Treatment Technology***

**The OBJECTIVES:**

- **Rough separation of Uranium (95-99%) from the spent fuel prior to introduction in the ATW burner**
- **Periodic recycle of the ATW fuel during operations**
- **Periodic cleanup of the processing medium**
  
- **PYROCHEMISTRY ALLOWS FAST, BULK-TYPE SEPARATIONS.**
- **IT IS NOT ADVERSELY AFFECTED BY HEAT OR RADIATION.**
- **IT PRODUCES VERY LOW AMOUNTS OF SECONDARY WASTE.**

**NONE OF THE PROCESSES PROPOSED PRODUCES "NAKED" PLUTONIUM.**

# ATW Waste Treatment is based on Pyrochemical Processes developed at Los Alamos and Argonne

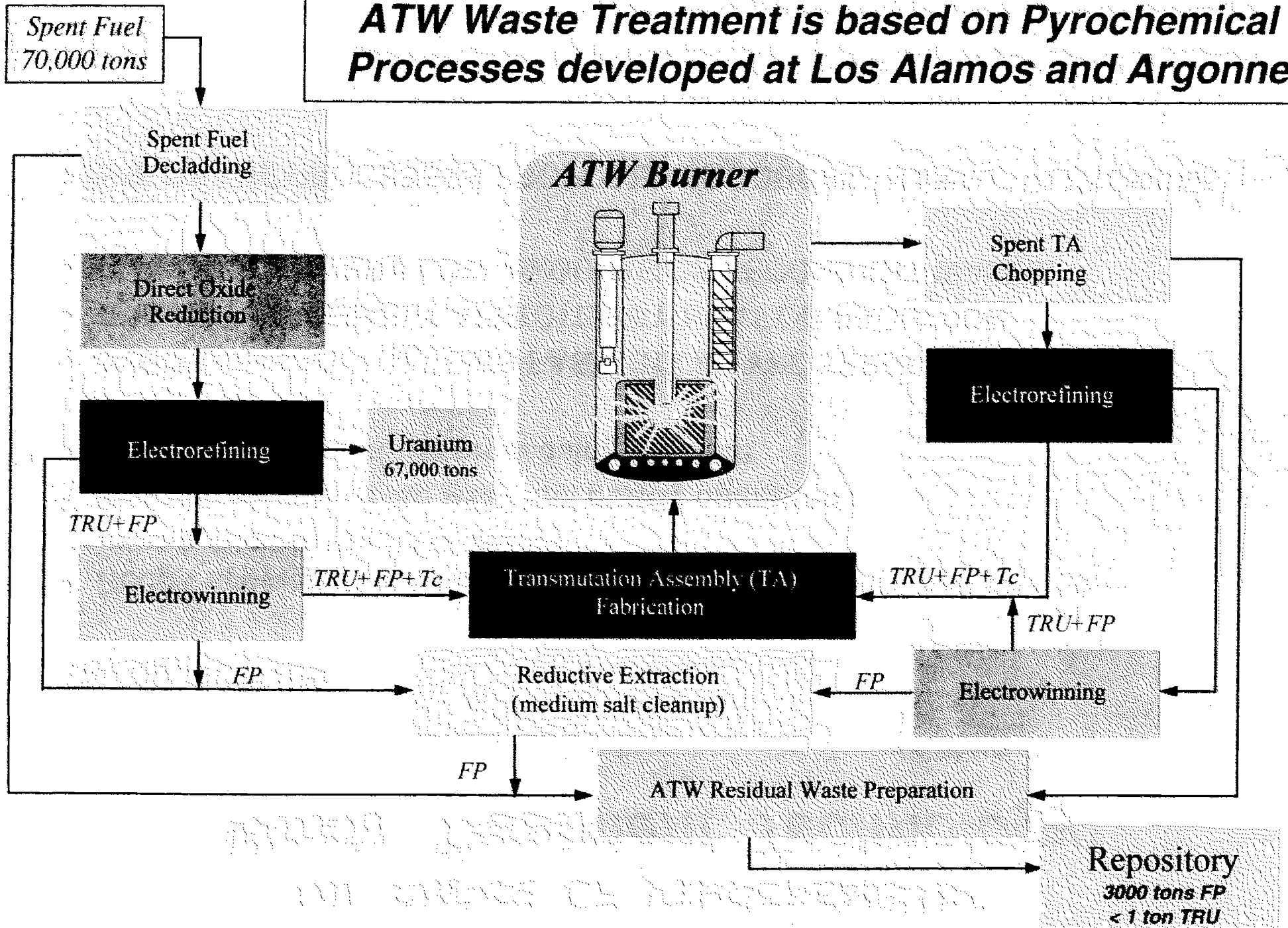

***ATW Waste Forms provide FP partitioning  
for good Repository performance***

<b>Transition Metal Oxides (contain residual TRU)</b>	<b>repository</b>
<b>Rare Earth Oxides</b>	<b>repository</b>
<b>Active Metals in engineered storage</b>	<b>repository</b>
<b>Xenon, Krypton</b>	<b>gas storage</b>
<b>Assemblies, hardware</b>	<b>repository</b>
<b>Uranium</b>	<b>LLW</b>

## ***ATW Design Objectives***

**Subcriticality level:** such that nature of the fuel is unimportant for operation of the system. We have 0.967 as our highest level.

**Power level:** economy of scale important. Maximum allowable beam size important. Proton damage to window might be driver. Windowless designs could play important role. We select 2000 MWt, with a beam drive 20-40 mA at 1 GeV.

**Accelerator:** 40 mA, 1 GeV. Operates at 75 % rated power (ramp 20-40 mA).

**Power density:** high power density means low inventory. Also short cycle length. We select 300 w/cc, 7 kw/ft, 120 day cycle, 3000 kg inventory

**Passive cooling:** 300 MW natural convection capability (15% of rated power)

**Process rates:** these are governed by the power density. 60 day wait, 60 days to process 1/3 of core. Process inventory is 1000 kg TRU.

**Burndown:** 5-year special operation. Objective is EOL inventory < 300 kg.

***A Specific ATW Scenario:***

***Treatment of 70,000 tons  
Spent Fuel Backlog***

# ***ATW Burner Parameters for Scenario***

*Fission Power: 2000 MW<sub>t</sub>*

*Operational TRU Inventory: 3000 + 1000 kg*

*TRU Burn Rate: 650 kg/yr*

*TRU Burn efficiency (Rate/inventory): 16.25%*

*Conversion ratio: 0.0*

*Thermal to electric efficiency : 40%. 800 MWe*

*Recirculated power: 100 MWe (67 to accelerator, 33 to plant operations)*

*Power to Grid: 700 MWe*

*Process losses: 1/1000*

# ATW implementation scenario

Number of ATW units, coming on line, closing down

Time (years)

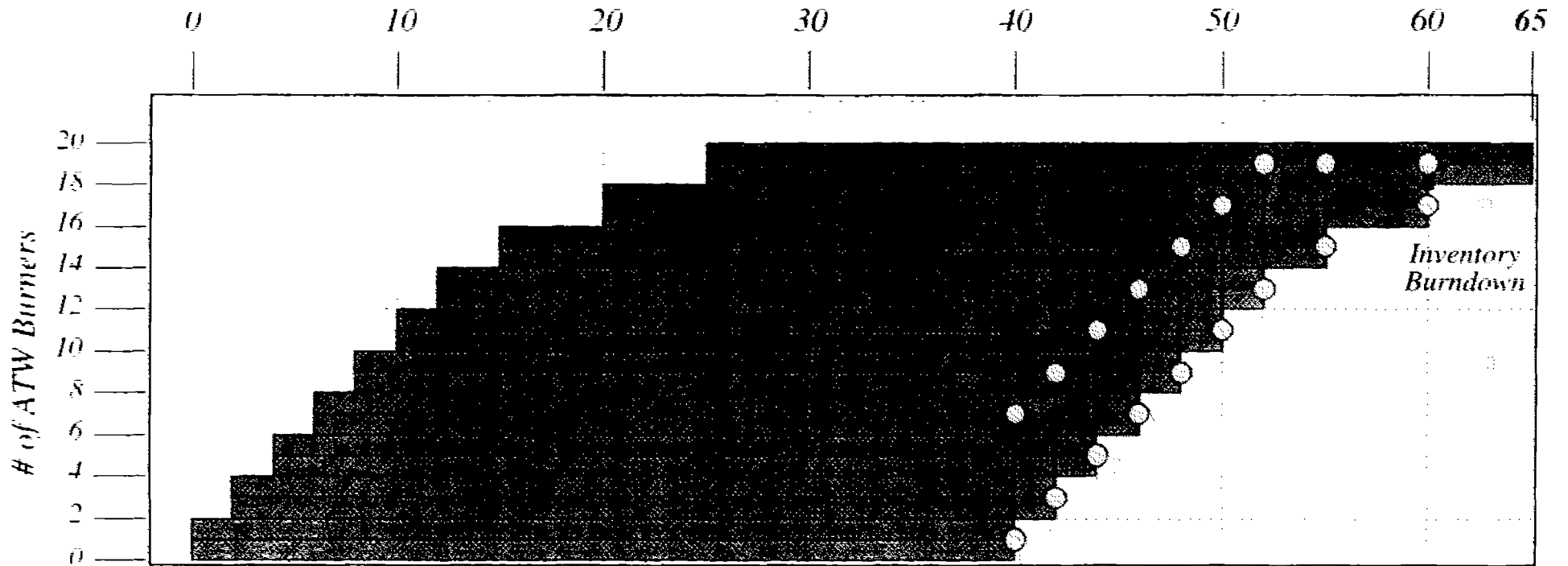

1 ATW burner (40 years operational life, 2000 MWt)





*Large Reduction in Transuranic Inventory  
achieved in time comparable to plant's lifetime*

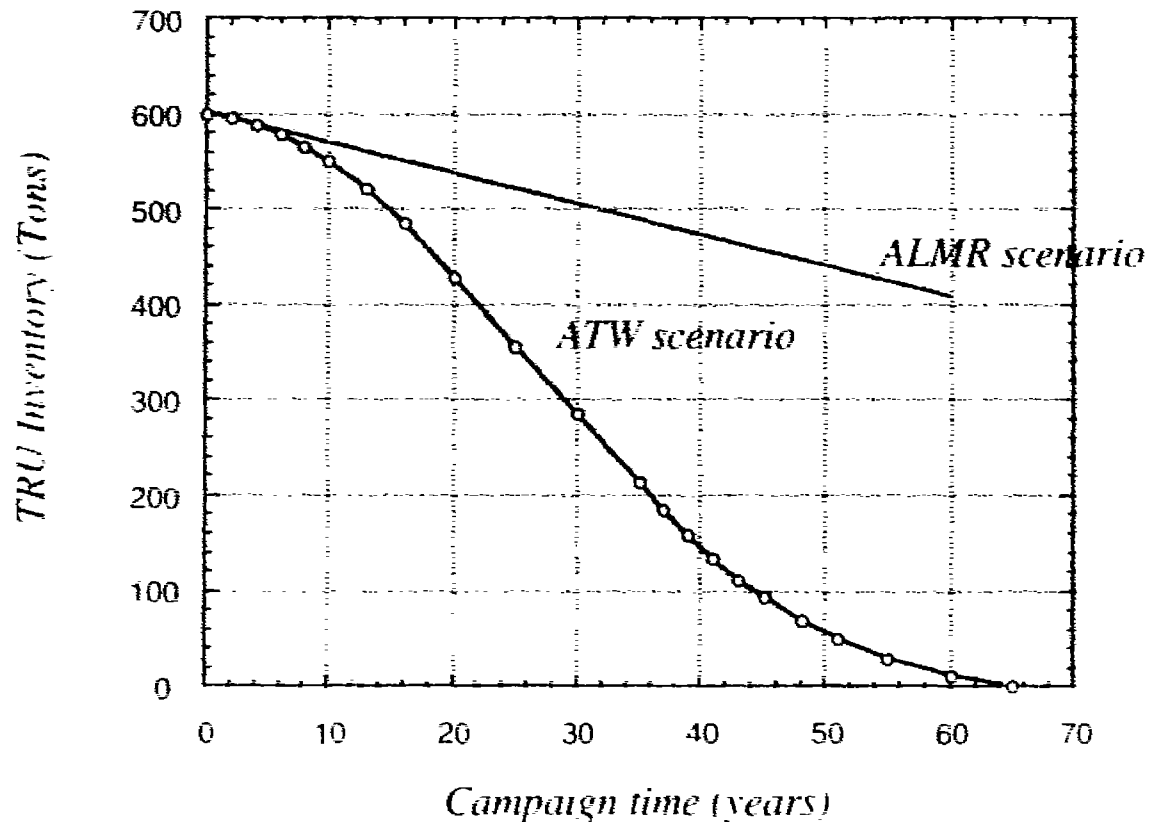

*The key to the vast improvement over the use of ALMRs is the ability to handle pure transuranic cores, without fertile material and to reduce EOL inventory beyond criticality*

## *ATW implementation scenario*

$\Psi$  = Pigford-Choi TRU reduction factor = TRU in original waste / current TRU inventory

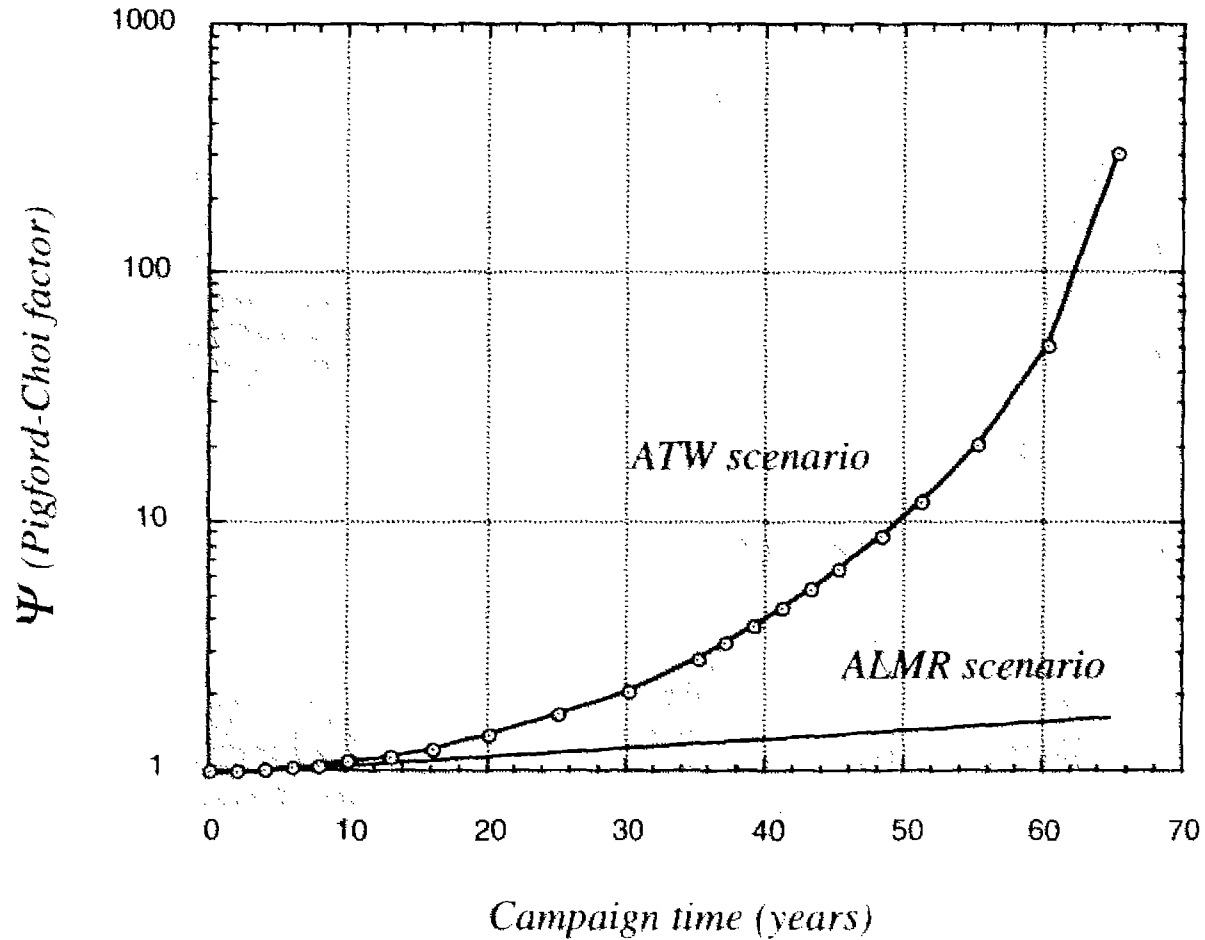

## ***Rough Costs for Scenario***

### *Baseline Assumptions:*

<b>CAPITAL COST</b>			
<b>Component</b>	<b>Unit cost (\$M)</b>	<b>Quantity</b>	<b>Total Cost (\$M)</b>
Waste Treatment	\$1,000	1	\$1,000
Cleanup Facility	\$500	1	\$500
Accelerators	\$500	20	\$10,000
Subcritical Burner	\$750	20	\$15,000
Power Conversion & Distribution	\$750	20	\$15,000
<b>TOTAL CAPITAL CHARGE ==&gt;</b>			<b>\$41,500</b>
O&M	\$1,245	1	\$1,245
<b>Electric Sales</b>			
Thermal power per burner (MW)	2,000	20	40,000
conversion ratio		40%	
Electric power MWe - gross			16,000
Unit power per accel installation	100	20	2000
<b>Net power for sale ==&gt; (MWe)</b>			<b>14,000</b>
<b>Cost of electricity (mits/kWe-hr) ==&gt;</b>			<b>30</b>
<b>Plant availability ==&gt;</b>			<b>75%</b>
<b>Annual revenue from Electric Sale ==&gt; (\$M)</b>			<b>\$2,761</b>
<b>Net annual revenue for ATW option ==&gt;</b>			<b>\$1,516</b>

# Rough Costs for Scenario

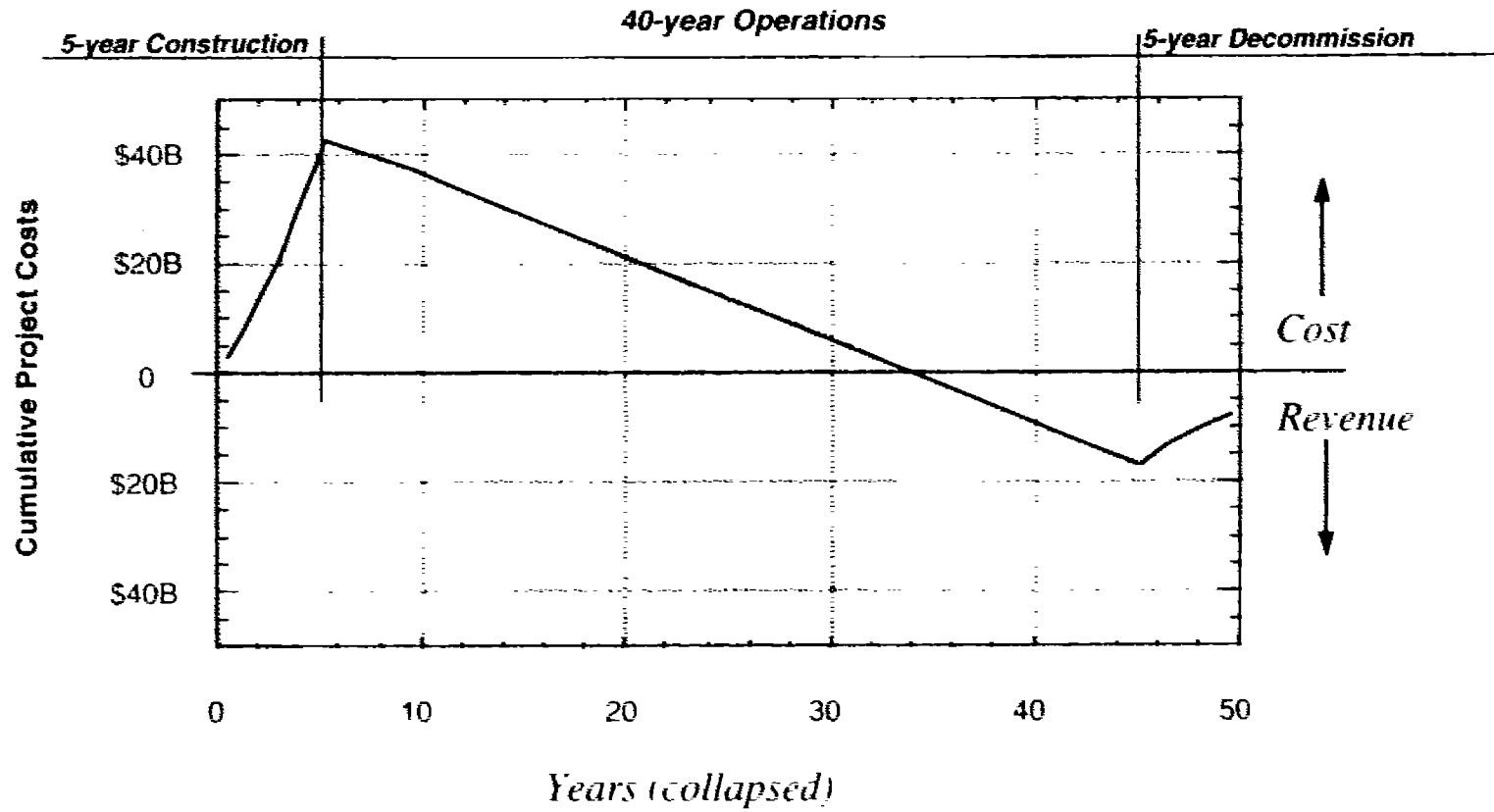

*ATW waste destruction could provide economic benefits*

# ATW Balance

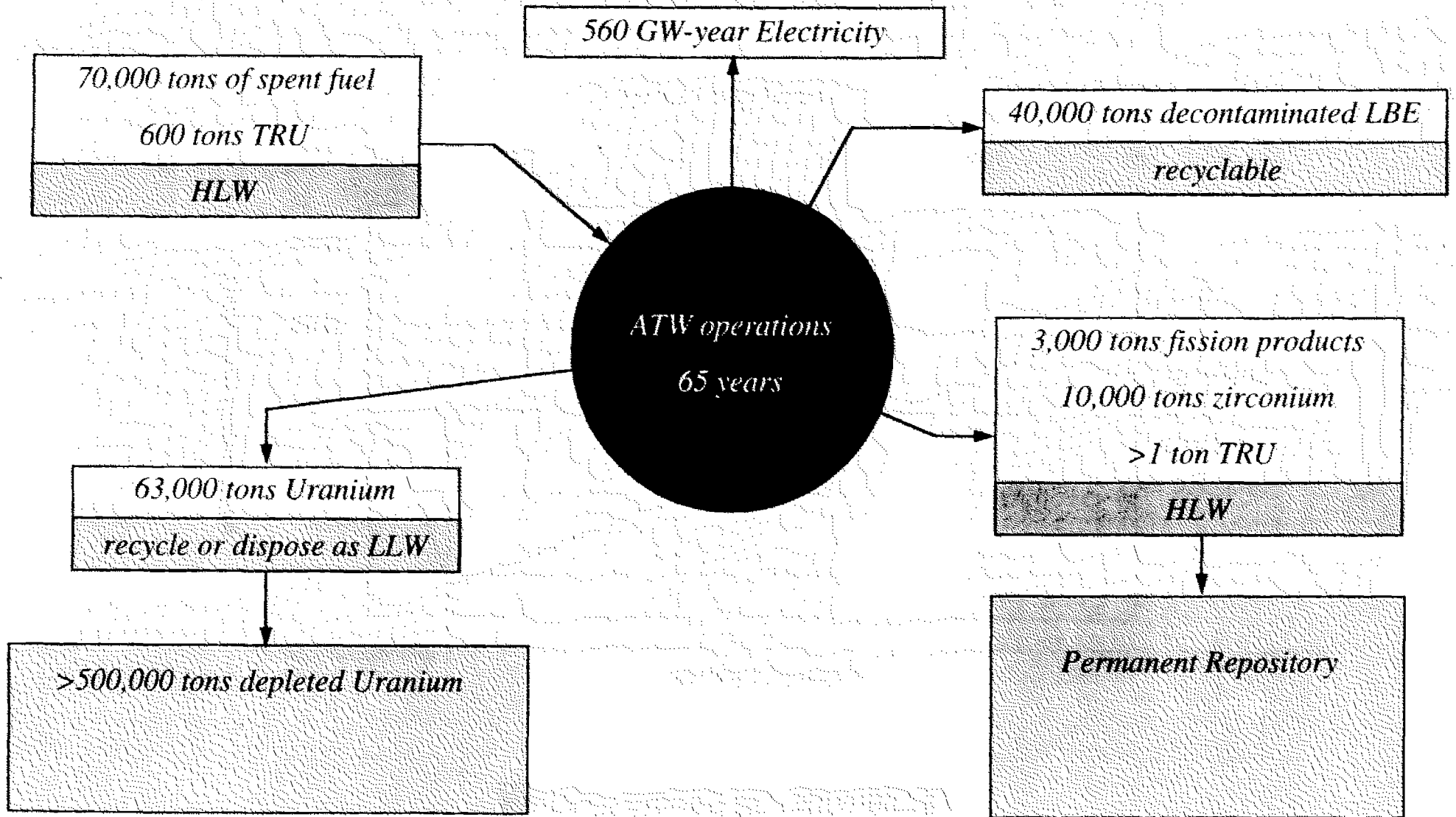

	ALMR* (2000-MWt parks) each park is 4 modules	ATW (2000-MWt units)
TRU initial	600 tons	600 tons
TRU inventory (per unit or park, <u>Core+ Process</u> )	7720 + 5150 = 12,870 kg	3000 + 1000 = 4000 kg
Breeding Ratio	0.76	0.0
TRU destruction rate (75% avail.)	130 kg/yr	650 kg/yr
TRU destruction ratio (rate/inventory)	1.01 %/yr	16.25 %/yr **
Decontamination Factor	1000	1000
<b>Campaign time</b>	<b>~ <u>320 yrs</u> (<math>\Psi &gt; 15</math>)</b>	<b>~ <u>65 yr</u> (<math>\Psi &gt; 200</math>)</b>
<b># required (ALMR parks or ATW units)</b>	<b>33+24+17+12+9+... = <u>110</u>***</b>	<b><u>20</u>***</b>
waste to repository	5500 tons	3000 tons
total electricity produced (40% eff.)	~ 40.E+12 kw-hr	~ 4.0E+12 kw-hr
residual TRU inventory	~ 39 tons	< 1 ton

$\Psi$  = Pigford-Choi factor = TRU in original waste / current TRU inventory

\* from STATS panel report

\*\* >50% during burn-down phase

\*\*\* 40-year plant life

# ***Other Scenarios***

# ATW can be efficiently deployed to complement many different fuel cycles and waste management scenarios

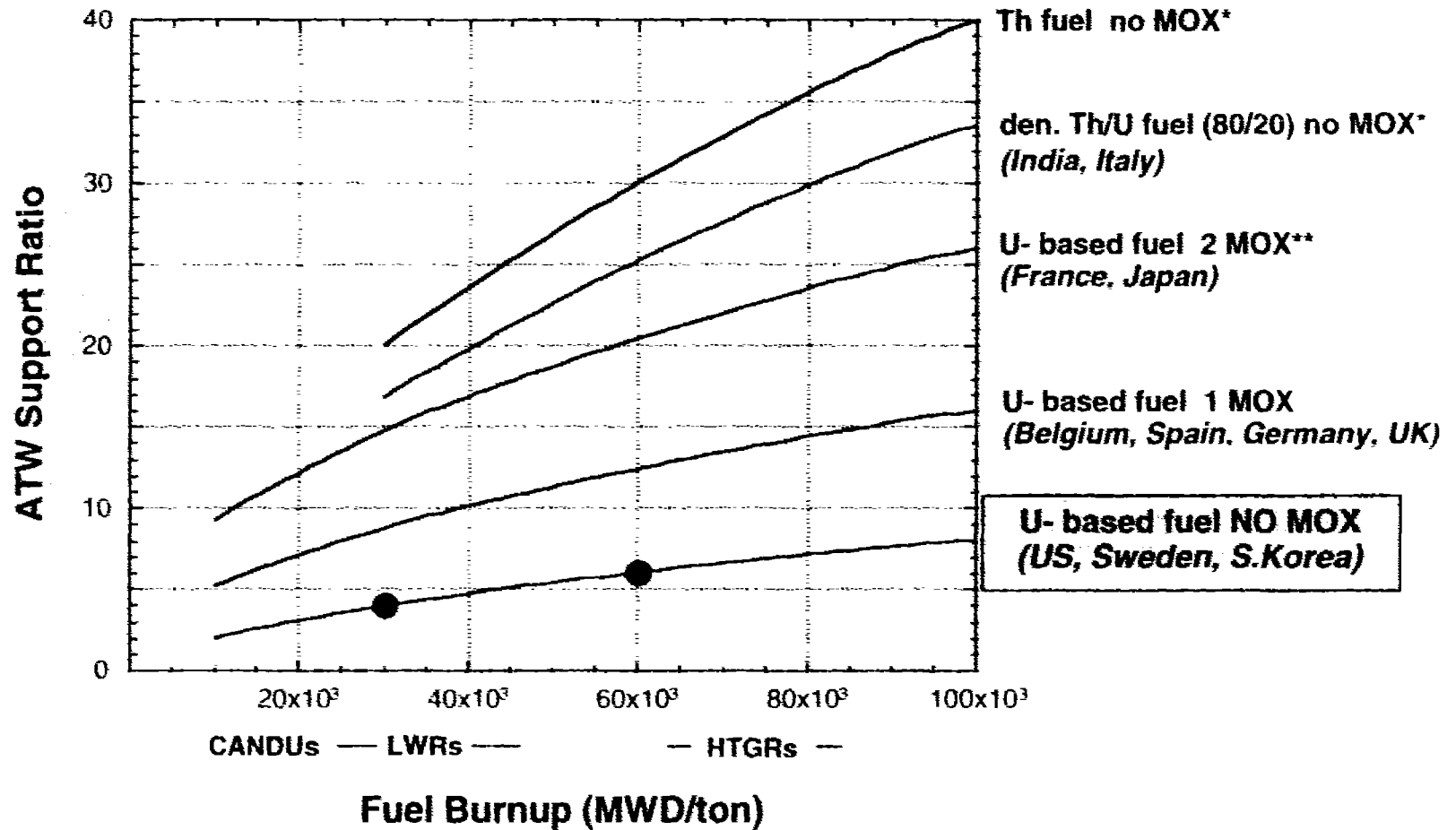

**ATW Support Ratio** = the number of reactors whose actinide waste is destroyed by one ATW system of the same thermal power

\* large fraction of <sup>238</sup>Pu  
 \*\* large fraction of minor actinides



# ***What You Should Remember About ATW***

- It is a ***Nuclear Waste Management enhancing*** technology
- Addresses issues of repository storage capacity and the longevity of radiological hazards:
  - *destruction of all transuranics*
  - *transmutation of Tc-99 and I-129, other isotopes if required*
  - *partition of all other fission products for optimal disposal*
  - *radiotoxicity of ATW waste after 300 years is lower than direct-disposal waste after 100,000 years*
- It is reactor-like in scale and function. Produces usable energy by destroying nuclear waste
- Its components are based on proven technology, can be directly transferred to nuclear power production
- Although spent fuel is processed, weapons-usable material is not made available
- It is adaptable to different fuel cycles
- In the mission of waste destruction, it is significantly faster and more complete than the other S+T schemes

# ATW Development Road Map

where we are, 1998:

## Technology Assessment

- *Accelerator technology*  
status: APT-driven, ATW specific features could be developed from APT
- *Liquid lead technology*  
status: early stage in US, Russian technology fully developed
- *Pyrochemistry*  
status: individual parts well developed, Argonne and LANL have expertise

## 5-year Development Plan

### Technology Verification and Small-scale Integration

- *Nuclear design (including Safety)*
- *Integrated small scale waste processing plant*
- *Fuel development*
- *Russian liquid lead technology transfer*
- *High power spallation targets*
- *Materials verification*
- *ATW-specific accelerator design*
- *Systems studies*

where we are going:

### Large scale Integration and Implementation

**ATW Subcritical Testbed Facility (STF) at LANL**  
**10-50 MW thermal power**

**ATW Process Facility (APF)**  
**>100 kg scale**

**DEMONSTRATION of Accelerator-driven Waste Transmutation system**

**10-20 MW beam**  
**500-1000 MWth**

1999

2004

# ATW Consists of Three Major Functional Blocks

## Accelerator

APT  
Technology

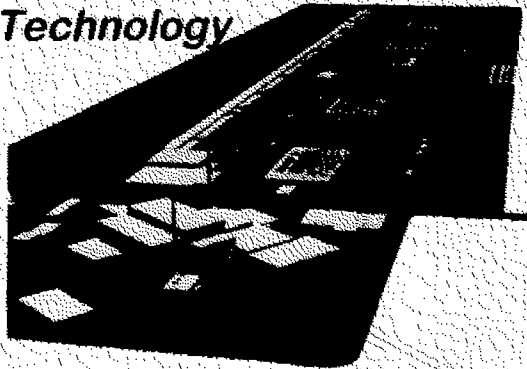

## Pyrochemical Processes

Proliferation  
resistant, low  
environmental  
impact

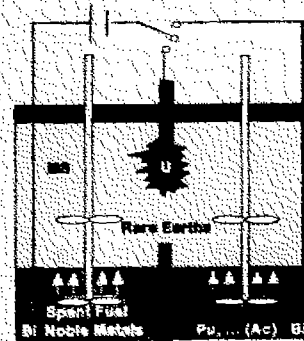

## Spent Fuel

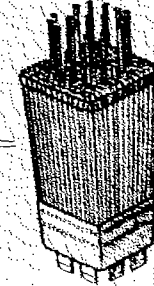

## Subcritical Burner (multiple units)

Liquid Lead  
Nuclear  
Technology

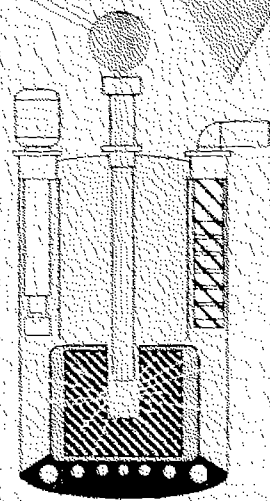

## Power Production

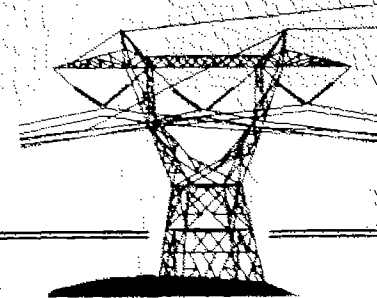

## Residual Waste to Repository

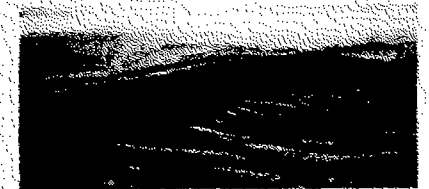

Power to Grid:  
~ 90%

Power to Accelerator: ~10%

## ***ATW Design Objectives***

**Subcriticality level:** such that nature of the fuel is unimportant for operation of the system. We have 0.967 as our highest level.

**Power level:** economy of scale important. Maximum allowable beam size important. Proton damage to window might be driver. Windowless designs could play important role. We select 2000 MWt, with a beam drive 20-40 mA at 1 GeV.

**Accelerator:** 40 mA, 1 GeV. Operates at 75 % rated power (ramp 20-40 mA).

**Power density:** high power density means low inventory. Also short cycle length. We select 300 w/cc, 7 kw/ft, 120 day cycle, 3000 kg inventory

**Passive cooling:** 300 MW natural convection capability (15% of rated power)

**Process rates:** these are governed by the power density. 60 day wait, 60 days to process 1/3 of core. Process inventory is 1000 kg TRU.

**Burndown:** 5-year special operation. Objective is EOL inventory < 300 kg.

Many engineering, technological and safety problems of ATW are common to reactors. Russian experience will be very valuable in development of design.

## Engineering Variants

Coolant Type	Pb-Bi	Pb
Target design	Windowed	Windowless
Target cooling system	Separate circuit	Same as blanket cooling system
Number of circuits	2	3
Coolant circulation	Forced circulation	Natural convection
Fuel type	Oxides	Metal
Fuel rod type & fuel assembly design	Spacing by rib wrap	Spacer grid

### Safety Considerations

Freezing/defreezing coolant technology  
Steam generator tube rupture

PO decontamination  
Oxygen level control

Loss of heat sink accident  
Loss of coolant circulation

# Minimized-RISK APPROACH for ATW DEVELOPMENT

	Beam Power	Fission Power	Power Density	Fuel Type	Neutron Flux	Chemistry
<b>LANL-IPPE Target (1999 - 2001)</b> <i>no fissionable material. Competency development. High radiation environ. Window testing, TH stressed</i>	1 MW	---	500 w/cc	---	$>10^{**13}$	Oxygen control
<b>Subcritical testbed (2001-2010)</b> <i>Limited fissionable inventory. Could use LANSCE. TRU fuel development + test.</i>	1-2 MW	10-50 MW 0.75-0.9 keff	100 w/cc	UO <sub>2</sub> (20% enr.) metal fuel test	$>10^{**14}$	Po removal Oxygen control
<b>ATW demonstration (2007 - )</b> <i>Conservative approach. Forgiving Operation. Could be at SRS/APT. Chemistry, FP transmutation., full TH</i>	10 - 20 MW	500-1000 MW 0.95 keff	100 w/cc	metal fuel U - TRU core	$>10^{**15}$	fully integrated waste treatment +transmutation
<b>ATW full size burner (2015 - )</b> <i>Full TRU destruction performance. Accelerator load following, extend. burn.</i>	20 - 40 MW	2000 MW 0.97-0.93 keff	350 w/cc	metal fuel full TRU core	$>10^{**15}$	fully integrated waste treatment +transmutation

# SUBCRITICAL REACTOR CONCEPTUAL CHARACTERIZATION

---

## THE ATW DEMONSTRATION PLANT

Mario D. Carelli, Tom J. Fagan, Larry Green,  
Dmitry V. Paramonov, and Wayne L. Chase  
*Westinghouse Science & Technology Center*

M. Houts

*Los Alamos National Laboratory*

A presentation to MIT, Nuclear Engineering Department

January 15-16, 1998



Westinghouse  
Science & Technology Center

# OUTLINE

---

- **Approach**
- **Point Design**
- **Preliminary Performance Calculations**
- **Future Effort**



# **HEAVY METAL (LEAD BISMUTH EUTECTIC) COOLED REACTOR**

---

- **Transfer Soviet technology (Alpha class submarines)**
- **No need for separate target**
- **Potentially safer than either water or alkali metal cooled reactors**
  - **Very high boiling point**
  - **No pressurization needed**
  - **No violent reaction with air or water**
  - **Self-plugging leaks (melting point higher than room temperature)**
  - **Natural circulation potential under normal operation**
  - **Can be designed to be passively safe**

# APPROACH

---

- **Minimize development**
  - **Russian cooperation**
  - **Utilize water and sodium reactors experience**
- **Safety/design conservatism has precedence over economic performance for demo**
- **Outline potential improvements for future designs**

# WHY A DEMO

---

- **Demonstrates new technology**
- **Identifies development needs**
- **Easily scaleable to prototype**
- **Design and operation experience**
- **Provides realistic test bed**

# DESIGN CHOICES

---

- **Pool configuration**
  - **LMR experience**
  - **Safety**
- **Intermediate heat exchanger (IHX)**
  - **Polonium and other radioisotopes containment**

## **Nuclear steam turbine**

- **LWR experience**
- **More compact IHX and steam generator**
- **Margin for upgrading**



# ATW REACTOR SCHEMATIC

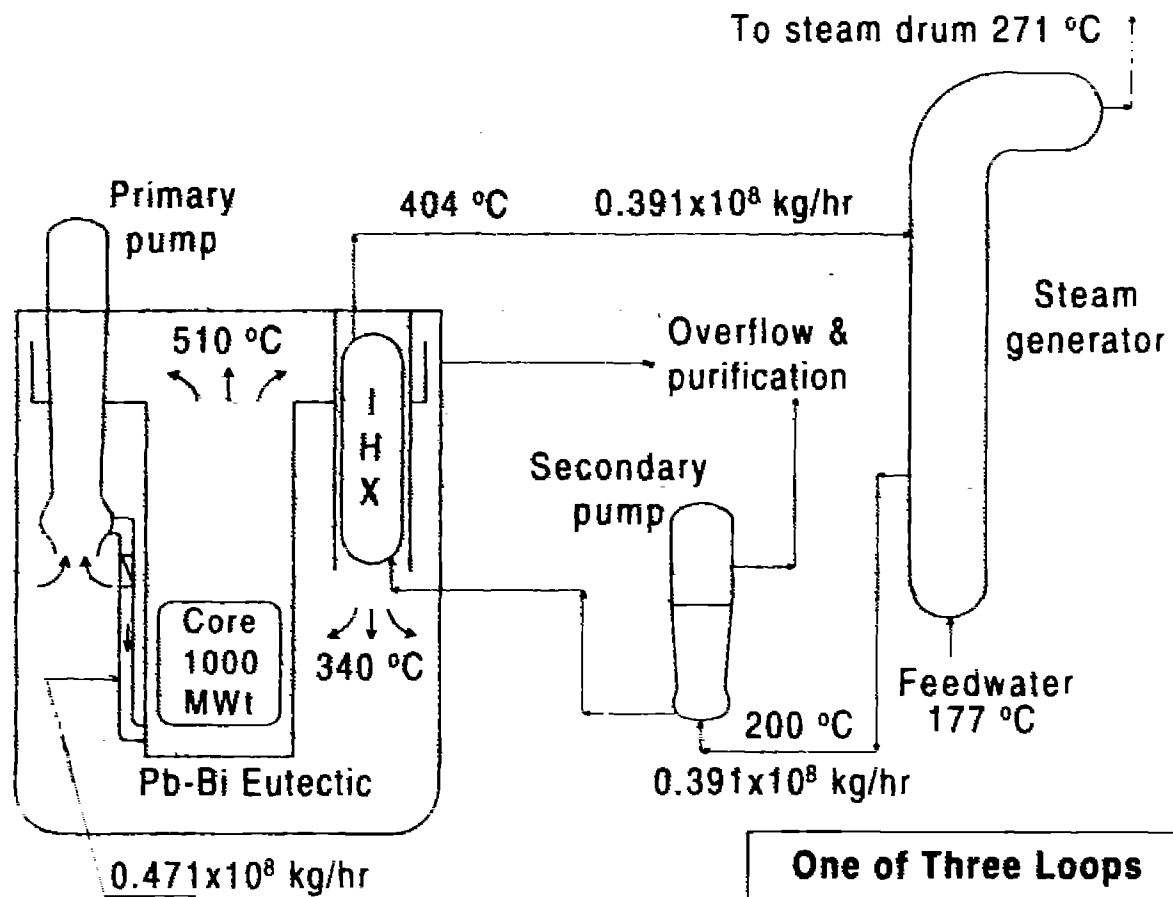

## DESIGN CHOICES (Cont'd.)

---

- **Hexagonal canned assemblies**
  - LMR experience
  - Orificing to offset radial power distribution
  - VVER and thermal breeder experience for triangular pitch grids
- **1000 MWt reactor design**
- **Core inlet/outlet temperatures 340/510°C**
  - Same as Russian design
- **“Diluted” core**
  - Enhance natural circulation
  - Moderate power density

# VVER (TEMELIN) FUEL ASSEMBLY (ATW ASSEMBLY HAS 91 PINS)

---

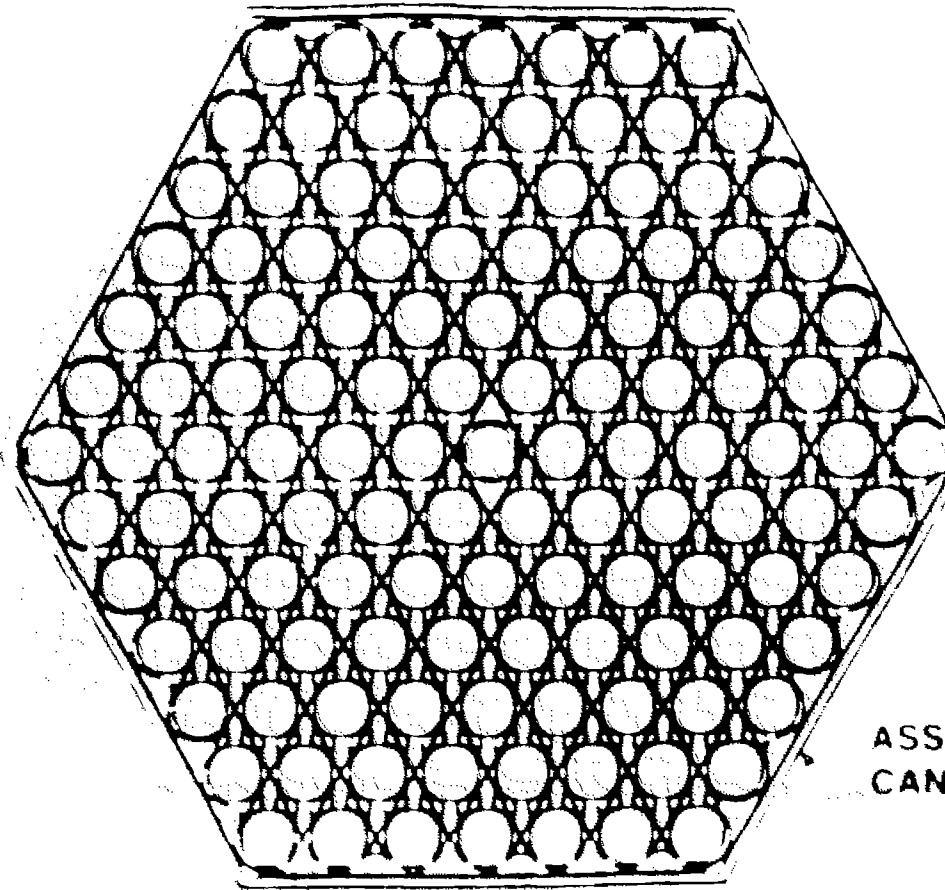

ASSEMBLY  
CAN



# ATW REACTOR SCHEMATIC

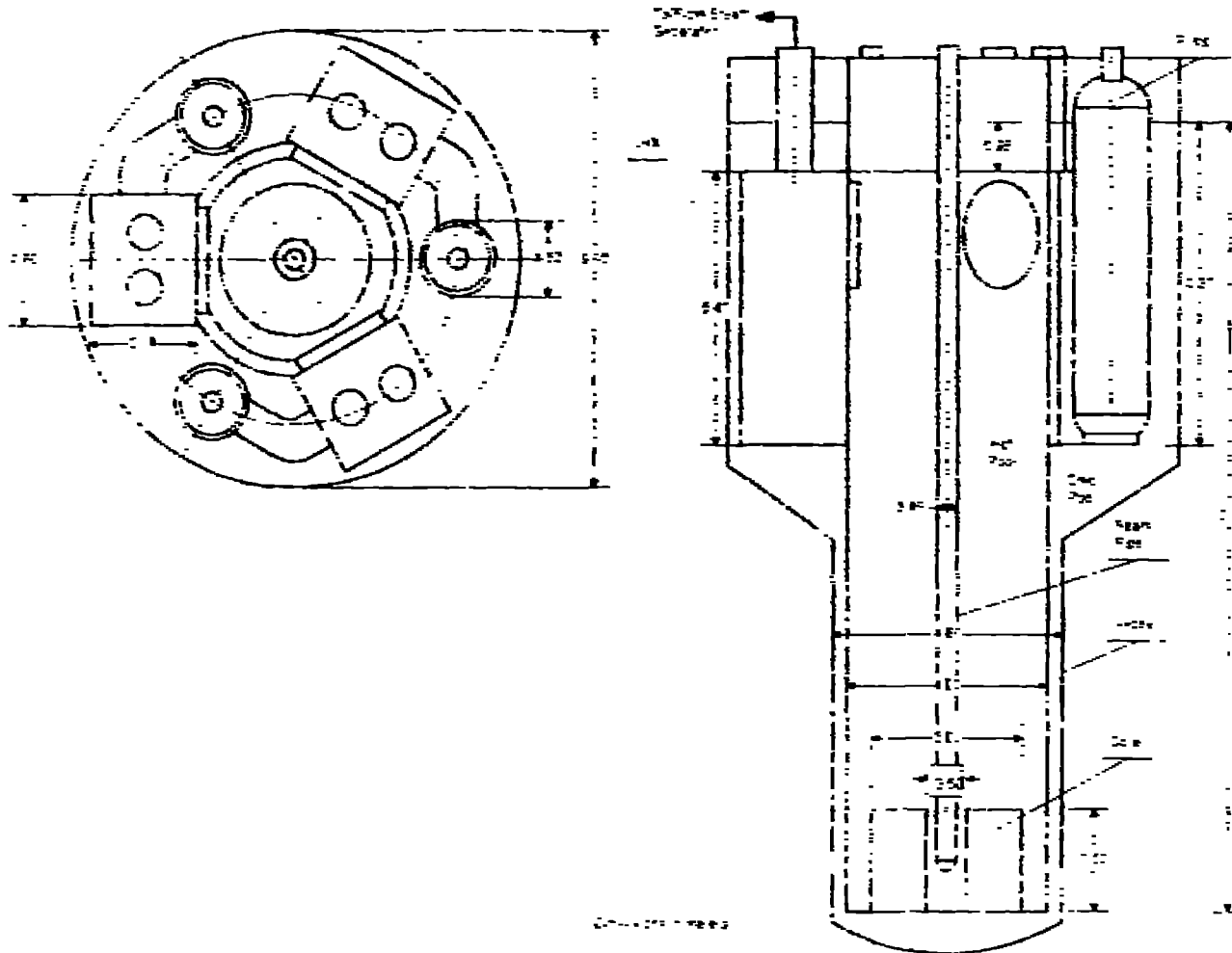



# COMPARISON OF COOLANTS FOR NATURAL CIRCULATION

Coolant	Reactor	T <sub>in</sub> /T <sub>out</sub> (°C)	Driving Head ( $\Delta\rho$ )		Heat Capacity ( $\rho c_p$ )		Margin to Boiling (T <sub>boil</sub> -T <sub>out</sub> )	
			g/cm <sup>3</sup>	normalized	J/m <sup>3</sup> K 10 <sup>6</sup>	normalized	°C	normalized
Pb-Bi eutectic	ATW	340/510	0.205	1	1.53	1	1160	1
Pb	BREST	420/540	0.146	0.71	1.50	0.98	1185	1.02
Na	CRBR	388/535	0.036	0.18	1.08	0.71	350	0.30
H <sub>2</sub> O	4 loop PWR	283/325	0.073	0.36	2.93	1.91	18	0.02



# CORE GEOMETRY

---

<b>Outer diameter</b>		<b>3 m</b>
<b>Inner diameter</b>		<b>0.8 m</b>
<b>Height</b>		<b>2 m</b>
<b>Hexagonal assemblies, triangular pitch</b>		
<b># assemblies</b>		<b>416</b>
<b># pins/assembly</b>		<b>91</b>
<b>Pin diameter</b>		<b>0.8382 cm</b>
<b>p/d</b>	<b>1.69</b>	
<b>Cladding thickness</b>		<b>0.46 mm</b>
<b>Pellet diameter</b>		<b>0.7068 cm</b>
<b>Gap (metal bond)*</b>		<b>0.2 mm</b>
<b>Can flat-to-flat</b>		<b>13.5 cm</b>
<b>Can thickness</b>		<b>3 mm</b>

**\*He gap alternative is considered**



*Core Map for 1000 MWt  
ATW DEMO*

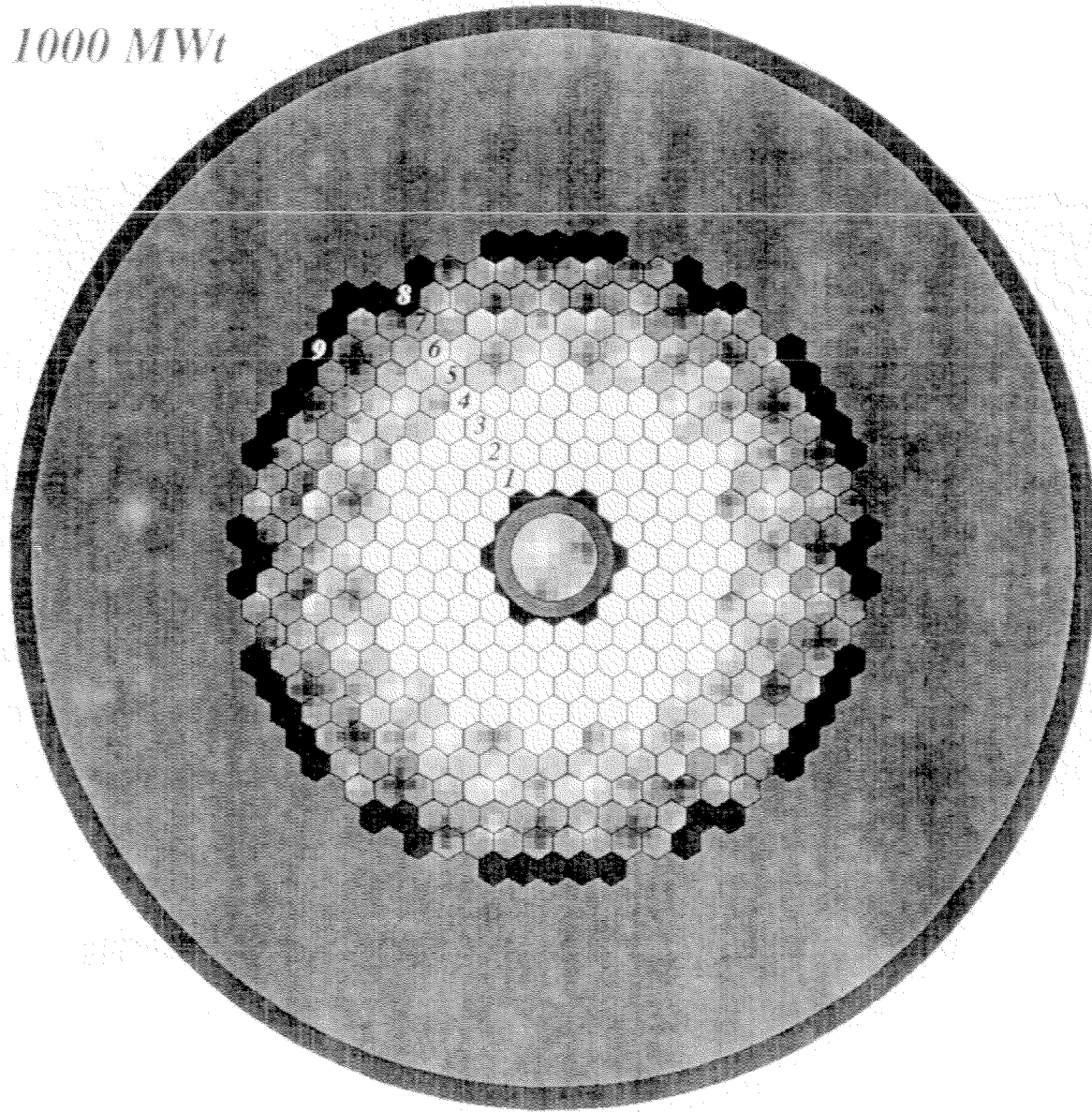

300 cm

# Steady-State Demo-ATW Radial Power Profile

Relative Power Density vs Radial Position (cm)

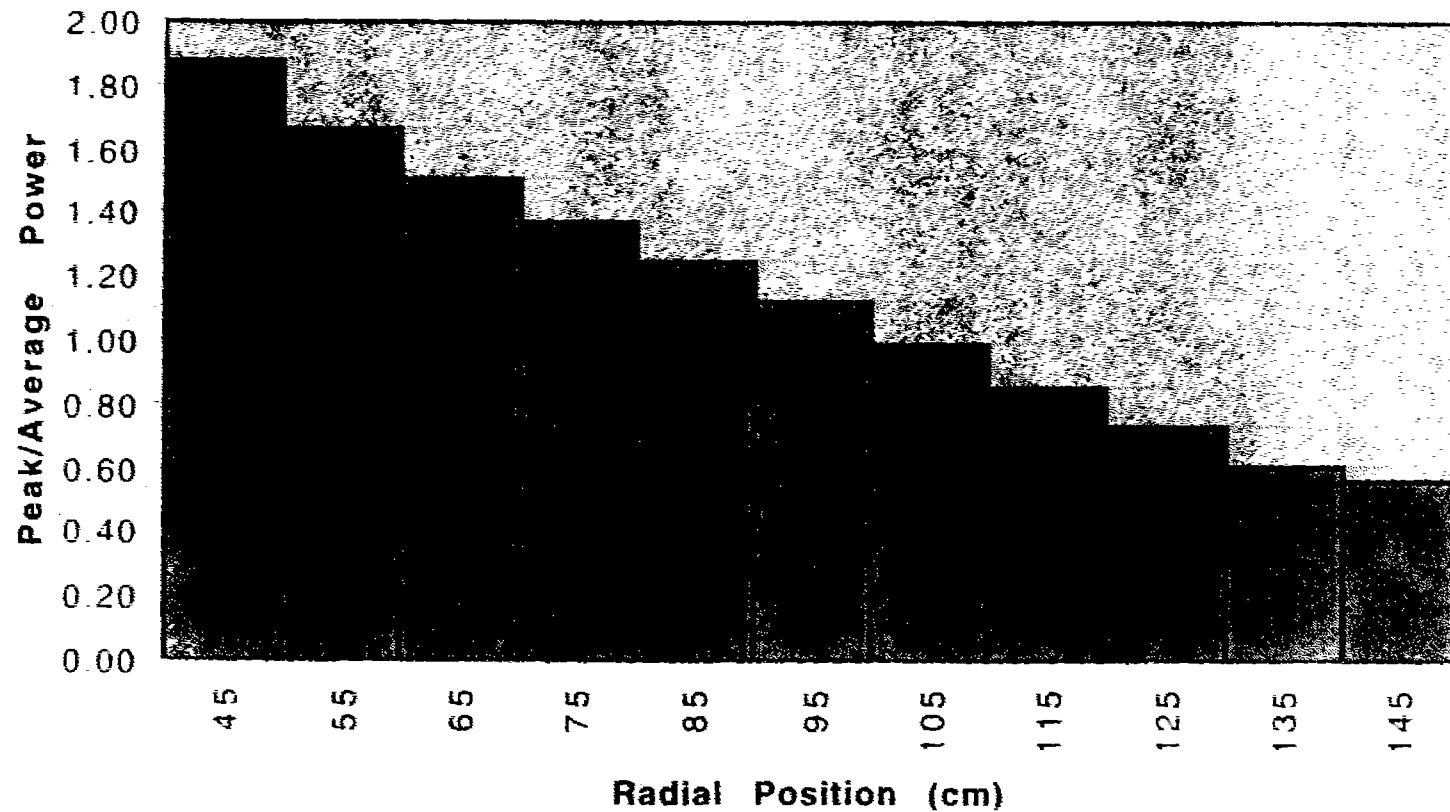

# Steady-State Demo-ATW Axial Power Profile

Relative Power Density Vs Axial Position (cm)

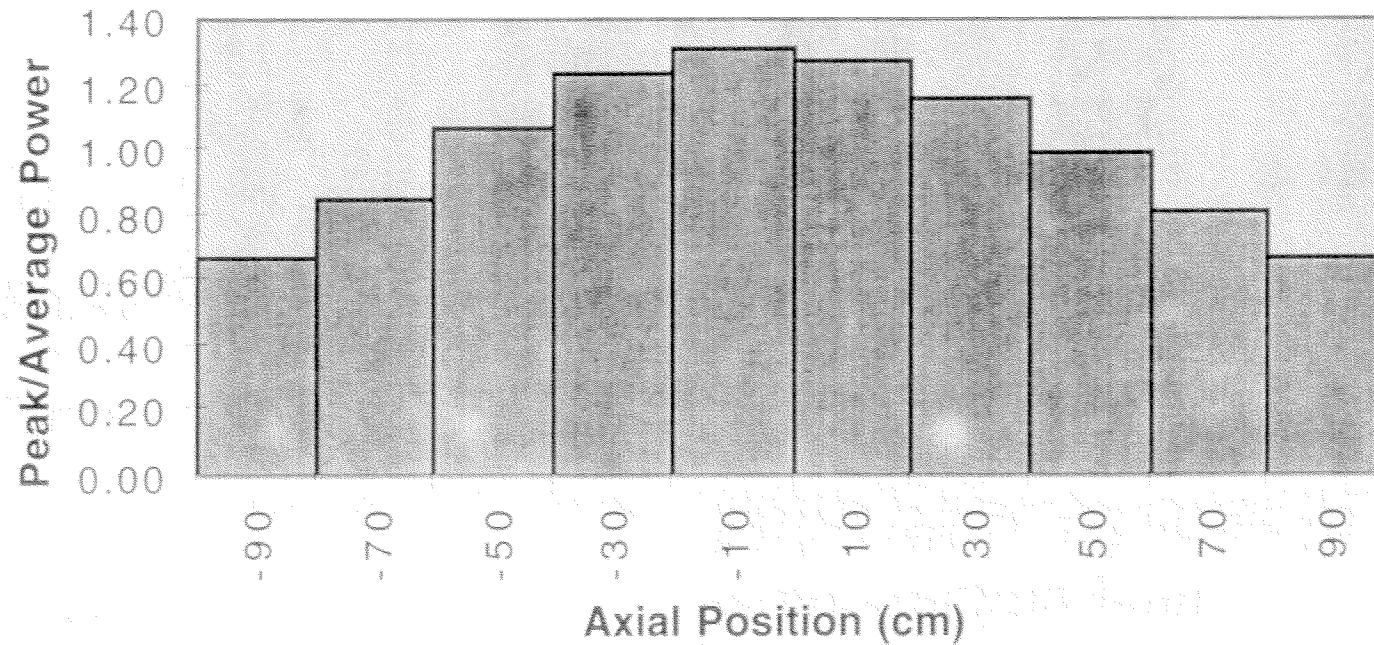

# PRELIMINARY LIMITING TEMPERATURES

---

<b>Coolant</b>	<b>None (boiling point is higher than all other limits)</b>
<b>Vessel</b>	<b>700°C (Russian data)</b>
<b>Cladding</b>	<b>800°C (Russian data)</b>
<b>Fuel</b>	<b>1200°C (LANL, Zr matrix)</b>



# PRELIMINARY UNCERTAINTY FACTORS

---

<b>Enthalpy Rise</b>	<b>1.8</b>
<b>Film <math>\Delta T</math></b>	<b>2.0</b>
<b>Cladding <math>\Delta T</math></b>	<b>1.5</b>
<b>Gap <math>\Delta T</math></b>	<b>2.0</b>
<b>Fuel <math>\Delta T</math></b>	<b>2.0</b>
<b>Radial peaking factor not compensated by orificing</b>	<b>1.1</b>



# PIN RADIAL TEMPERATURE PROFILE

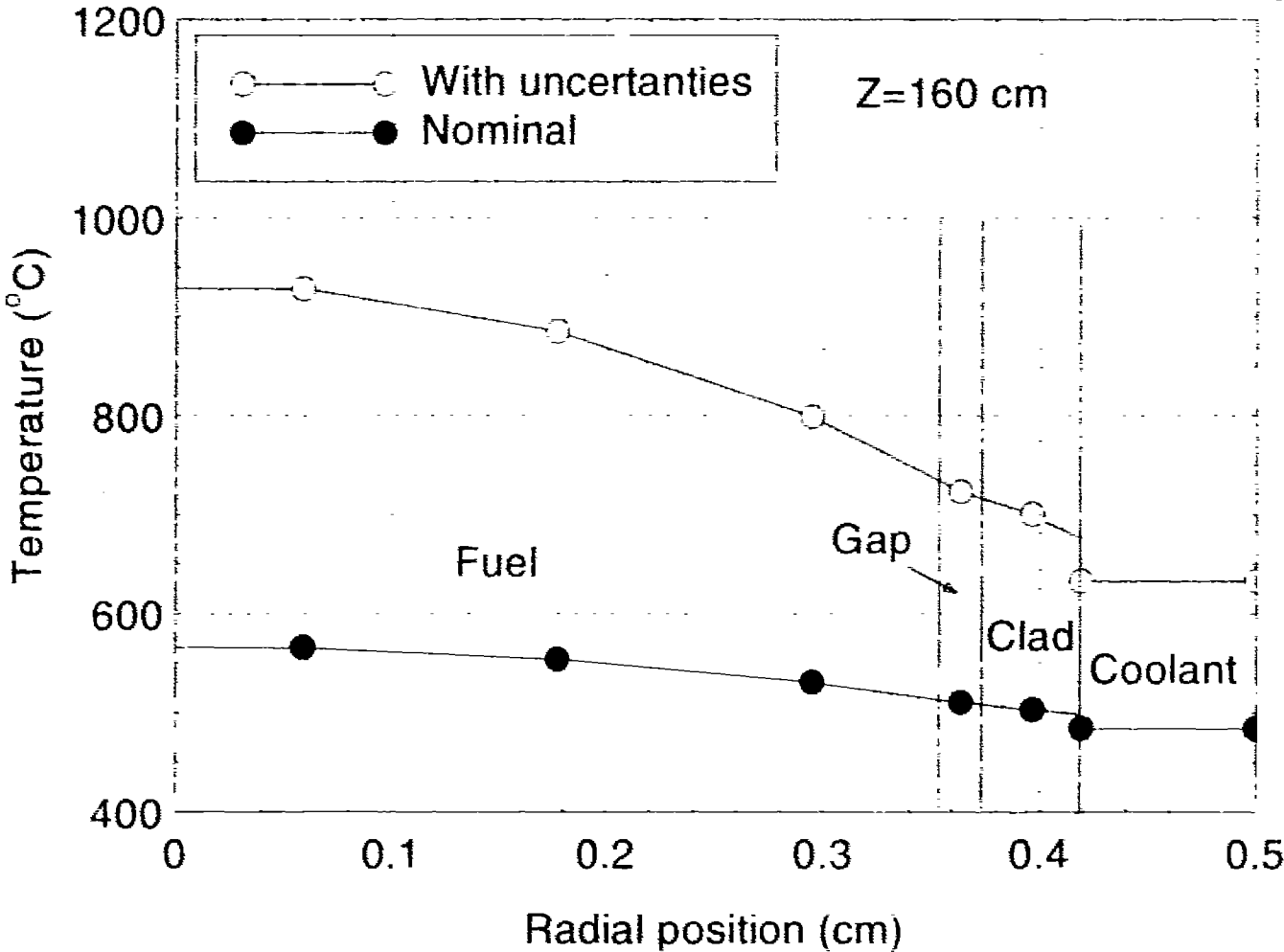



# HELIUM GAP TEMPERATURE DROP (NOMINAL)

---

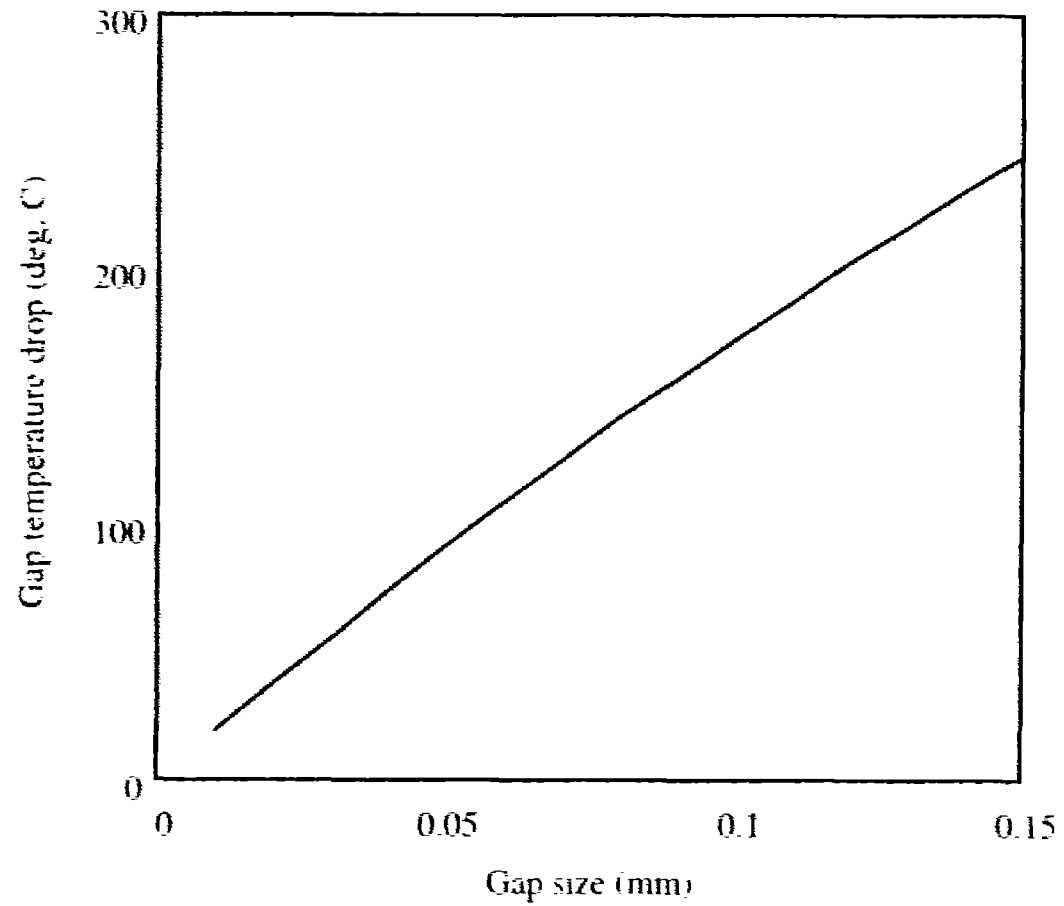

# INTERMEDIATE HEAT EXCHANGER

- 2 halves of 60 x 70 rows - 4200 tubes (2.23 cm diameter x 2.14 m length) each on a triangular pitch -  $P/D = 1.5$
- Overall dimensions: 2.58 x 2.14 x 5.22 m
- H-27 steel (3 Cr, 0.8 Mo)
- Primary fluid (outside tubes) velocity = 0.463 m/s,  $\Delta P = 3.6$  psi
- Secondary fluid (inside tubes) velocity = 0.921 m/s,  $\Delta P = 5.9$  psi

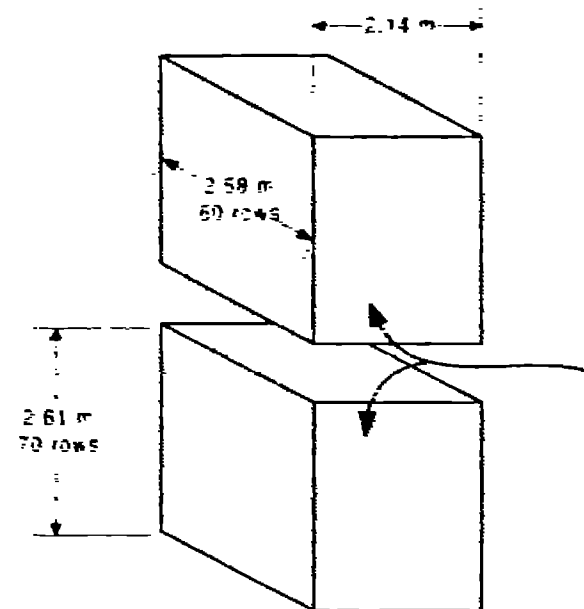

# PRIMARY SYSTEM HYDRAULICS SUMMARY

Parameter	Pumps On	Pumps Off
Core Exit Temperature (°C)	510	631
Core Temperature Rise (°C)	170	295
Mass Flow Rate (kg/sec)	$3.96 \times 10^4$	$2.32 \times 10^4$
Core Pressure Drop (psi)	5.0	1.9
Core Flow Velocity (m/s)	0.79	0.47
IHX Pressure Drop (psi)	3.6	1.3
IHX Flow Velocity (m/s)	1.0	0.6
Piping Pressure Drop (psi)*	4.6	1.7
Pump Pressure Drop (psi)	-	1.0
Total Pressure Drop (psi)	13.2	5.9
Convection Head / Total Pressure Loss	0.25	1.0
Pumping Power (MWe)	0.73	-

\* Conservatively estimated at ~50% of total calculated value for core and IHX



# PUMP FAILURE ACCIDENT - ESTABLISHMENT OF NATURAL CIRCULATION

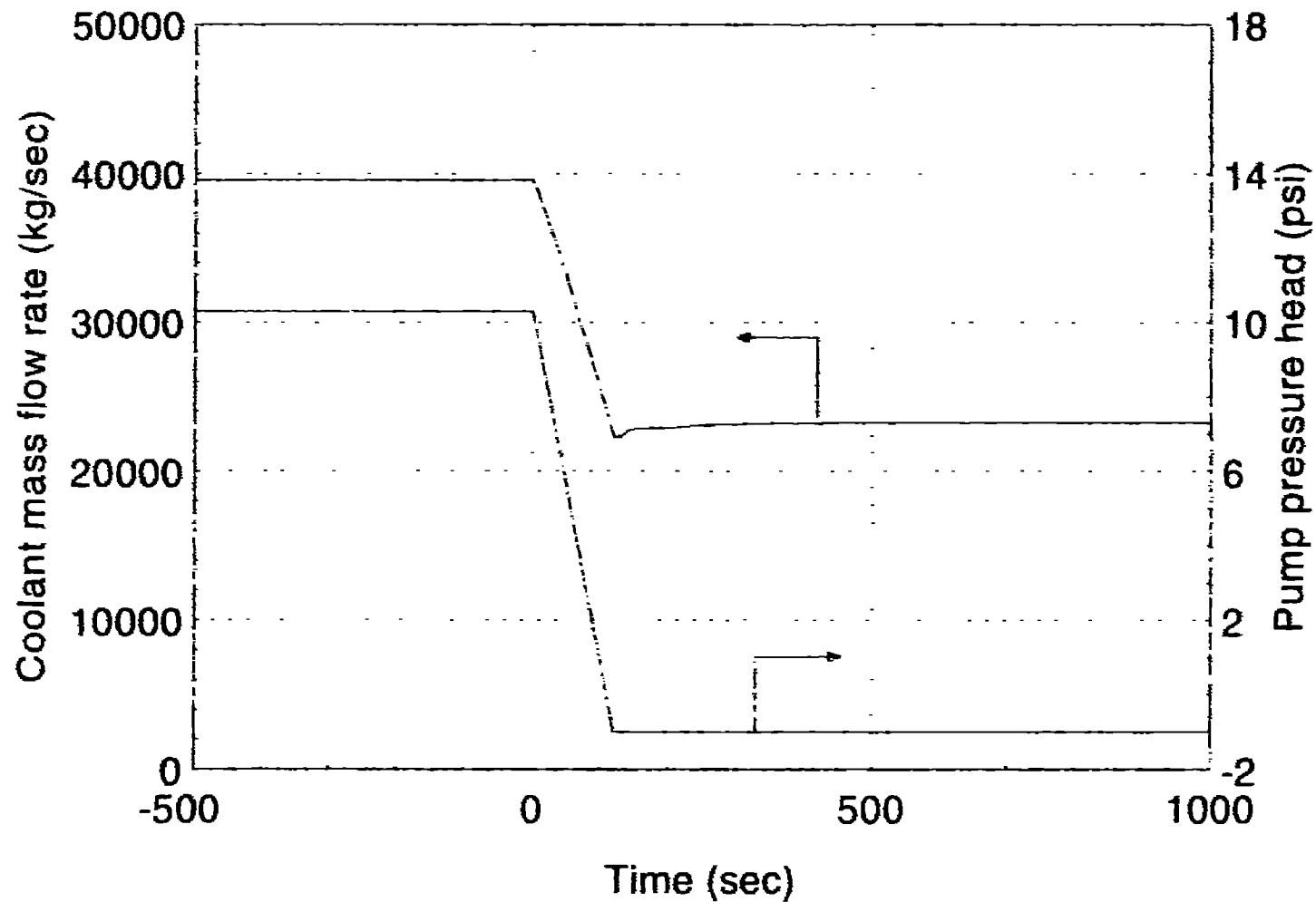

# BEAM ON, PUMPS OFF ACCIDENT - TRANSIENT THERMAL RESPONSE (NOMINAL CONDITIONS)

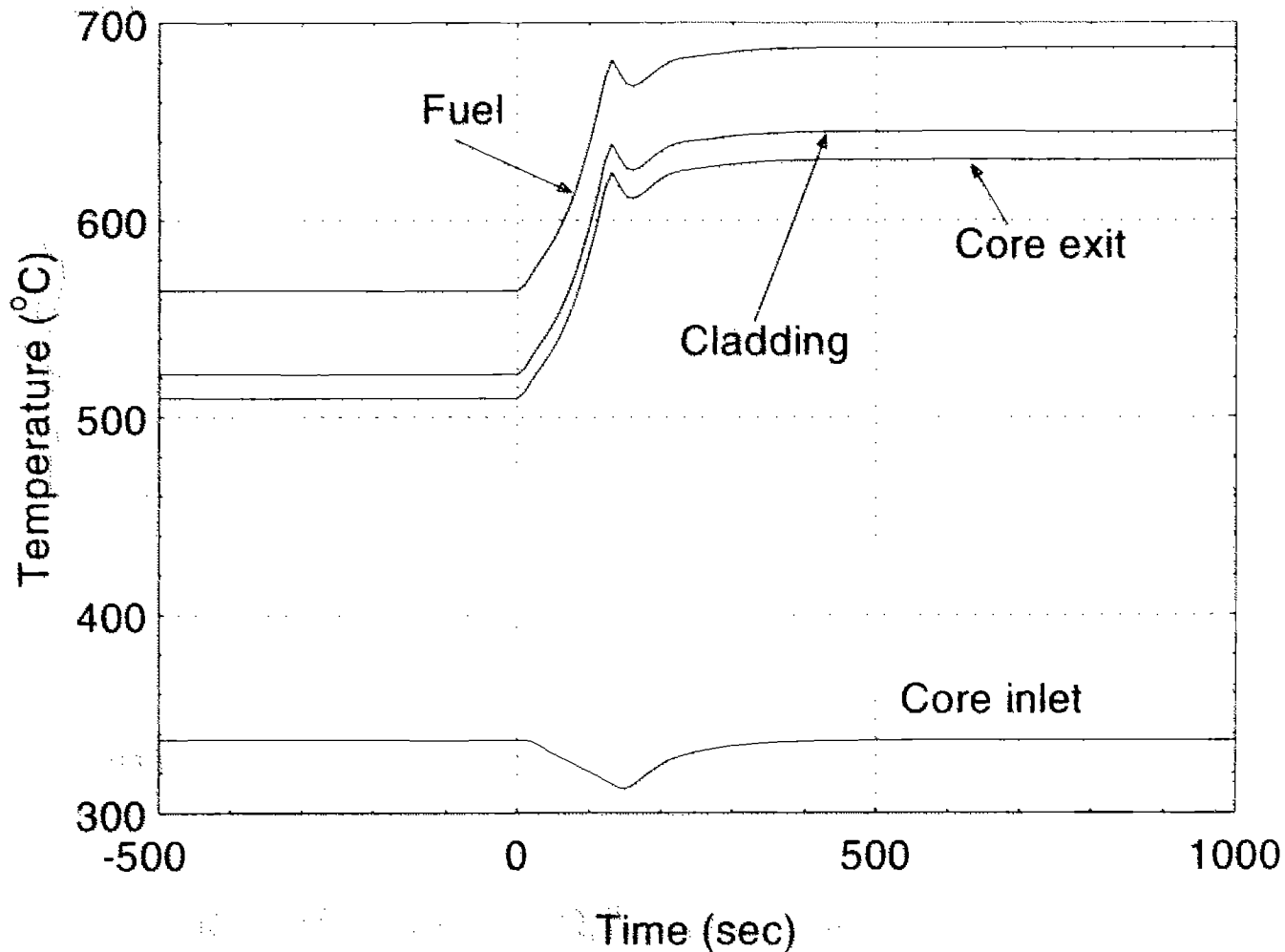

# Loss of Heat Sink Accident (Beam Off, IHX Off, Pump Off)

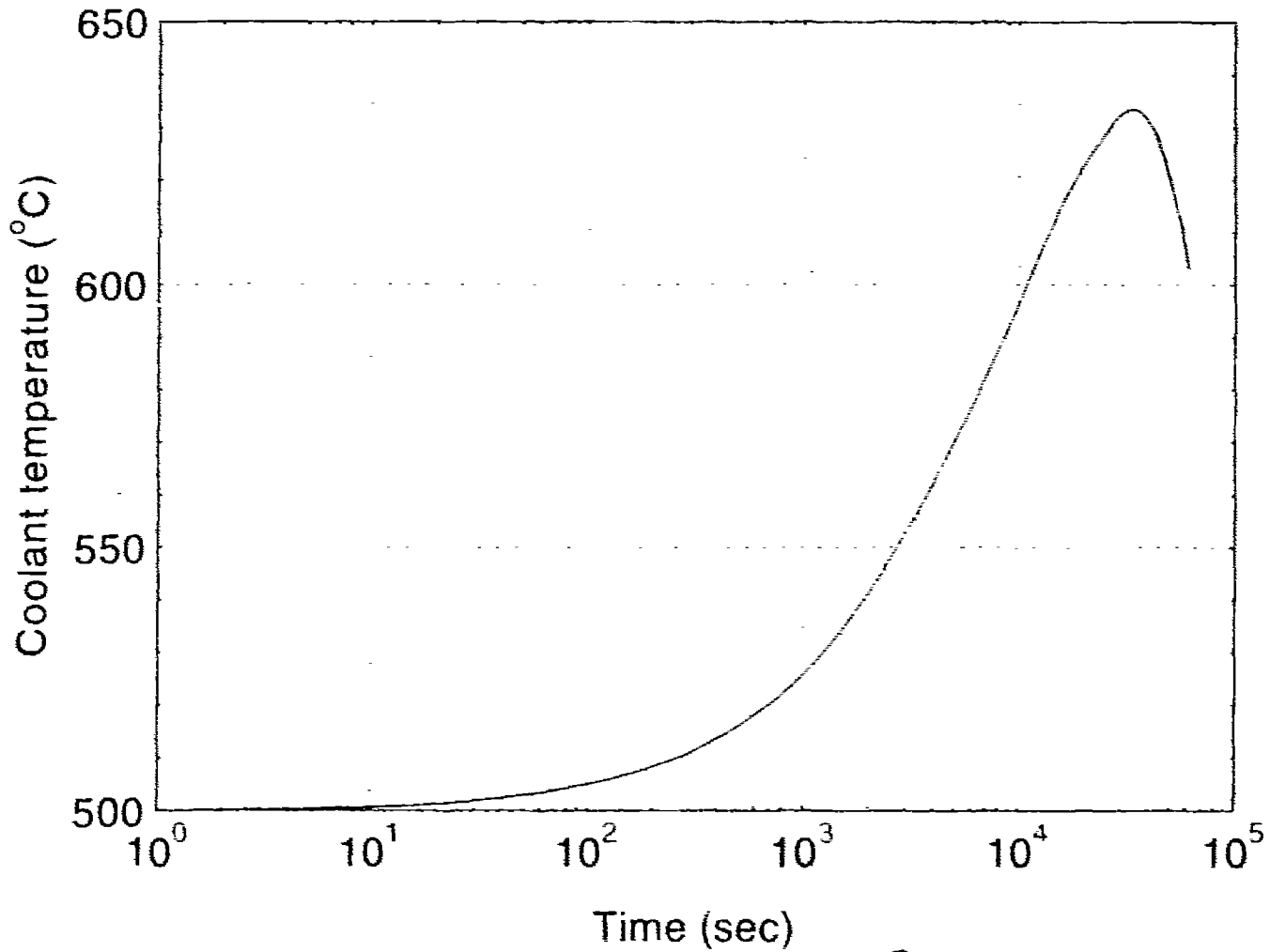

# PASSIVE SAFETY CORE "SHUTDOWN"

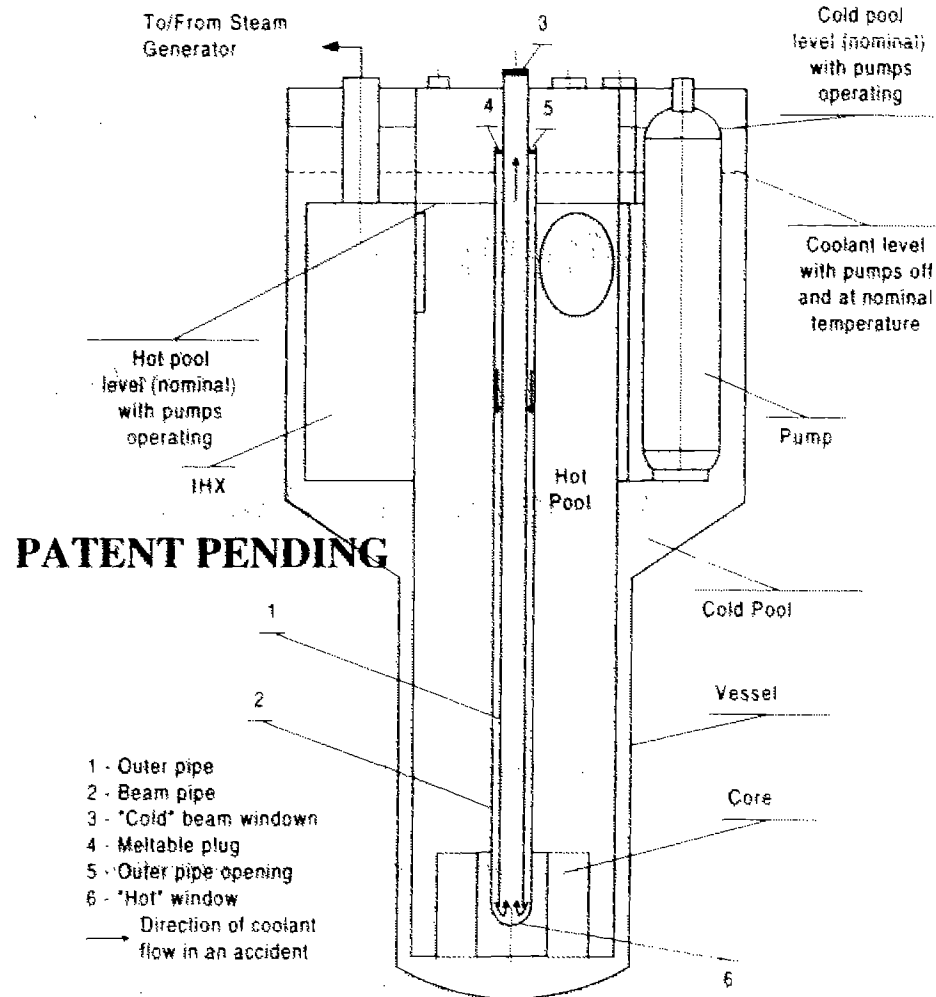

# FUTURE HIGH PRIORITY ANALYSES

---

- **Detailed core physics/power distribution**
- **Core orificing**
- **Reactivity insertion transients**
- **Window design**
- **Reactivity swing over lifetime**
- **Fuel management**



# SUMMARY CONCLUSIONS

---

- **Established Design Philosophy and Exercised Design Choices**
- **Taken Maximum Advantage of Past Experience**
- **Established Necessary Framework for Technology Transfer**
- **Preliminary Performance Calculations are Very Encouraging**
- **Excellent Passive Safety Capabilities and Potential**
- **Outlined Plan for Next Step in Design**

# **ATW Nuclear Performance**

Los Alamos National Laboratory

- ATW Project -

Presented by: Michael G. Houts

Nuclear Systems Design and Analysis Group

Prepared with: David I. Poston and Holly R. Trelue

# Outline

- ATW System Description
- Experience Base for the ATW
- ATW Safety
- ATW Waste Cycle
- Technetium Transmutation
- End-of-Life (EOL) Inventory Reduction
- Research Needs
- Conclusions

# ATW System Description

- The ATW point design is not yet optimized, but is intended to meet ATW goals:
  - Less than 3000 kg steady-state actinide inventory.
  - Greater than 500 kg/year actinide burnup.
  - Greater than 40 kg/year technetium transmutation.
- The ATW point design has a lower inventory and a higher burnup rate than the ATW Demo.
- The ATW Demo and the Subcritical Testbed Facility provide the data and experience necessary to build the ATW.

# ATW Builds on the ATW Demo

<b>Parameter</b>	<b>ATW Demo</b>	<b>ATW</b>
Coolant	44.5%Pb / 55.5%Bi	44.5%Pb / 55.5%Bi
Power (MWt)	1000	2000
Fissioning Material	(Np/Pu/Am/Cm)Zr	(Np/Pu/Am/Cm)Zr
Power Density (MW/liter)	0.076	0.34
Vessel Material / Clad Material	316 SS / 316 SS	316 SS / 316 SS
Average Linear Heat Rate (kW/ft)	6.4	7.3
Fuel Cycle, Nominal (Full Power Days)	360	100
Actinide Inventory, no Tc Burning (kg)	4900	2400
Actinide Inventory, with Tc Burning (kg)	6400	2960
Average Coolant Velocity (m/s)	1.2	< 5
Prompt Reactivity Feedback	Near-Zero	Near-Zero
Overall Reactivity Feedback	Negative	Negative

# **The ATW Demo will have Demonstrated Key Requirements and Features of ATW**

- Beam transport and beam window.
- Flowing LBE target.
- Assured beam shutoff (or removal of spallation source from waste region).
- Operation with small delayed neutron fraction.
- Operation with near-zero prompt reactivity feedback.
- Operation with uncertainties in the composition and physics of the waste.

**In addition to utilizing Russian LBE reactor experience, ATW also stays within relevant FFTF experience.**

<b>Parameter</b>	<b>FFTF</b>	<b>ATW</b>
Power Density (MW/liter)	0.39	0.34
Vessel Material / Clad Material	304 SS / 316 SS	316 SS / 316 SS
Average Linear Heat Rate (kW/ft)	7.3	7.3
Fuel Cycle, Nominal (Full Power Days)	100	100
Demonstrated Capacity Factor	0.75	Not Known
Average Coolant Velocity (m/s)	6.4	< 5
Coolant delta-T (C)	170	250
Prompt Reactivity Feedback	Negative	Near-Zero
Overall Reactivity Feedback	Negative	Negative
Coolant	Sodium	44.5%Pb / 55.5%Bi
Power (MWt)	400	2000
Fissioning Material	25%PuO <sub>2</sub> /75%UO <sub>2</sub>	(Np/Pu/Am/Cm)Zr

# ATW has Excellent Neutronic Safety Characteristics

Keff vs Percent Compaction  
2 m x 2 m Waste Region, Steady-State

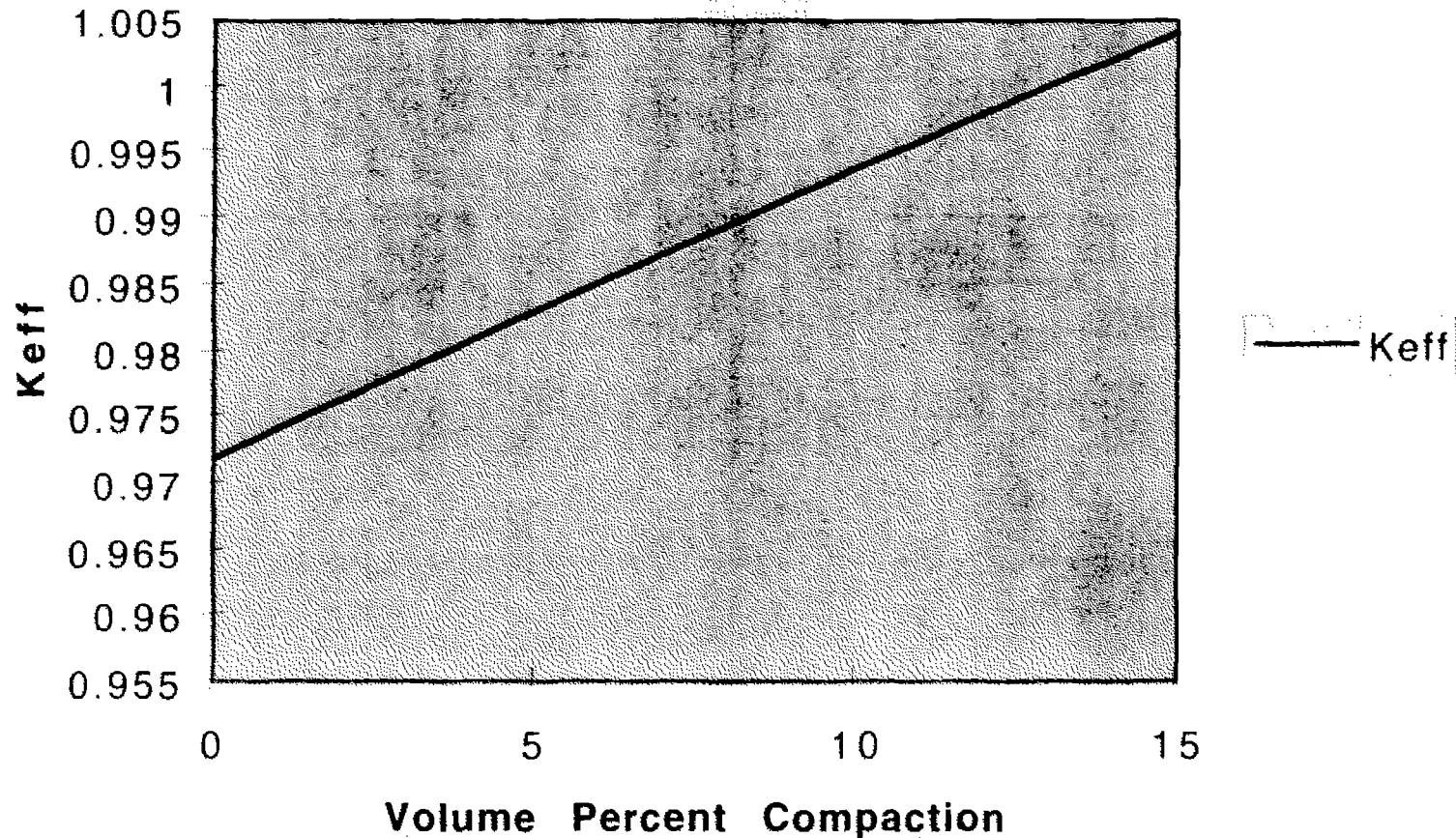

ATW retains subcriticality with up to 13% volumetric compaction.



# ATW has Excellent Neutronic Safety Characteristics

## Relative Power vs Keff Assuming Constant Neutron Source

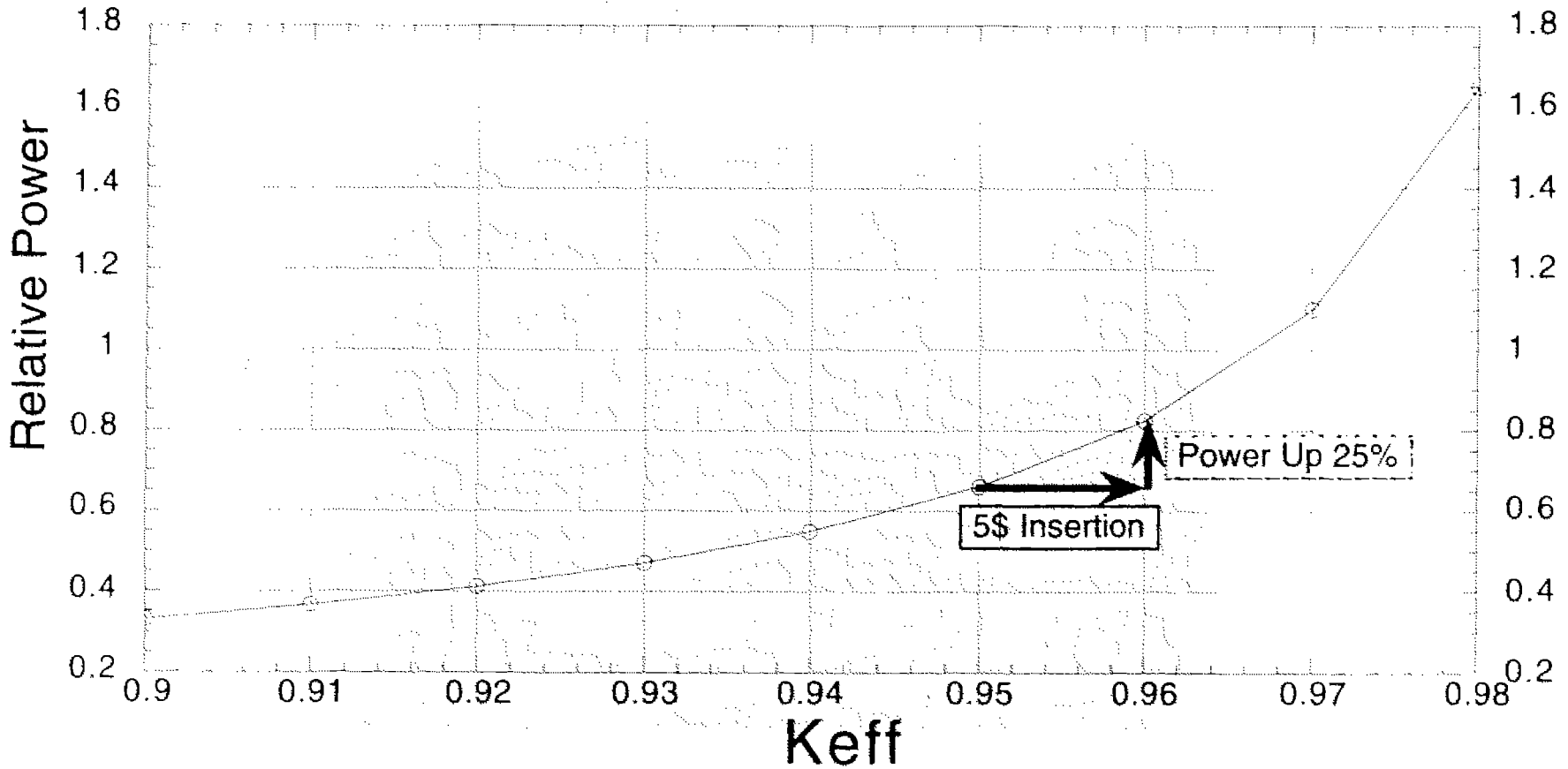

Large reactivity insertions result in small power increases.  
Fission power rapidly drops to zero if source is removed.

# **Simple Waste-Burning Scenarios give Adequate Performance**

- 3-zone scheme has adequate performance (improvements possible).
- “Fresh” waste pins placed in Zone 3, moved to Zone 2 after 1st burn cycle and Zone 1 after 2nd burn cycle.
- After burn cycle in Zone 1, waste is processed, actinides concentrated to obtain desired reactivity, and waste refabricated into pins. Then waste inserted into Zone 3.

# Simple Waste-Burning Scenarios give Adequate Performance

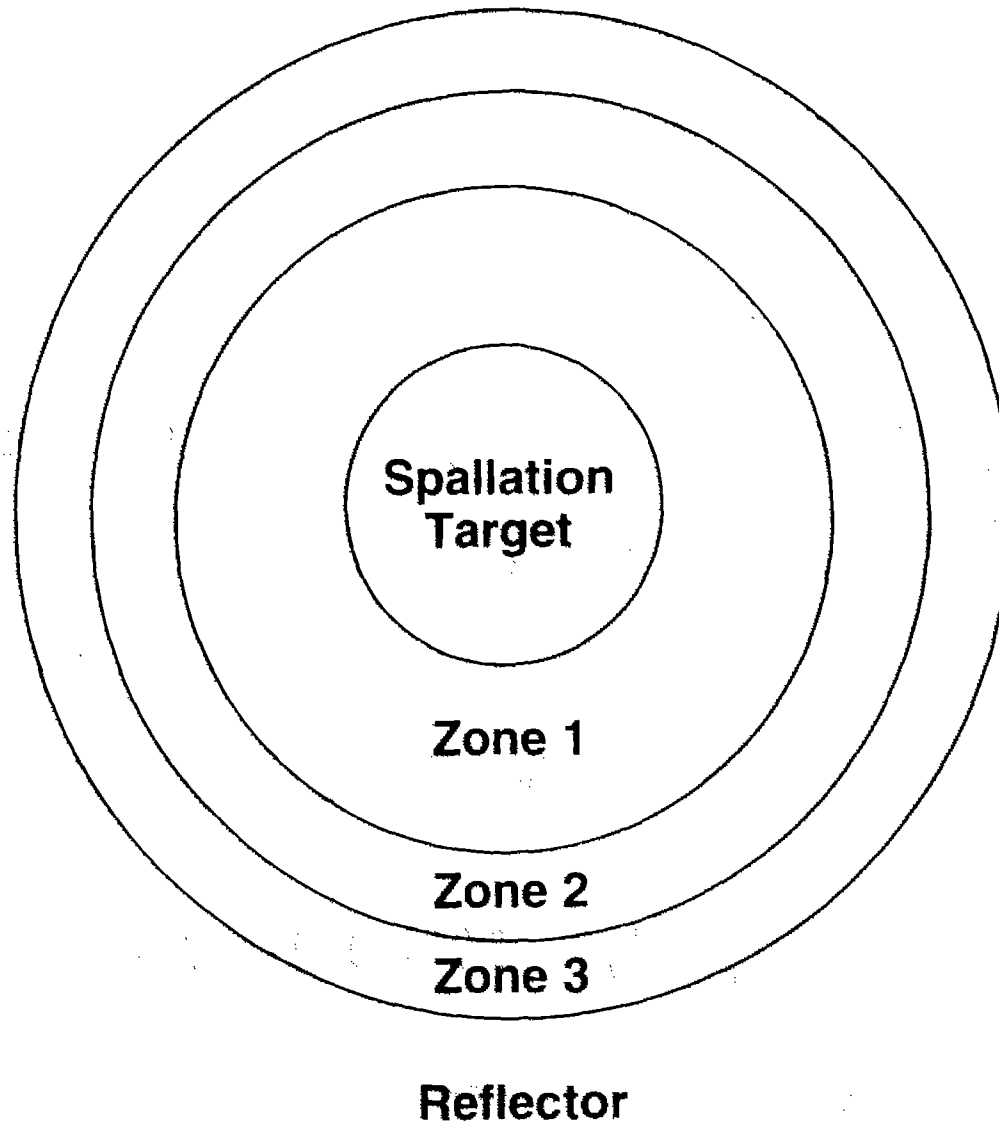

*Core Map for 2000 MWt  
ATW Burner*

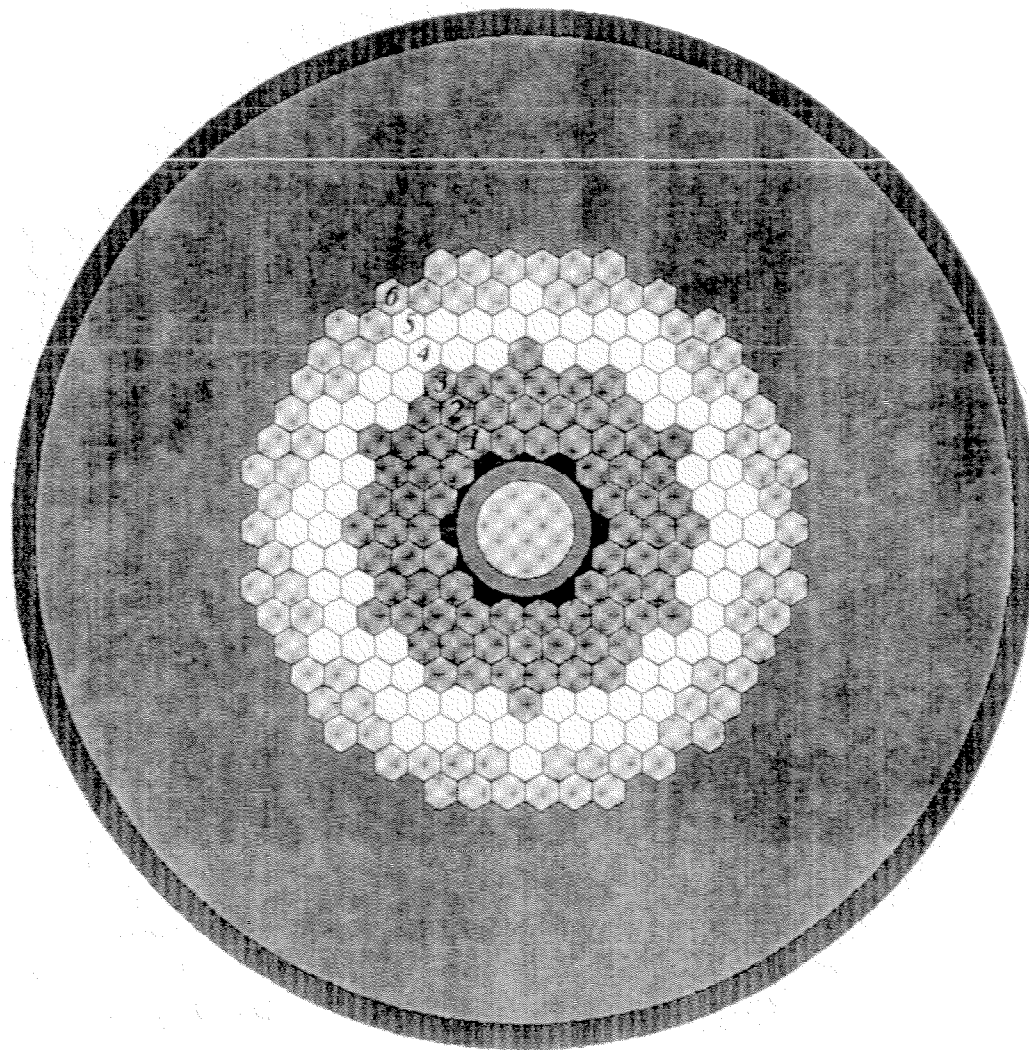

200 cm

# ATW Steady-State Waste Cycle

## Isotopics of Steady-State ATW Batch (2-GW, 4 month burn cycle)

Batch moves R3-R2-R1; then actinides concentrated and enriched with LWR discharge, and moved into R3  
(the difference between the first and last bar is the SS feed rate, except for U238)

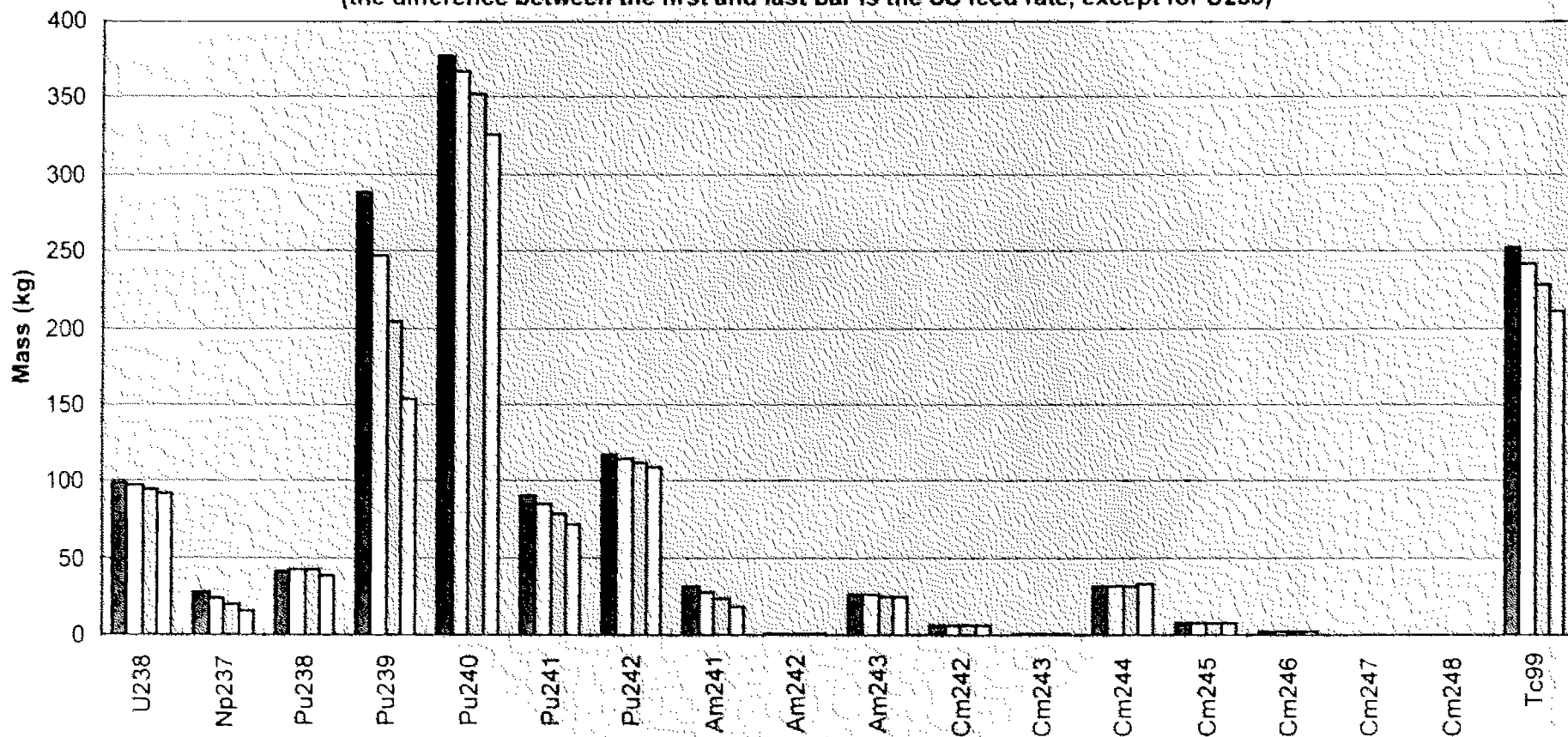

- Into region 3 (0 mo.) - 1055 kg of transuranic
- Into region 2 (4 mo.) - 990 kg of transuranic
- Into region 1 (8 mo.) - 915 kg of transuranic
- Out of region 1 (12 mo.) - 815 kg of transuranic

System transuranic inventory  
Beginning of cycle = 2960 kg  
End of 4 mo. cycle = 2720 kg  
(40 kg Tc99 burned per cycle)

# PWR vs ATW Discharge

Isotopics of PWR Discharge vs. ATW SS Discharge

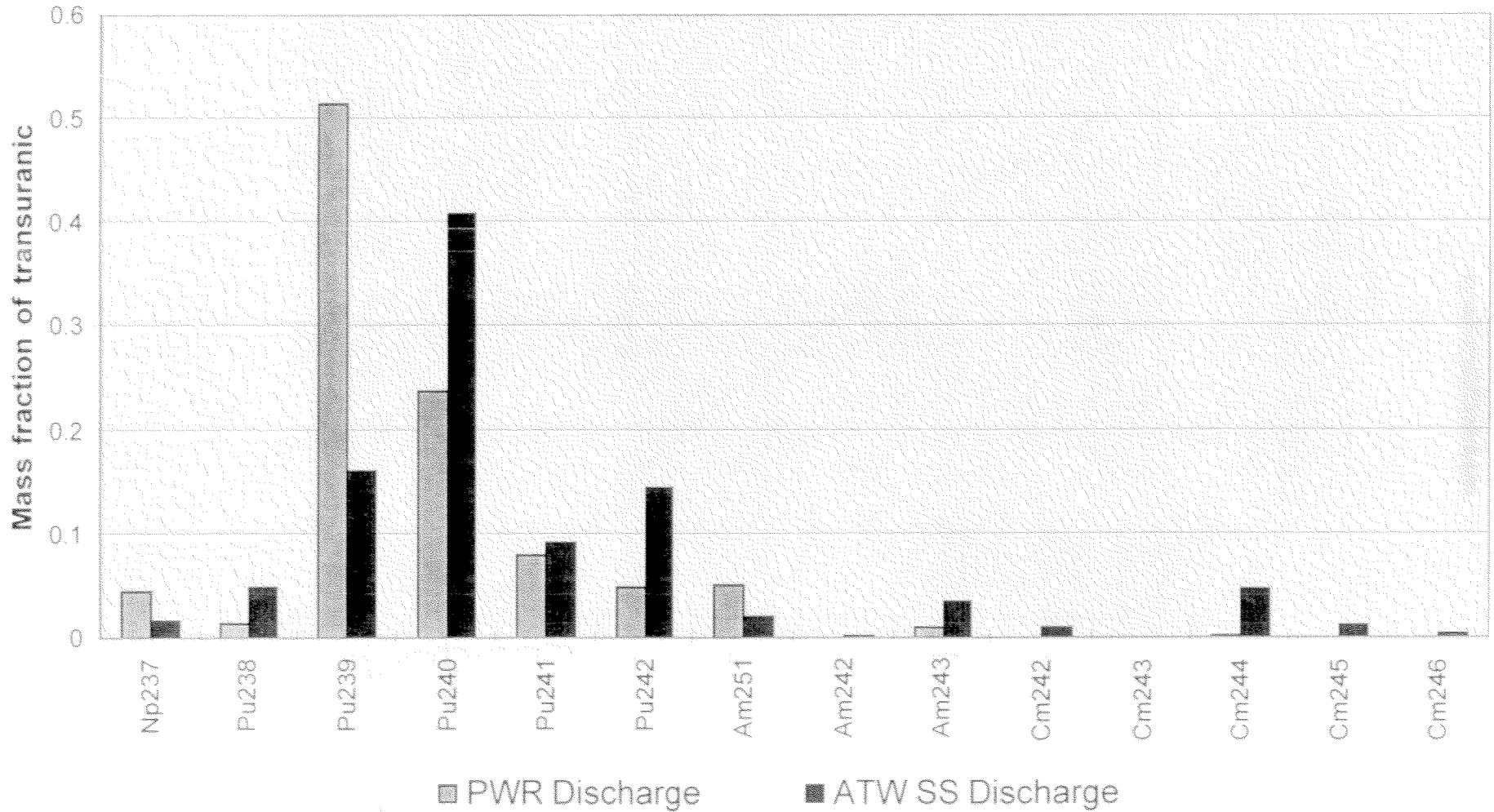

# ***Variable accelerator drive provides constant power operation under extended burnup, without fertile materials***

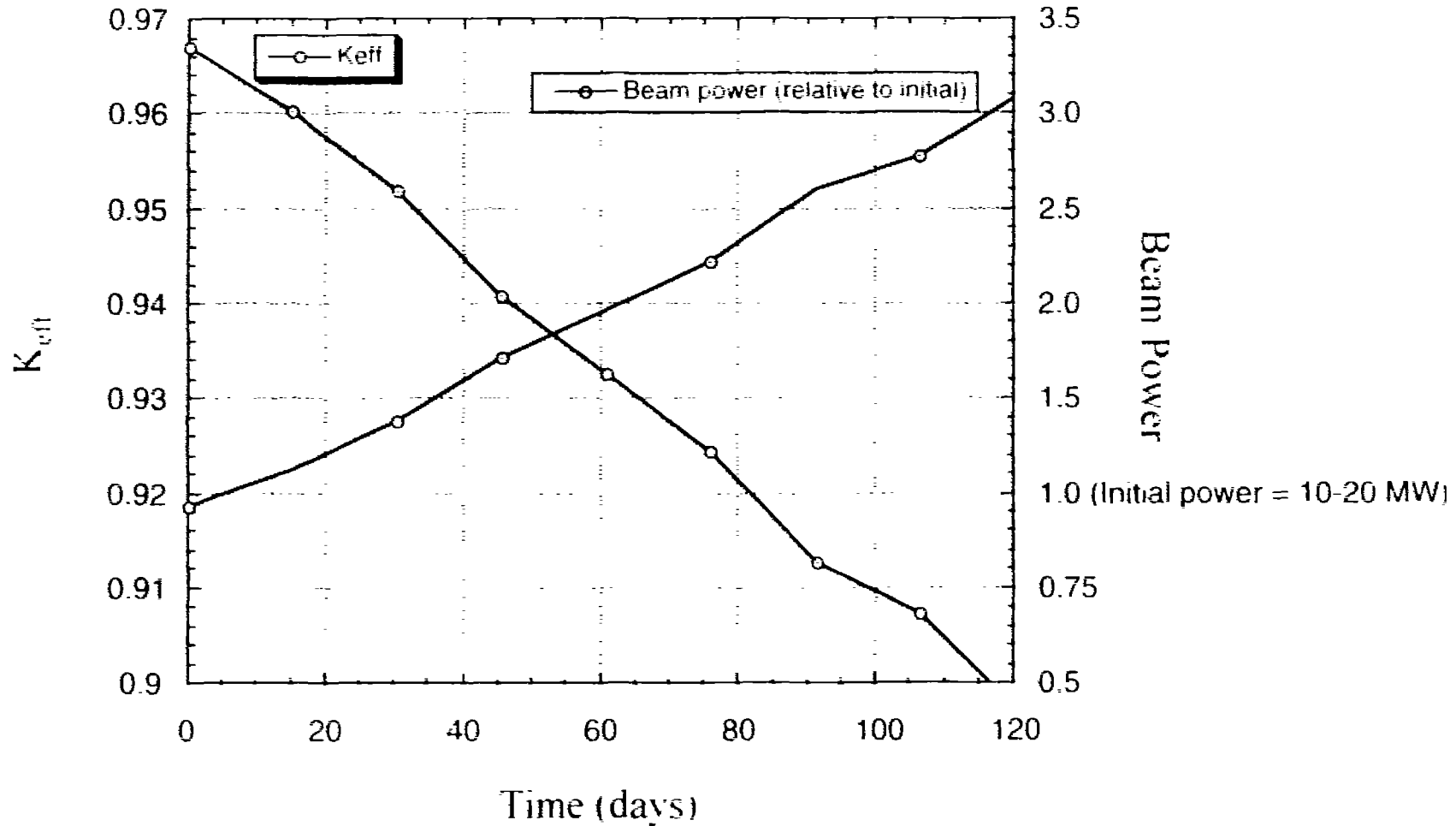

*.... we don't have to resort to liquid fuels*

# ATW has an Acceptable Power Profile

Relative Power Density vs Radial Position

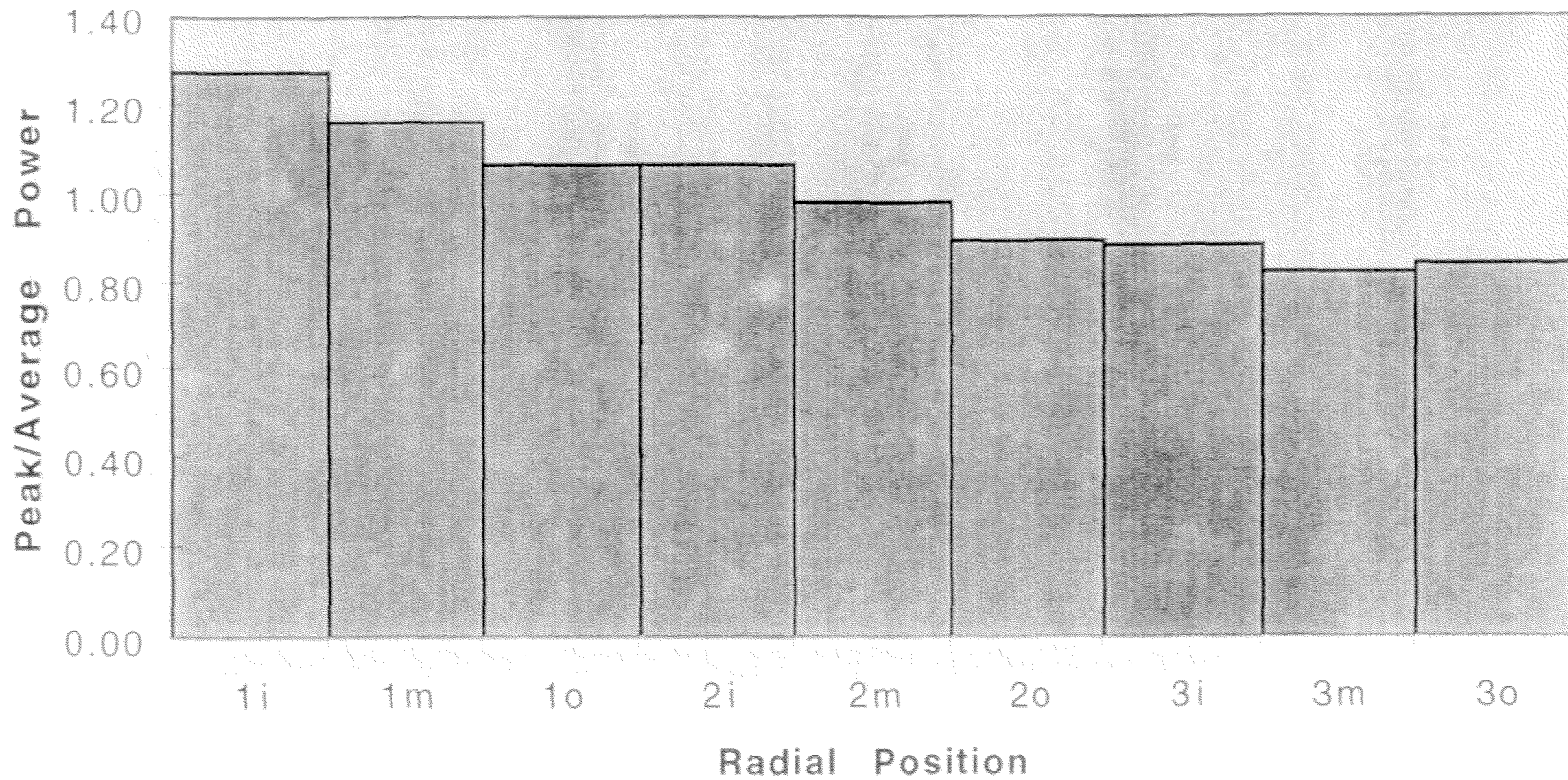



# ATW has an Acceptable Power Profile

Relative Power Density Vs Axial Position (cm)

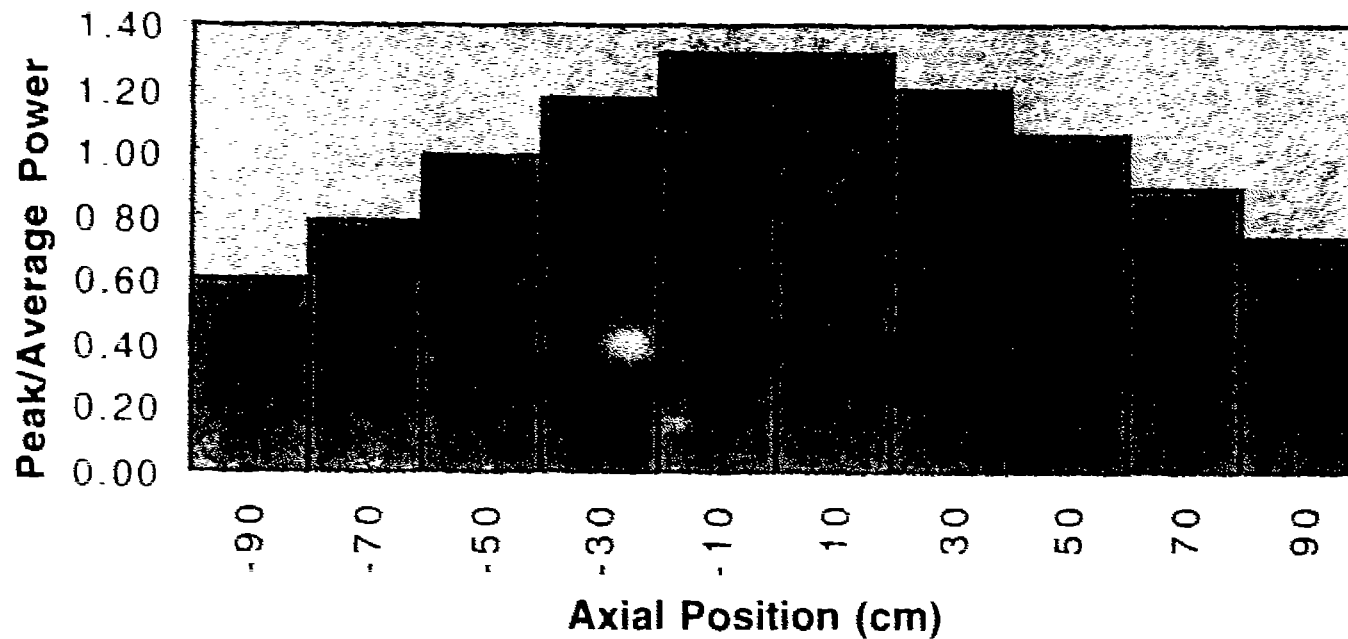

# ATW Efficiently Transmutes Technetium

- Increases actinide loading and acceptable cycle length.
- Hardens neutron spectrum if unmoderated, increasing  $\eta$  and reducing build-in of higher actinides.
- Moderated targets allow use of Tc as burnable poison, and increase Tc transmutation rate.

# ATW Efficiently Transmutes Technetium

- Tc transmutation rates greater than the required rate (40 kg/yr) are easily attainable.
- Highest transmutation fraction attained by closely mixing Tc with moderator pins.
- More than adequate Tc transmutation feasible through use of moderated targets radially surrounding the fissioning region or possibly Tc impregnated end-reflectors within the fuel pins.
- Fast-spectrum transmutation of Tc in the fissioning region also has reasonable performance.

# Effect of Tc Addition in Actinide

Actinide Mass Fractions with and without Fast-Spectrum Tc Transmutation in Actinide Region

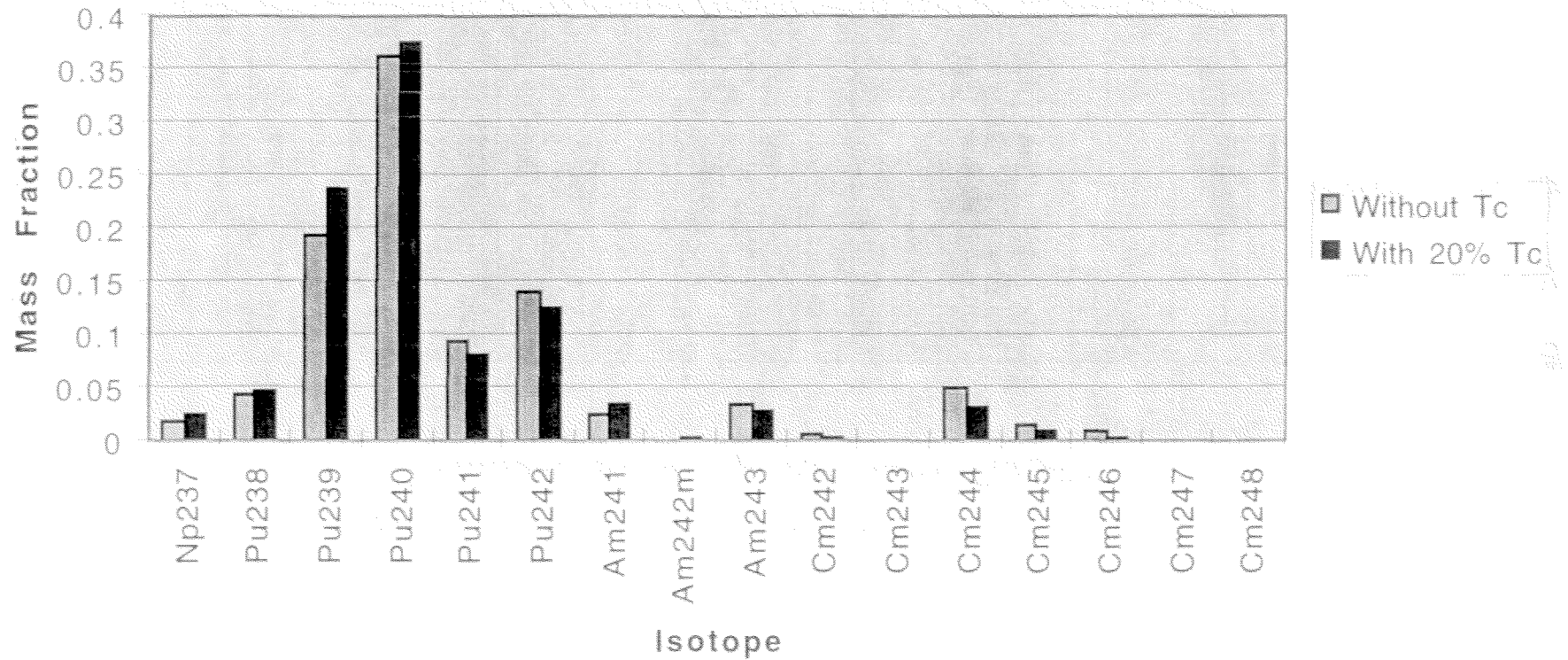

# Effect of Tc Addition in Actinide Burning Region

Curium Fraction in Fuel with and without Fast-Spectrum Tc Transmutation in Actinide Region

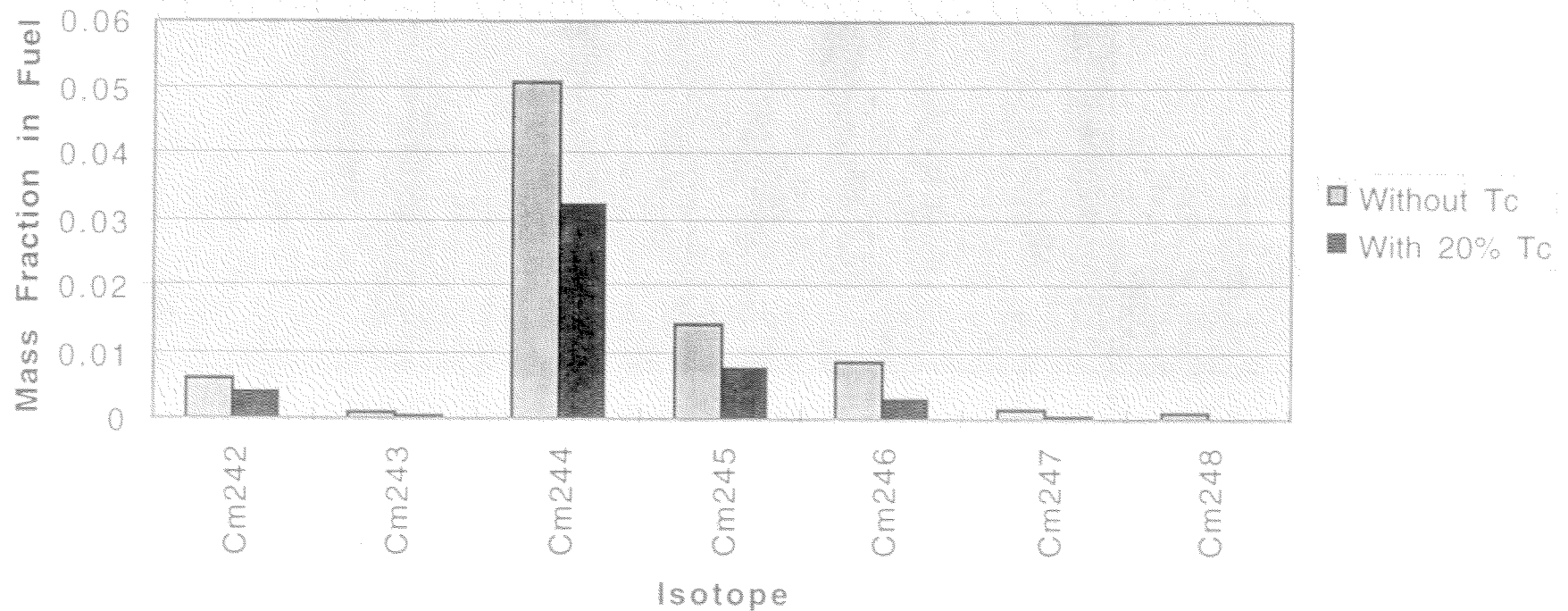

# ATW Inventory Reduced at EOL

- When a plant reaches end of operational lifetime (EOL), residual actinide inventory transferred to remaining plants.
- The final remaining site (Two 2 GWt plants) will be used for burn-down.
- As inventory drops, actinides are concentrated, waste region size reduced, and power is reduced as needed. Fast spectrum maintained as long as practical.
- Moderator introduced at EOL to attain very low (100 kg) residual inventory while maintaining reasonable multiplication.
- Reduce residual Np and Tc inventories to less than 5 kg.

# Waste Mixtures with no Plutonium can be burned.

Actinide Loading and Power Density vs Actinide Fraction in Fuel (1000 MWt)

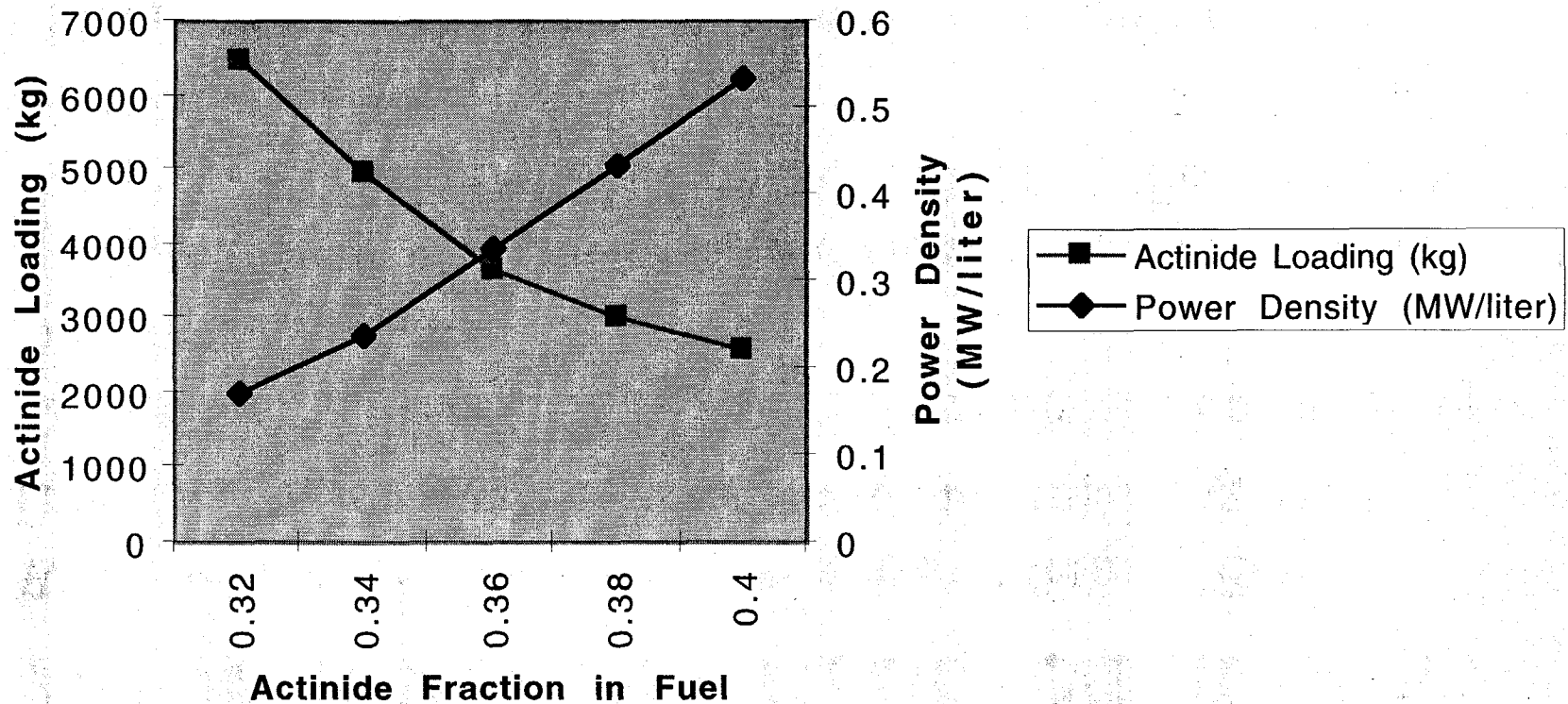

# Research Needs from Subcritical Test Facility and ATW Demo

- Fuel (Waste) Performance (Demo)
  - High actinide burnup.
- Fuel (Waste) Handling (Demo)
  - Rapid shuffling, removal, and insertion.
- Materials (STF)
  - Relatively high LBE flow velocity and delta-T.
- Interface between beam and waste burner (Demo & STF).
  - High beam power, beam power density.



# Summary

- A logical path exists for developing ATW systems.
- ATW has excellent neutronic safety characteristics.
- ATW burns actinides efficiently.
- ATW transmutes technetium efficiently.
- ATW has a low EOL actinide inventory.
- ATW fuel is well suited for processing.
- ATW reduces actinide and technetium waste inventories by 3 orders of magnitude.

# ***ATW Process Chemistry***

**Los Alamos National Laboratory  
- ATW Project-**

**Presented by: Mark A. Williamson  
Nuclear Materials Technology Division**

# *Outline*

---

- **ATW process chemistry requirements**
- **ATW waste treatment flow chart**
- **Process chemistry simulations**
  - **LWR spent fuel**
  - **ATW waste treatment**
- **Waste streams**
- **Technetium and ATW**
- **Conclusions**

# *ATW Process Chemistry is Proliferation Resistant and not Complex*

---

- **Transuranics are separated as a group for burning in ATW, no weapons usable material is produced during processing**
- **Technetium and iodine are separated for transmutation in ATW**
- **Secondary waste minimized**
- **Segregated waste materials produced for storage**

# ATW Waste Treatment

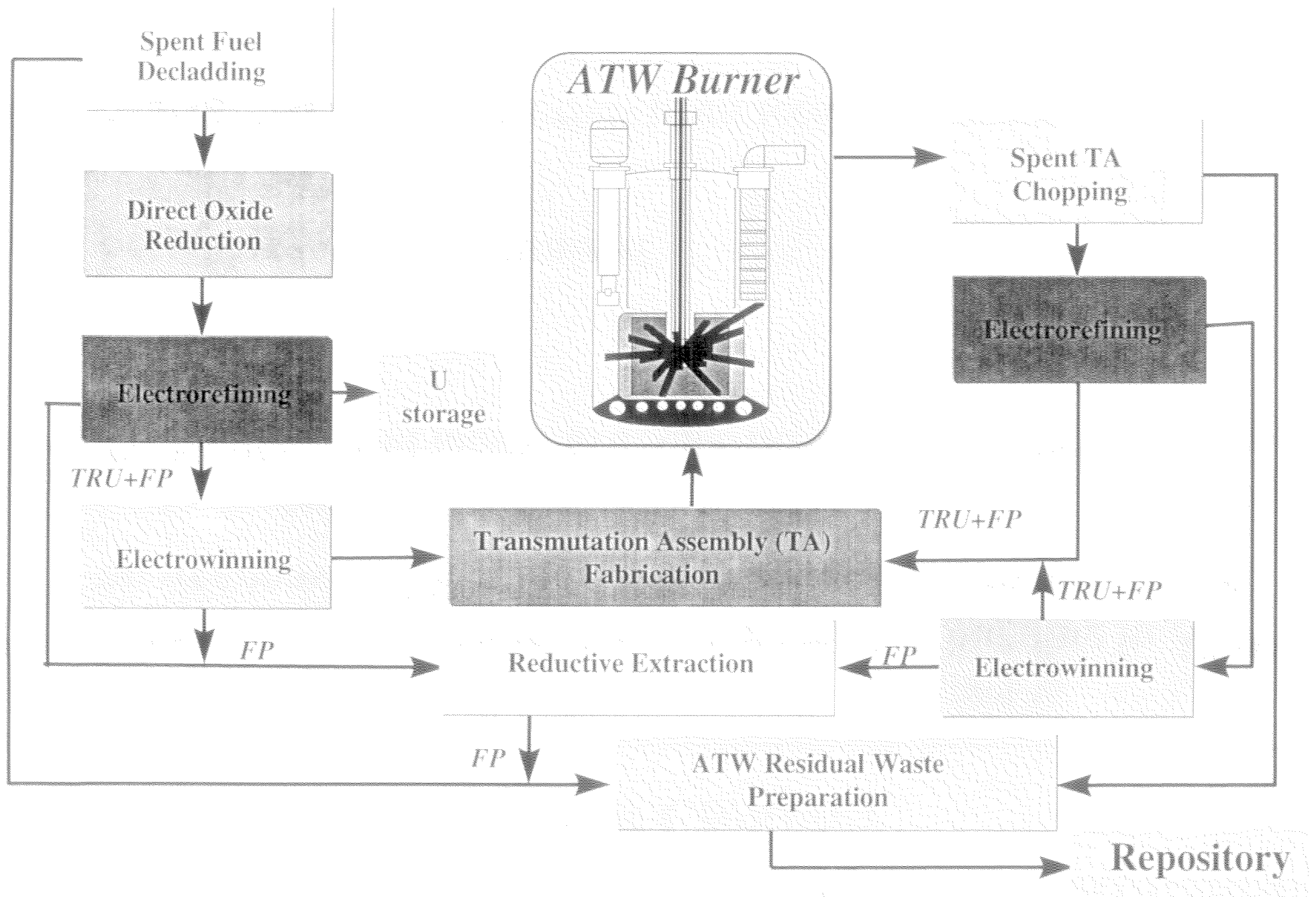

# *AI W Process Simulation Routines Benchmarked with Experimental Data*

---

- **SOLGAS** - equilibrium thermodynamic calculations based on free energy minimization, routinely used in process simulations for 25 yrs
  - Direct Oxide Reduction (DOR)
  - DOR salt regeneration
- **TRAIL** - mass transfer modeled with diffusion layer theory, Kobayashi et al., *J. Alloys and Compounds* 197, 7 (1993), code written by Y. Hu and N. Li, verified with U electrorefining data
  - Electrorefining
  - Electrowinning

# LWR Waste Treatment Flow Chart

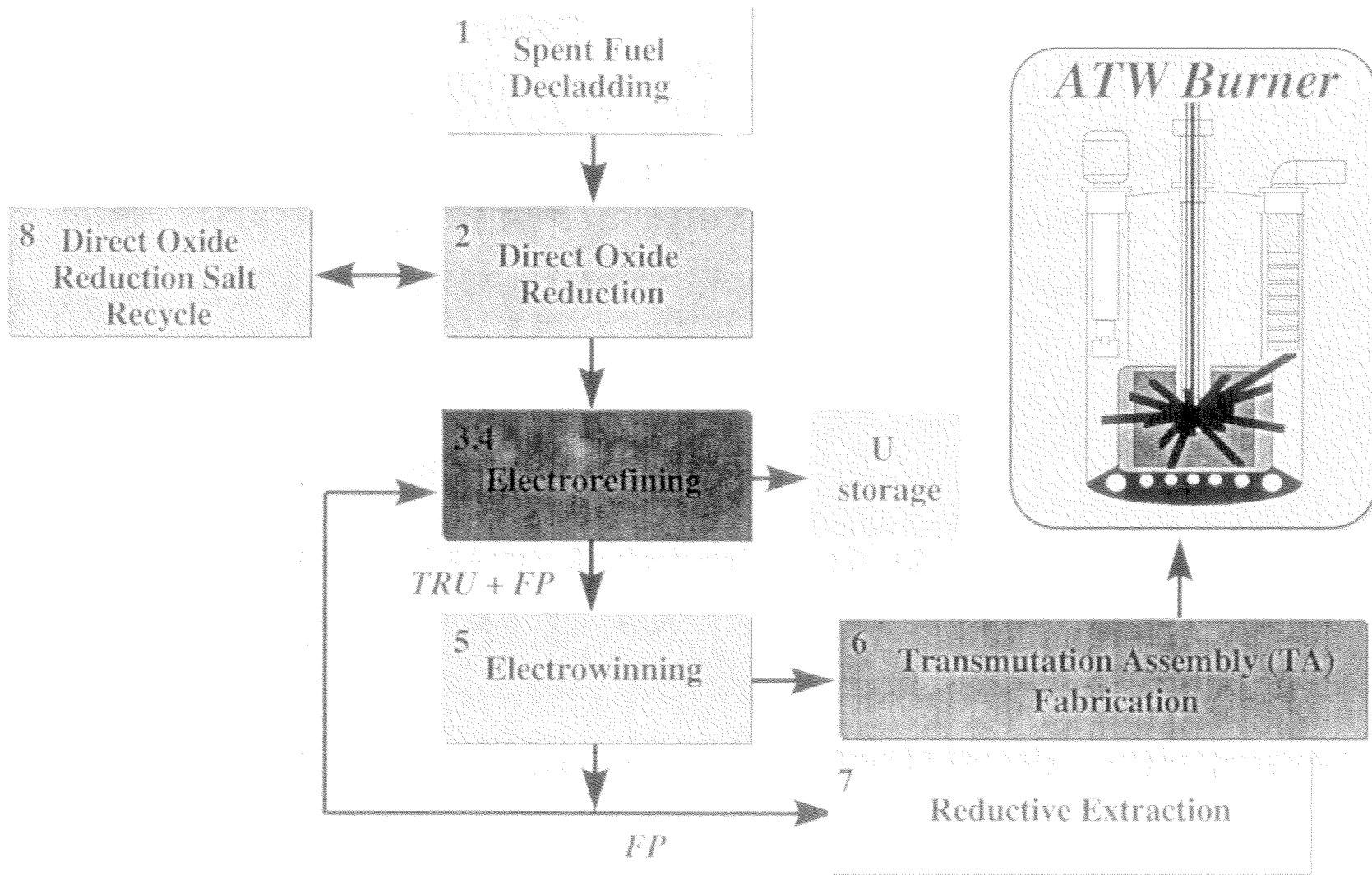

# *LWR Waste Treatment Simulation*

- **One PWR fuel assembly**
- **33 MW day / kg average burn-up**
- **150 days cooling time**
- **Composition data from Nuclear Chemical Engineering, Benedict, Pigford, and Levi**



# *Spent Fuel Decladding Produces Feed Material for Oxide Reduction Process*

---

**1**

- **Support hardware removed from assembly**
- **Pins chopped by traditional methods**
- **Oxide fuel separated from clad material, sent to oxide reduction process**
- **Clad used as source of Zr for ATW fuel**
- **Offgas released by decladding process is collected, sent to storage**

# *Oxide Fuel Converted to Metal by Direct Oxide Reduction Process*

2

## Input Materials

455 kg oxide from #1

135 kg Ca

1870 kg CaCl<sub>2</sub>

## Operating Conditions

T = 1125 K

Time = 8 hrs

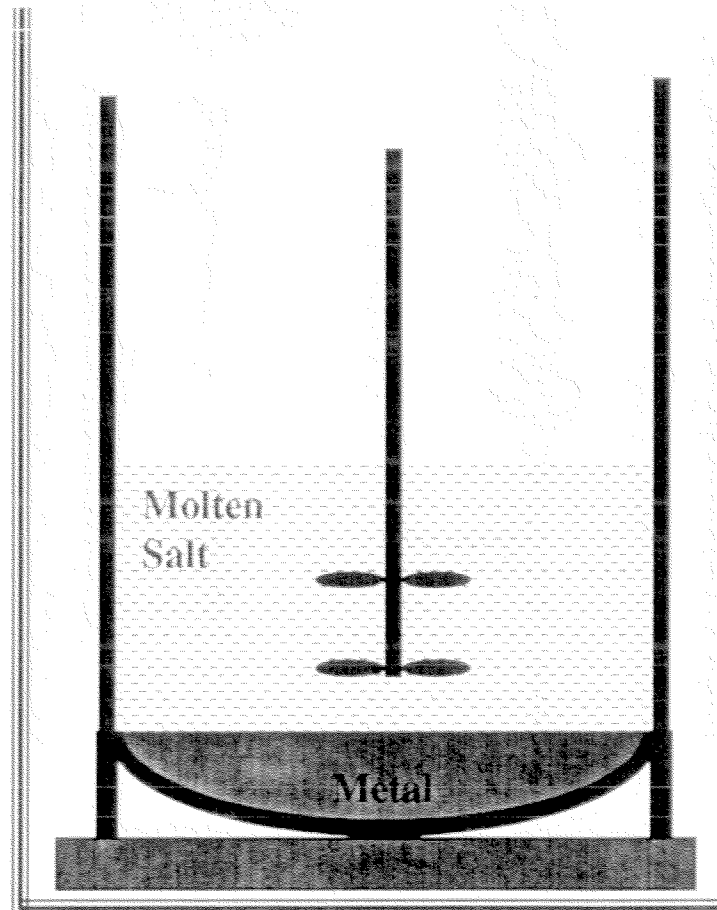

## Output Materials

### Molten Salt to #8

2 kg Cs, Sr, Ba

189 kg CaO

1870 kg CaCl<sub>2</sub>

### Metal to #3

398 kg HM

### Offgas

1 kg Xe, Kr

Four 100 kg HM batches are required to treat one PWR fuel assembly

# *Electrorefining of PWR Assembly Provides Uranium Separation*

3

## Input Materials

398 kg HM from #2

385 kg U

3.98 kg TRU

3.98 kg RE

20 kg U<sup>3+</sup>

188 kg NaCl-KCl

## Operating Conditions

I = 500 A

Time = 265 hrs

T = 1000 K

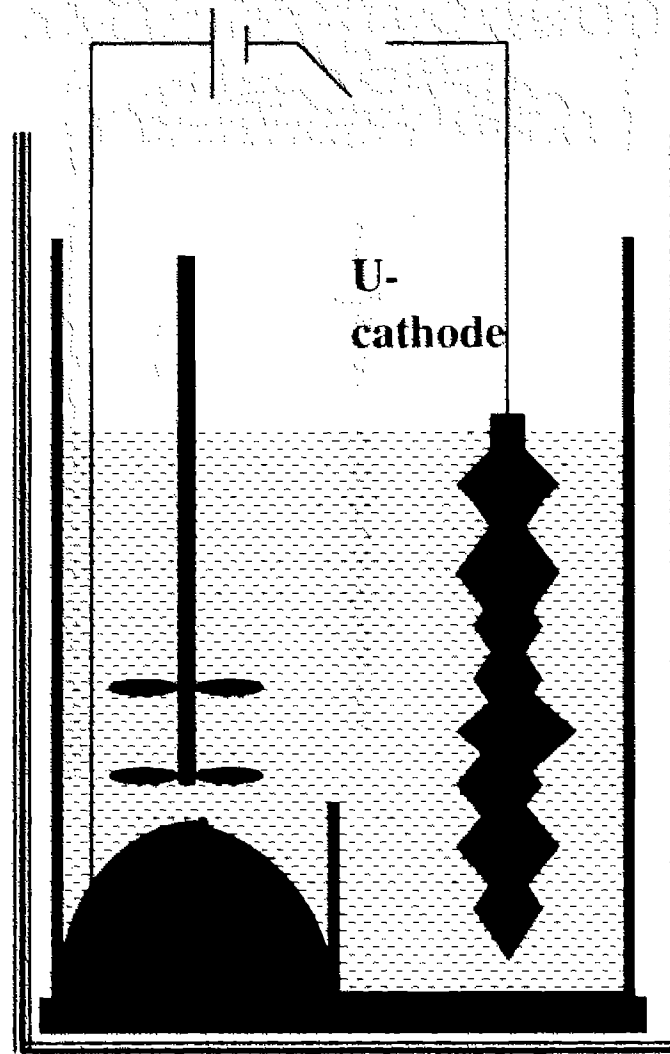

## Output Materials

### Anode to #4

5040 g NM

2800 g U

15 g TRU

14 g RE

### Molten Salt to #5

10200 g U

3965 g TRU including Np

3966 g RE

188 kg NaCl-KCl

### Cathode

392 kg U

Four Batches of 99.5 kg HM with U<sup>3+</sup> re-enrichment to 6% in molten salt

# Polishing Anode from Electrefining Process Reduces TRU Discharge

4

## Input Materials

anode from #3

5040 g NM

2800 g U

15 g TRU

14 g RE

1120 g U<sup>3+</sup>

18.8 kg NaCl-KCl

## Operating Conditions

I = 500 A

Time = 2 hrs

T = 1000 K

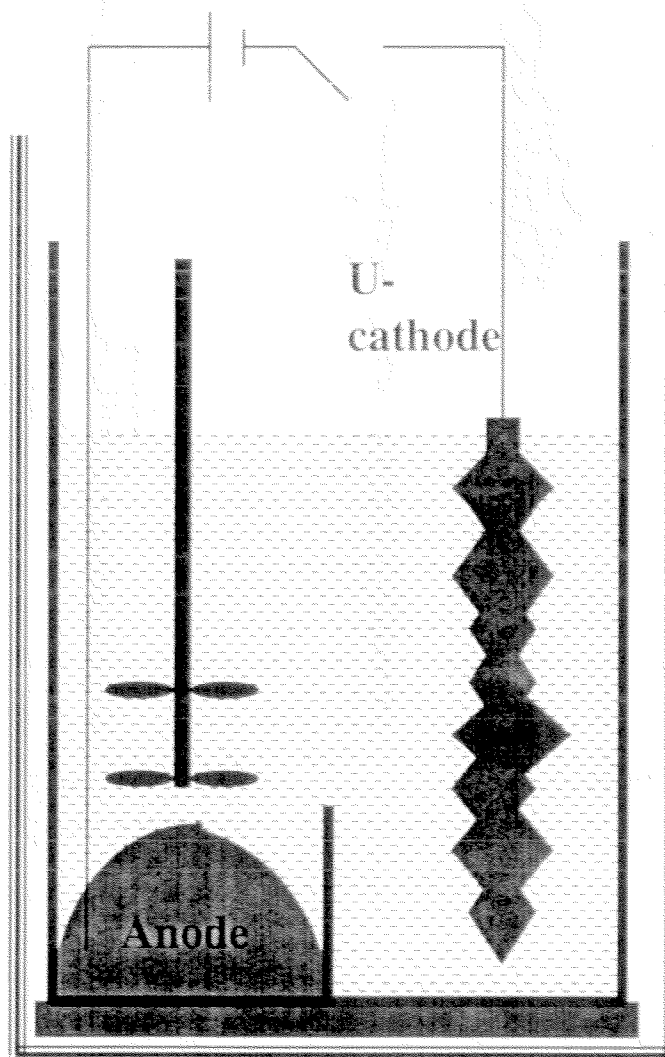

## Output Materials

### Anode

5010 g NM

0.15 g U

0.045 g TRU

0.129 g RE

### Molten Salt to #3

28.5 g NM

987.1 g U

14.955 g TRU including Np

13.871 g RE

18.8 kg NaCl-KCl

### Cathode

1.5 g NM

2932.75 g U

Material from one PWR assembly

# *Electrowinning Provides Feed Material for ATW Fuel Fabrication*

5

## Input Materials

molten salt from #3

10200 g U

3965 g TRU

3966 g RE

4334 g Na as alloy

188 kg NaCl-KCl

## Operating Conditions

$I = 500 \text{ A}$

Time = 6.2 hrs U

3.7 hrs U/TRU/RE

$T = 1000 \text{ K}$

Sacrificial  
Anode

Cathode

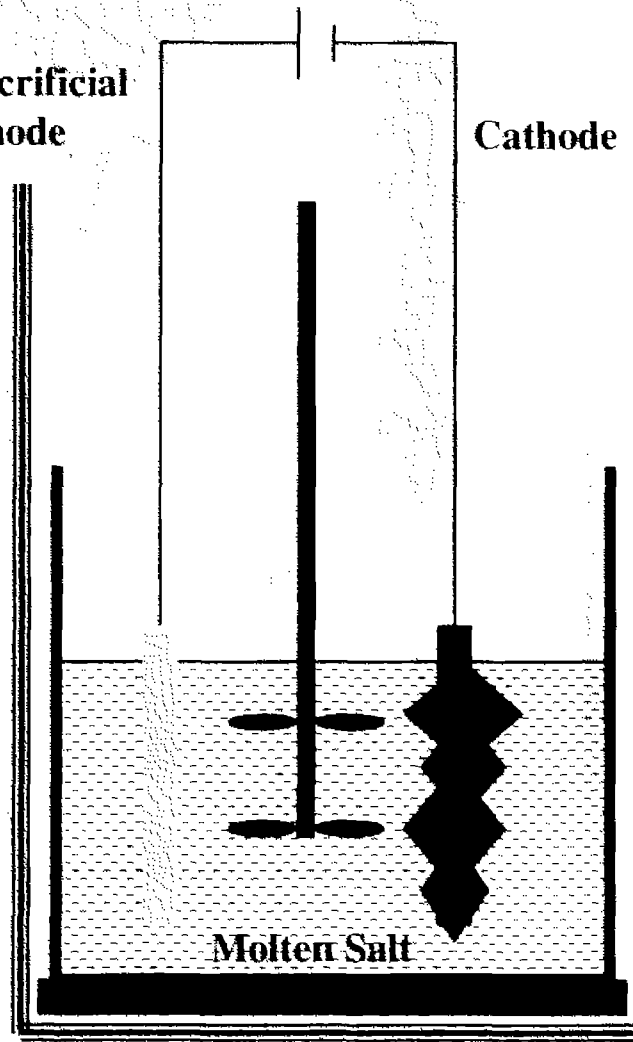

## Output Materials

Molten Salt to #7

3466 g RE

192.3 kg NaCl-KCl

Cathode

U extraction

9200 g U

U/TRU/RE extraction  
to #6

1000 g U

3965 g TRU

500 g RE

Material from one PWR assembly

# *Fuel Fabrication for ATW system*

6

## Input Materials

metal from #5

1000 g U

3965 g TRU

500 g RE

14775 g Zr from #1

## Operating Conditions

$T = 1900 \text{ K}$

Moderate Vacuum

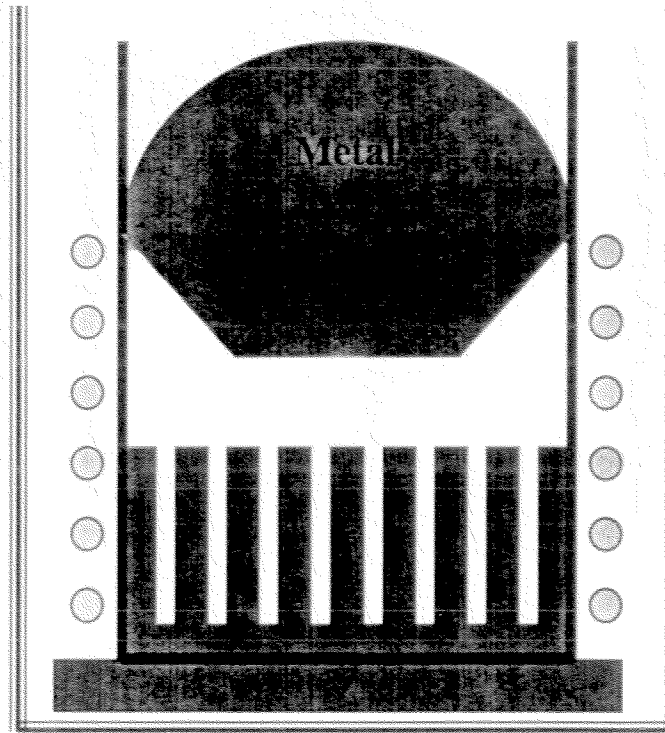

## Output Materials

20240 g alloy fuel

## Fuel Preparation

1. rods machined to proper diameter

2. rods cut into pellets for use in fuel pins

High Temperature Vacuum Casting Furnace

# *Reductive Extraction Process Removes Rare Earths from Molten Salt*

7

## Input Materials

Molten salt from #5  
3466 g RE

1707 g Na as alloy  
188 kg NaCl-KCl

## Operating Conditions

Time = 8 hrs  
T = 1000 K

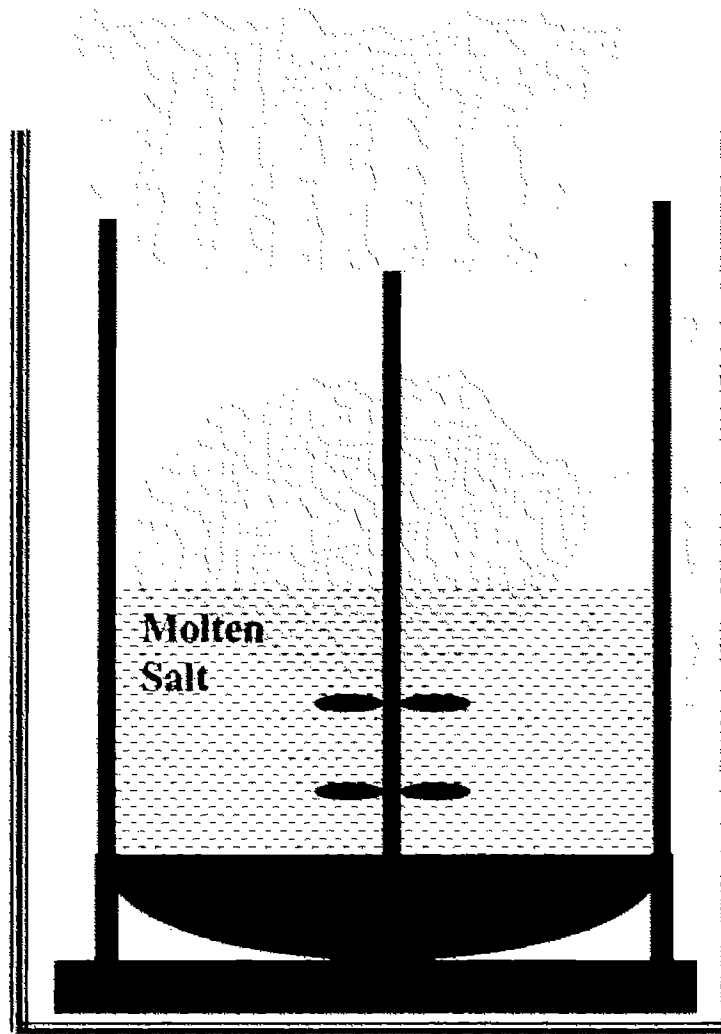

## Output Materials

Molten Salt to #3  
189 kg NaCl-KCl

Metal Phase  
3466 g RE

# *Direct Oxide Reduction Salt is Recycled after Chlorination and Calcium Regeneration*

8

## Input Materials

### Chlorination

189 kg CaO  
1870 kg CaCl<sub>2</sub>  
239 kg Cl<sub>2</sub>

### Electrowinning

2244 kg CaCl<sub>2</sub>

## Operating Conditions

T= 1000 K

### Electrowinning

I= 2250 A  
Time = 80.2 hrs

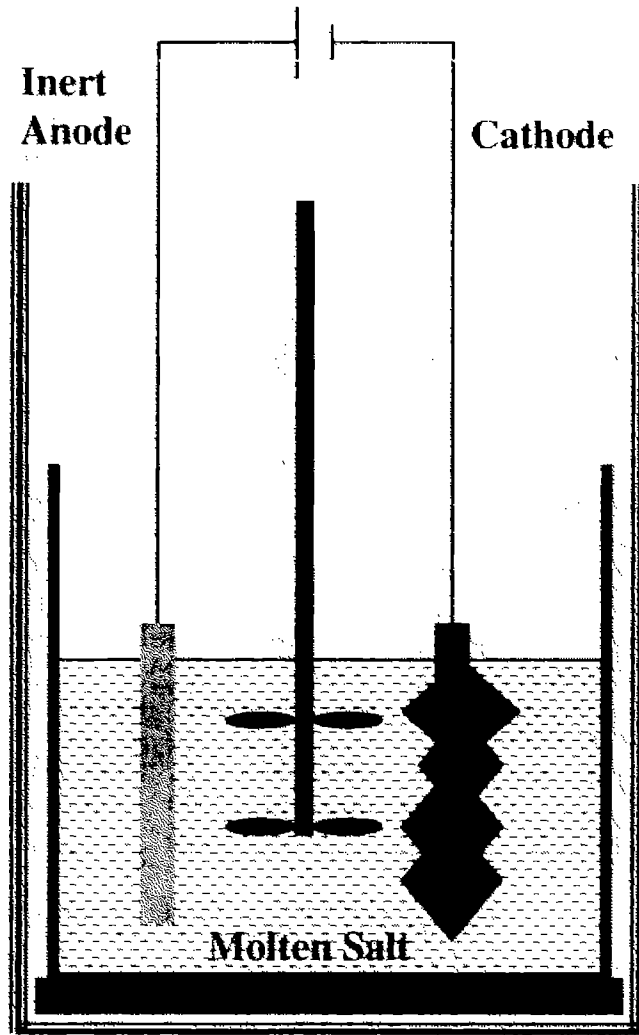

## Output Materials

### Chlorination

2244 kg CaCl<sub>2</sub>  
54 kg O<sub>2</sub>

### Electrowinning

recycle to #2  
1870 kg CaCl<sub>2</sub>  
135 kg Ca

239 kg Cl<sub>2</sub>

Treatment of four batches of DOR salt



# *Treatment of 70000 t of Spent Nuclear Fuel in 60 yrs Requires 2 t / day / Plant\**

## Process Plant Parameters

System	Batch (kg HM)	Process Time (hr)	Number of Systems	Capacity per day (kg HM)	Operating Parameters
Decladding	400	24	6	2400	
DOR	120	8	6	2160	
DOR Salt Recycle	121 (Ca)	20	6	726	8000 A (8 kW)
Electrorefinishing LWR fuel	400	17	5	2000	8000 A (8 kW)
Electrorefinishing Anode Polish	3	2	5	15	500 A (500 W)
Electrowinning U / TRU / RE	18	10	5	90	500 A (500 W)
Reductive Extraction	3.5	8	2	21	
Fuel Fabrication	5.4	12	5	27	
Offgas System	Xe and Kr cryodistillation and collection		1		

Two chemical plants are required to treat LV and ATW waste, 300 day/yr - 24 hr/day.

# ATW Waste Treatment Flow Chart

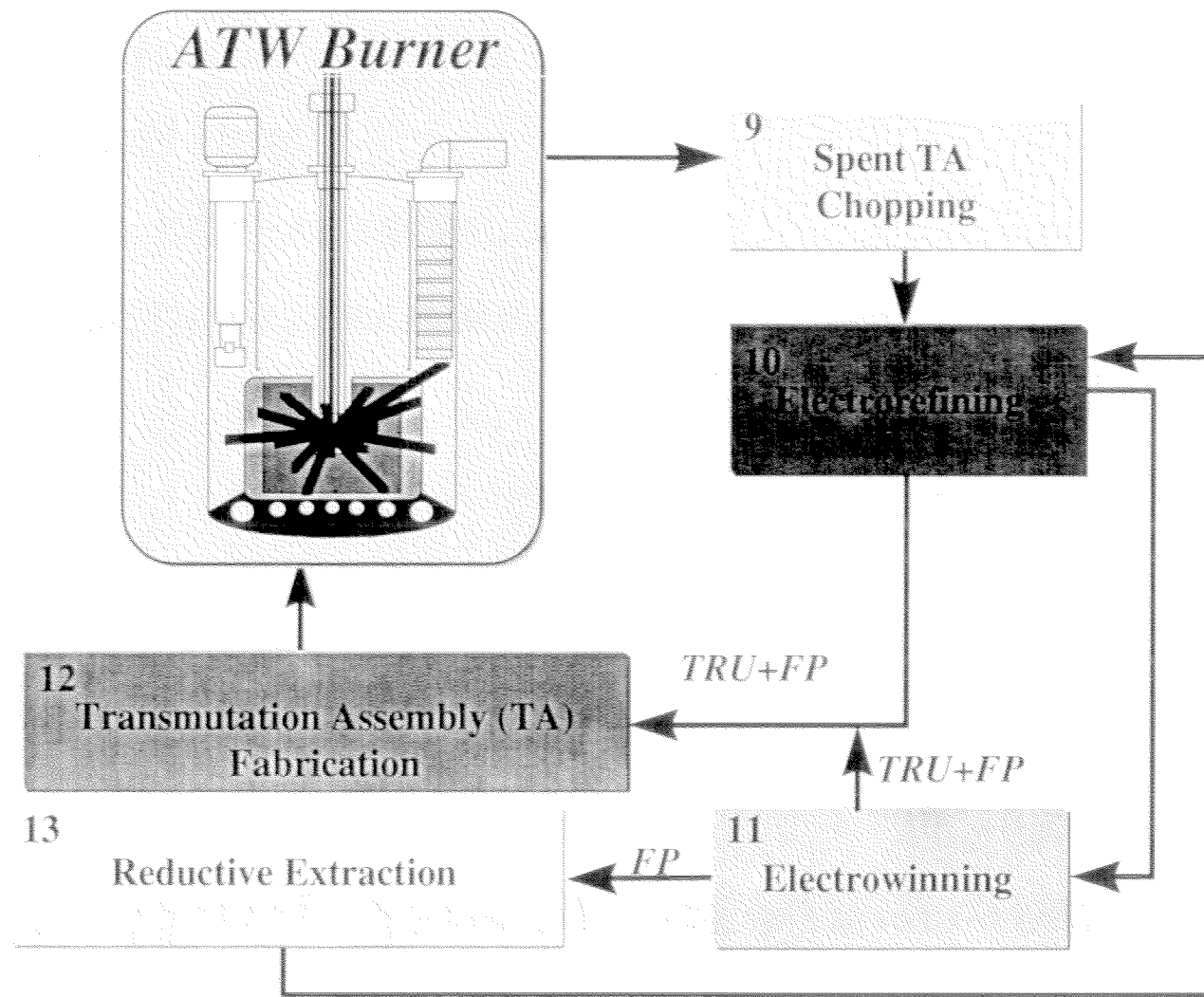

# *ATW Waste Treatment Simulation*

- **One ATW waste fuel assembly**
- **182 MW day/ kg average burn-up**
- **60 days cooling time**
- **Composition from ORIGEN calculations**

# *Chopping ATW Assembly Produces Feed Material for the Electrorefining Process*

---

**9**

- **Support hardware removed from assembly**
- **Spent ATW fuel chopped into small (~0.5 in) sections using traditional methods**
- **If no fuel / clad bonding material is used, cladding is sent to storage**
- **Offgas released by chopping is collected and stored**

# Electrorefining of ATW Assembly Provides U, TRU, and Fission Product Separation

10

## Input Materials

45 kg HM<sup>^</sup> from #9  
 9.45 kg TRU  
 2.25 kg U  
 450 g RE

1 kg Pu<sup>3+</sup>  
 18.8 kg NaCl-KCl

## Operating Conditions

I = 500 A  
 Time = 6.7 hrs  
 T = 1000 K

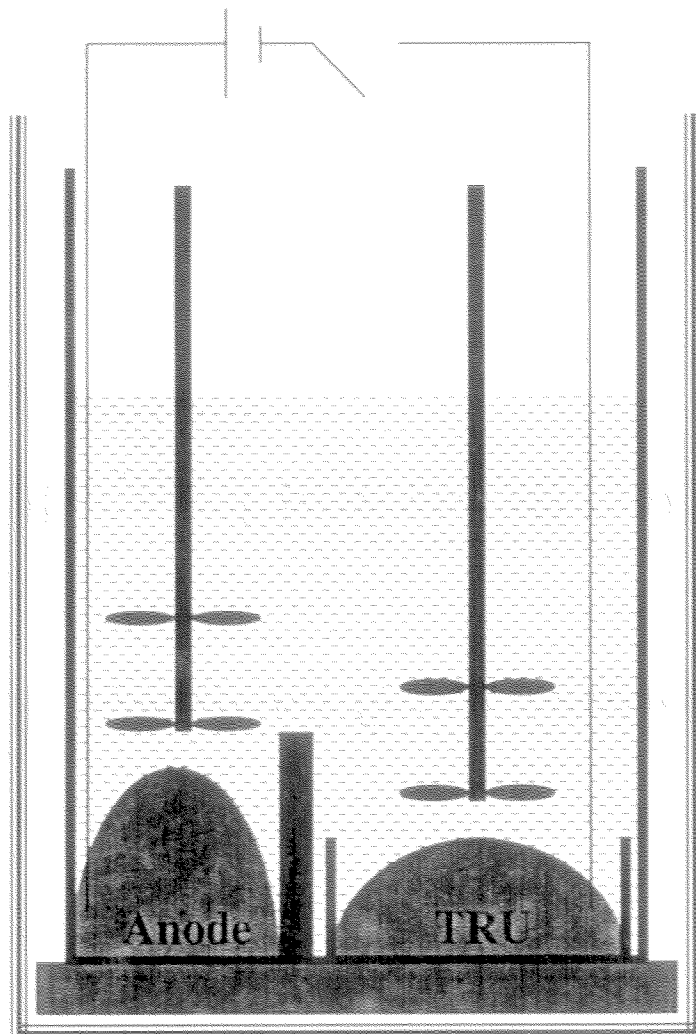

## Output Materials

### Anode

32.85 kg NM  
 2058 g U  
 0.099 g TRU  
 0.17 g RE

### Molten Salt to #11

172 g U  
 739 g TRU  
 50 g RE  
 18.8 kg NaCl-KCl

### Cathode to #12

20 g U  
 9710.9 g TRU  
 399.83 g RE

### Offgas

50 g Xe, Kr

One ATW fuel assembly

<sup>^</sup> Includes Zr ATW waste

# *Electrowinning TRU from Process Salt Allows for Salt Recycle*

11

## Input Materials

molten salt from #10

1720 g U

7390 g TRU

500 g RE

2852 g Na as alloy

188 kg NaCl-KCl

## Operating Conditions

I= 500 A

Time = 6.1 hrs U/TRU/RE

T= 1000 K

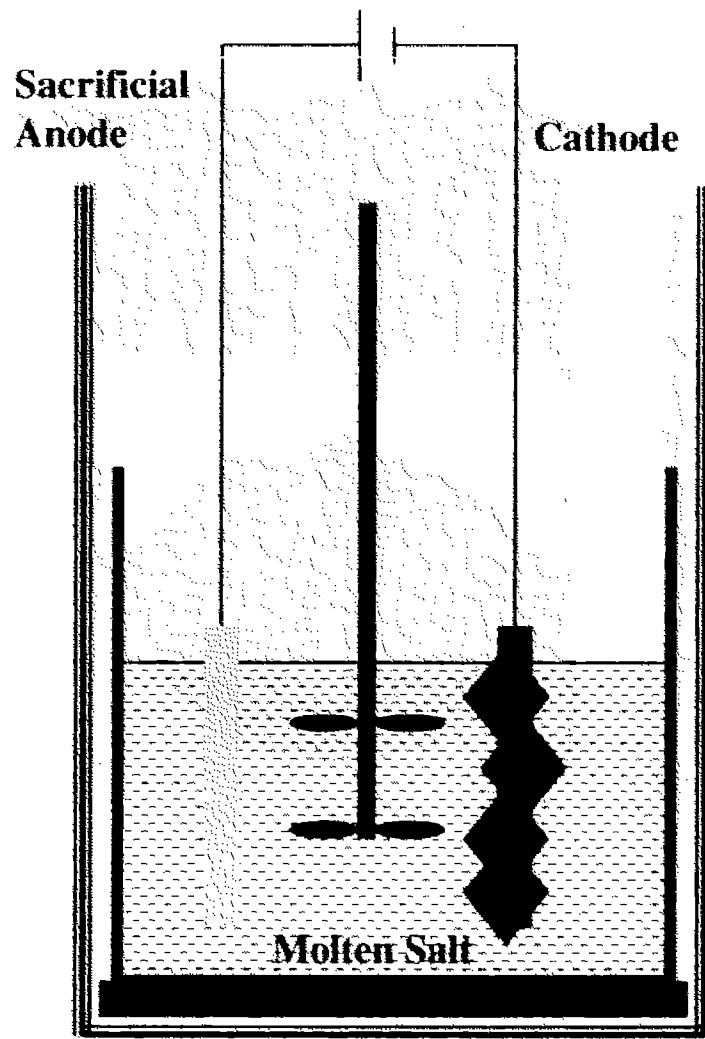

## Output Materials

### Molten Salt to #13

400 g RE

190.8 kg NaCl-KCl

### Cathode to #12

U/TRU/RE extraction

1720 g U

7390 g TRU

100 g RE

Molten Salt from 10 electrorefining systems

# Fuel Fabrication for ATW system

12

## Input Materials\*

from #10 and #11

1740 g U

17100 g TRU

500 RE

52290 g Zr from #1

## Operating Conditions

T = 1900 K

Moderate Vacuum

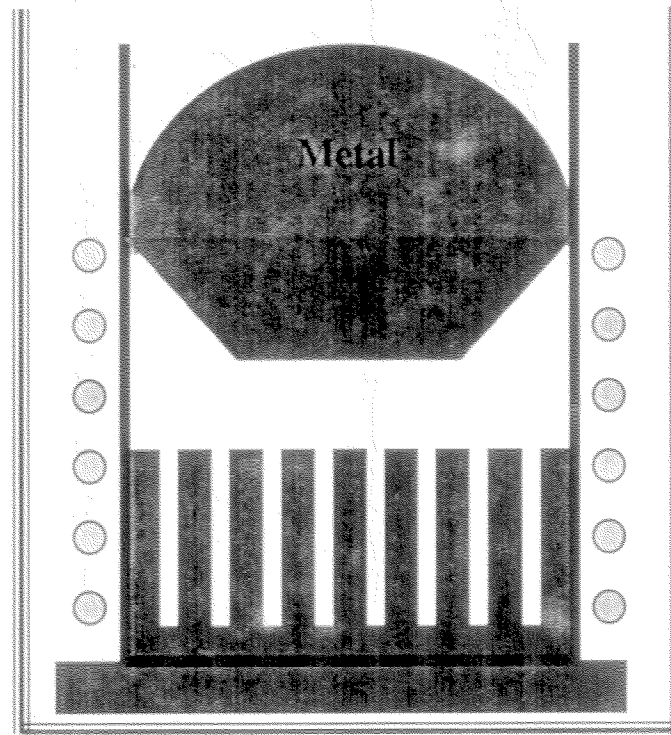

## Output Materials

71630 g alloy fuel

## Fuel Preparation

1. rods machined to proper diameter
2. rods cut into pellets for use in fuel pins

High Temperature Vacuum Casting Furnace

Four Batches required to prepare fuel alloy

\* Includes U / TRU / RE from electrowinning process #9

# *Reductive Extraction Process Removes Rare Earths from Process Salt*

13

## Input Materials

400 g RE from #11

197 g Na as alloy

188 kg NaCl-KCl

## Operating Conditions

Time = 8 hrs

T = 1000 K

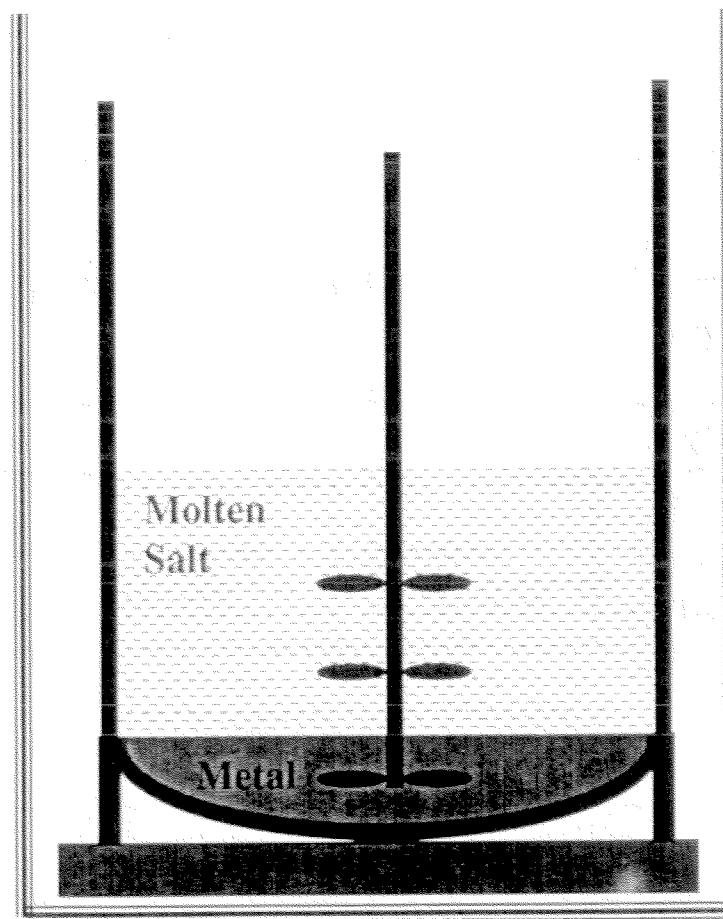

## Output Materials

### Molten Salt

188 kg NaCl-KCl

### Metal Phase

400 g RE



# *Treatment of ATW Waste Requires 360 kg / day / Plant\**

## Process Plant Parameters

System	Batch (kg HM)	Process Time (hr)	Number of Systems	Capacity per day (kg <sup>^</sup> )	Operating Parameters
Chopping	11.7	8	3	405	
Electrorefining	11.7	6.7	4	360	500 A (500 W)
Electrowinning	9.2	6.1	1	9.2	500 A (500 W)
Reductive Extraction	0.5	8	1	0.5	
Fuel Fabrication	4	6	5	100	
Offgas System	Xe and Kr cryodistillation and collection		1		

\*Two chemical plants are required to treat LWR and ATW waste. 175 day/yr - 24hr/day.

<sup>^</sup> Includes Zr in ATW waste

# *Projected TRU Waste Output to Repository*

---

- **Treatment of LWR spent fuel**
  - **simulations indicate 12 ppm TRU waste output with anode polishing**
- **Treatment of ATW spent fuel**
  - **simulations indicate 10 ppm TRU waste output**
- **Higher process loss may be present in engineering scale systems**
- **Total TRU sent to repository, 60 yrs operation: < 300 kg in approximately 900 t of NM**

# *ATW Provides Segregated Waste Streams for Disposal*

---

- **Uranium - low level waste, radioactivity of natural U**
- **Metals - repository**
  - **spent fuel clad and fuel assembly hardware**
- **Transition Metal Oxides - repository**
- **Lanthanide Oxides - repository**
- **Active Metals**
  - **engineered storage containers, repository**

# *Treatment of ATW Waste Offers Advantages over ALMR Fuel Reprocessing*

---

- **Less material to process, U is not present at significant levels**
  - **smaller batch size, 45 kg instead of 400 kg**
  - **moderate operating current, 500 A instead of 8000 A**
  - **possible reduced cost**
  
- **No deleterious effect of fission product carry-over into fresh fuel**

# *Process Chemistry Issues Addressed in 5 Year Program*

---

- **Develop process scalability information by designing, fabricating, and testing various size electrochemical cells, reduction systems, and reductive extraction systems**
- **Develop more detailed material balance for process chemistry**
- **Verification of separation efficiency for electrorefining and electrowinning processes at 10 kg scale**
- **Establish complete thermodynamic database, e.g., Cm and Np**
- **Verification of proposed ATW fuel preparation process at kg scale, provide fuel for irradiation experiments**
- **Verification of multicomponent reductive extraction process at 10 kg scale**

# *Technetium and ATW*

**Los Alamos National Laboratory**

**- ATW Project -**

**Presented by: Ann R. Schake**

**Nuclear Materials Technology Division**

## *In a Repository ...*

**...the high mobility in ground water and long-lived radiotoxicity makes accountability of technetium extremely important.**

# *Yucca Mountain Geology*

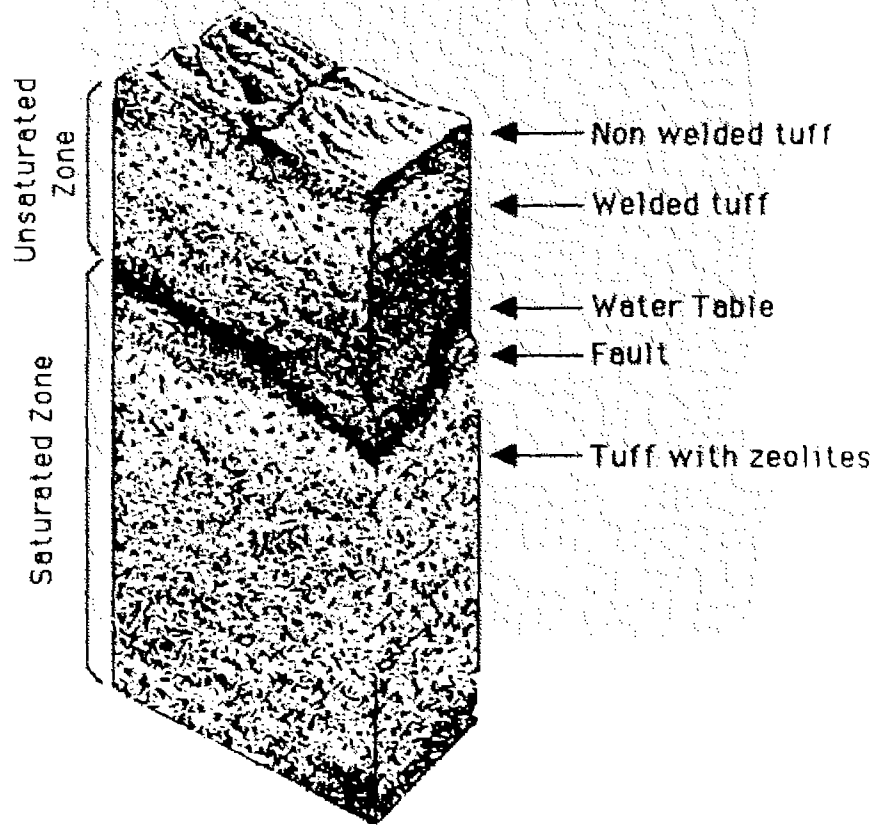

- **~2 km thick tuff (volcanic ash) layers**
- **highly fractured**
- **water table ~500 m below surface**
- **proposed repository in water-unsaturated zone**



# *Yucca Mountain Chemistry*

---



- **Mainly silicic rocks**
- **Neutral to Basic pH water (6.8 - 8.3)**
- **Water-unsaturated conditions (fairly arid)**
- **Oxidizing environment**

# *Tc Mobility is a Concern for a Repository*

---

- **Tc and  $\text{TcO}_2$  are easily oxidized to  $\text{Tc}_2\text{O}_7$  and subsequently  $\text{TcO}_4^-$** 
  - **$\text{TcO}_4^-$  is extremely mobile in the environment**
- **Reducing conditions are needed to maintain  $\text{TcO}_2$** 
  - **Expect oxidizing conditions at Yucca Mountain**
  - **In POLLUX containers a large excess of Fe is needed to retain reducing conditions (Fe:Tc = 14700:1)**
  - **Even under reducing conditions radiolysis forms  $\text{Tc}^{\text{VII}}$**
- **Tc release rate is 1-2 orders of magnitude greater than that for Cs and Sr**
- **$^{99}\text{Tc}$  half-life is more than four orders of magnitude greater than  $^{137}\text{Cs}$  and  $^{90}\text{Sr}$**

# *ATW Provides a Solution to the Concerns Posed by Tc*

---

- **Tc exists as an alloyed metal in spent fuel.**
  - **Tc metal can be recovered and made into targets**
  - **70000t inventory contains about 5.3 t of Tc**
- **Tc is transmuted to Ru by neutron capture in ATW**
- **Tc is transmuted in either fast or thermal spectrum  
ATW system**

# *Technetium is Isolated in the Anode of the Electrorefining Process*

---

## **Tc Recovery**

- **Oxidation of Tc, and anode metals, forming  $Tc_2O_7$** 
  - **Other metals will also be oxidized, e.g. Zr, Mo, Ru**
- **Distill and condense  $Tc_2O_7$** 
  - **Tc forms the most volatile metal oxide of those present**
- **Direct oxide reduction to recover Tc**
- **Alloy Tc with Mo**
  - **Mo is a good host for Tc, ~10 atom percent solubility of Tc in Mo**

# *Thermodynamic Properties of Tc and Related compounds*

Species	Melting Point (K)	Boiling Point (K)	Vapor Pressure (torr)	
			300 K	500 K
Tc	2445	4850		
Mo	2890	4885		
Ru	2583	4173		
TcO <sub>2</sub> *	(dec. 1173K)		3.45e-11	7.26e-5
Tc <sub>2</sub> O <sub>7</sub>	392	583	1.26e-3	72.4
MoO <sub>3</sub>	1073	1428	2.72e-34	7.08e-15
Re <sub>2</sub> O <sub>7</sub>	570	635	6.02e-10	2.54

\*Thermodynamic data shown is for ReO<sub>2</sub>.

# *Experiments Planned for the Five Year Program*

---

- **Separation experiments on Re / Mo and Mo / Tc oxides and alloys**
  - bench-scale tests using Re as a Tc surrogate
  - distillation experiments
  - DOR experiments
  - alloy studies
- **Non-aqueous oxidation potential for Mo, Re, and Tc**
  - important for ER process

# *Summary*

---

*Recovery and transmutation of Tc in ATW reduces the uncertainty associated with Tc management.*

- **Chemistry of Tc in a repository environment is established**
- **Process chemistry is established for the recovery of Tc**
  - **Oxidation, distillation/condensation, oxide reduction**
- **Tc is transmuted in either fast or thermal spectrum in ATW system**

# *Conclusions*

---

**Pyrochemical processing provides the link between spent fuel clean-up and the TRU burning in the ATW system.**

- **Process chemistry builds on existing experience**
- **Spent fuel treatment flow chart established**
- **Simulations indicate processes are viable and produce minimal TRU discharge**
- **Minimal secondary waste produced**
- **Main process chemistry issues identified**



# **Accelerator Design for ATW**

---

***George Lawrence***

***Project Leader for APT Accelerator Design  
Los Alamos National Laboratory***

**Presentation at  
ATW Technical Review**

**Massachusetts Institute of Technology  
January 15-16, 1998**

# Outline

---

- **Accelerator design basis**
- **Proposed ATW linac design**
- **Relation to APT**
- **Technical issues and ED&D program**

# Design Objectives for ATW Accelerator

---

**A linac for an ATW facility should be designed:**

- To have very high electrical efficiency (ac to beam power)
- For minimum capital and operating costs
- For minimum spatial footprint (short length)
- To vary the power on target over a wide range
- To have high availability and operational flexibility
- To use the best mix of established technology and anticipated technology advances.

**Nominal beam parameters**

- 40 MW proton beam
- 1000 MeV, 40 mA, 100% duty

# Neutron Production on Spallation Targets as a Function of Proton Energy

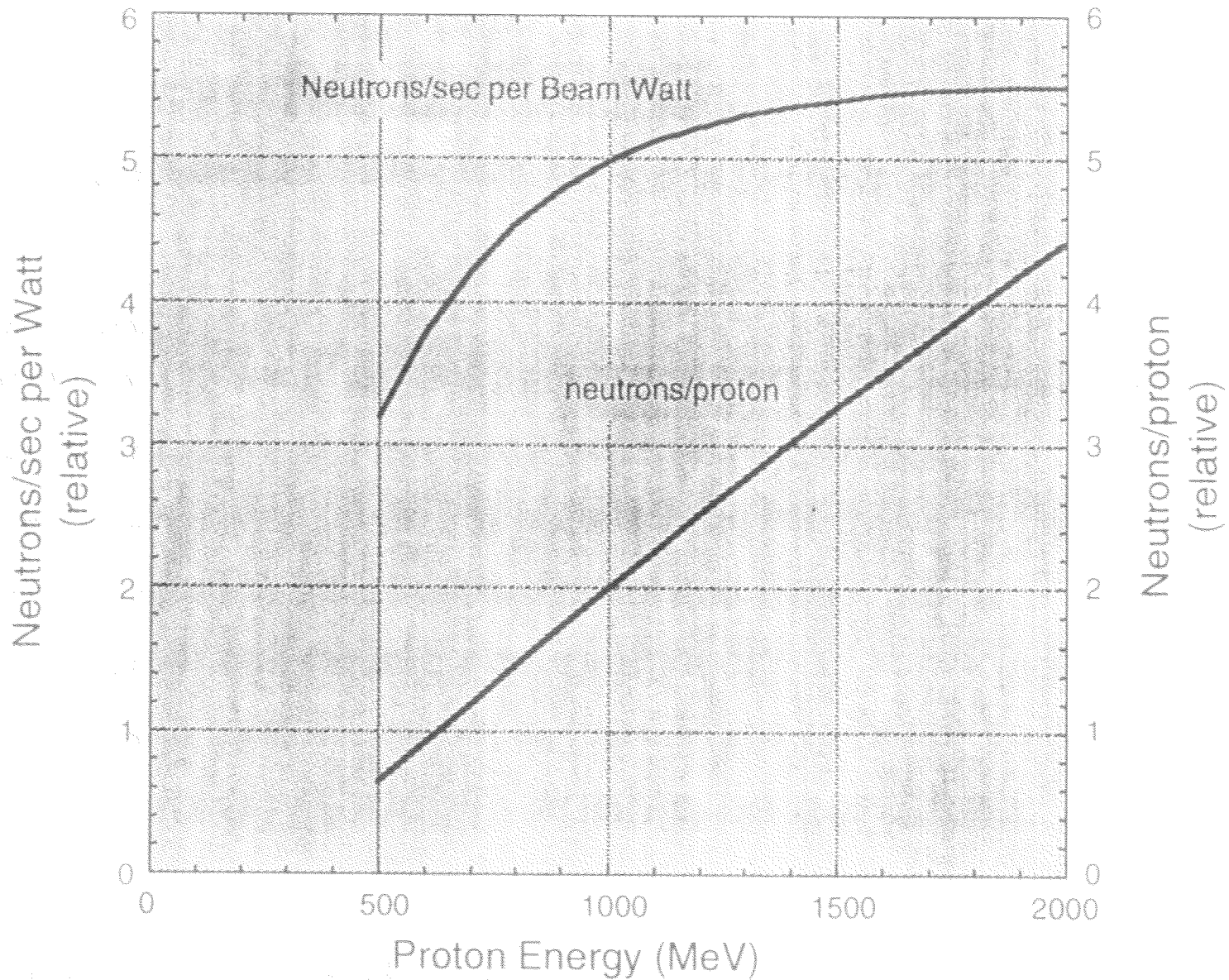

# High-Gradient $\text{S/C}$ Linac for ATW

Normal-Conducting

Superconducting

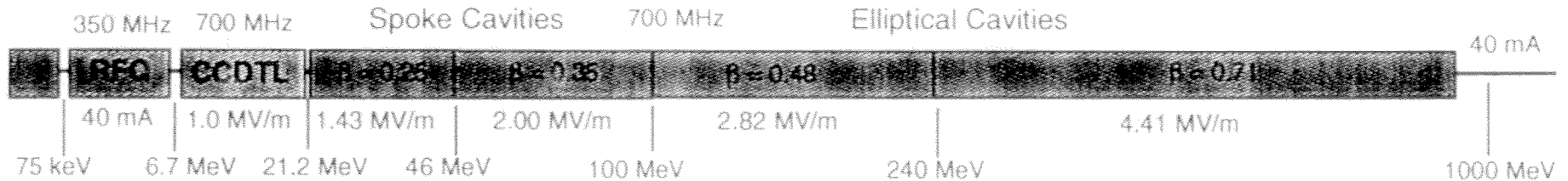

Singlet (FODO) focusing lattice

Proton energy	1000 MeV
CW beam current	40 mA
Beam power	40 MW
Total RF power	42.3 MW
Linac AC power	95 MW
Peak coupler power	200 kW
Cryomodules	2/3/7/19
Klystrons (1-MW)	56
Linac length	355 m
Aperture radius	1/3/4/5/7.5 cm
Cryoplant load (2K)	15 kW

# High- $\beta$ Superconducting Linac Architecture ( $\beta = 0.71$ )

## Singlet Lattice, 4 Cavities per Cryomodule

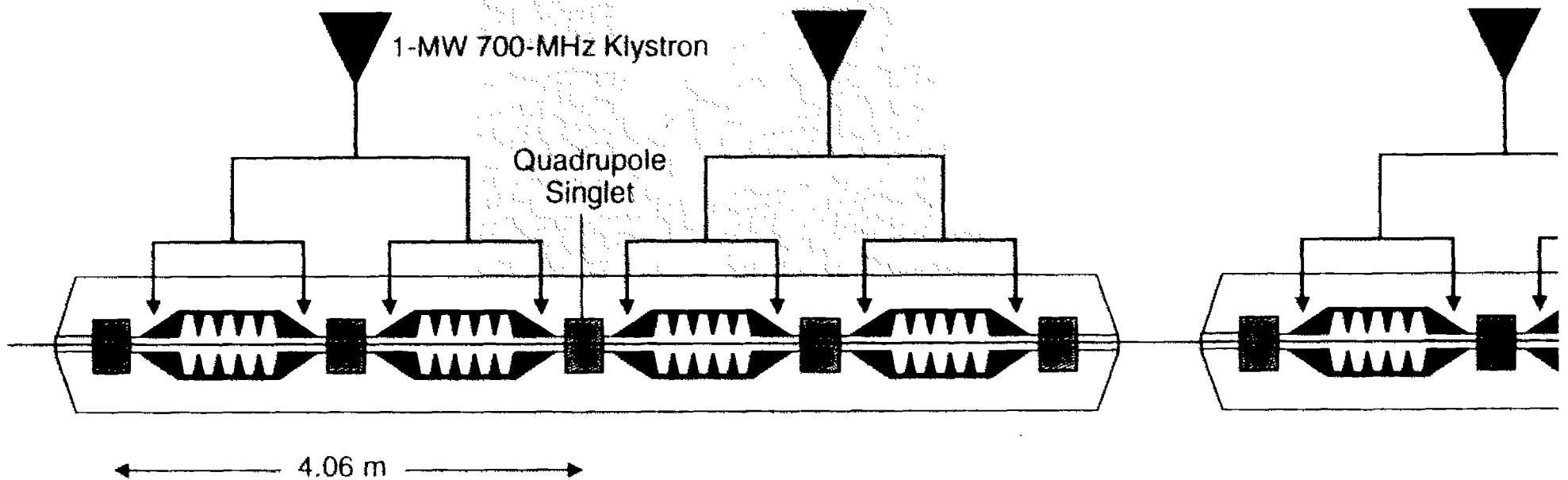

Energy span	240 - 1000 MeV
$E_{\text{accelerating}}$	15.2 MV/m
$E_{\text{average}}$	4.41 MV/m
5-cell cavities	76
Cryomodules	19

Section length	199.5 m
Klystrons	38
Power/coupler	200 kW
Power/klystron	800 kW
SC quadrupoles	95

# Global Accelerator Parameters

Parameter	Value
Output proton current	40 mA
Duty factor	100%
Final energy of NC linac (MeV)	21.2
Final energy of SC linac (MeV)	1000
Length (m)	345
RF power (MW)	44.6
Number of klystrons	3 at 350 MHz; 53 at 700 MHz
Number of cryomodules	31
Number of NC accelerating cavities	106 x 2
Number of SC accelerating cavities	134
Number of NC quadrupoles	105 x 2
Number of SC quadrupoles	165

## NC Linac Parameters

Parameter	RFQ	CCDTL
Structure gradient (MV/m)	1.38	2.04 - 1.86
Average gradient (MV/m)	1.38	0.77 - 1.03
Length (m)	8.0	29.6
Synchronous phase (deg)	-30	-30
Quadrupole lattice period	$\beta\lambda$	8 - 9 $\beta\lambda$
Number of quadrupoles	-	105 x 2
Focusing lattice	-	singlet FODO
Aperture radius (cm)	0.23 - 0.34	1.0
Copper RF power loss (MW)	1.26 x 2	1.02 x 2
Beam power (MW)	0.26	0.58
Total RF power (MW)	2.8	2.6
Number of klystrons	3 x 2	3 x 2
Energy range (MeV)	0.075 - 6.7	6.7 - 21.2
Number of accelerating cavities	4 x 2	105 x 2
Frequency (MHz)	350	700



# Superconducting Linac Parameters

Parameter	$\beta = 0.25$	$\beta = 0.35$	$\beta = 0.48$	$\beta = 0.71$
Initial energy (MeV)	21.2	46	100	240
Final energy (MeV)	46	100	240	1000
Structure gradient (MV/m)	8.6	9.3	11.2	15.2
Active accelerating fraction	0.166	0.215	0.252	0.290
Average gradient (MV/m)	1.43	2.00	2.82	4.41
Energy gain per cavity (MeV)	2.0	3.0	5.0	10.0
Synchronous phase (deg)	-30	-30	-30	-30
RF power per cavity (kW)	80	120	200	400
RF power per section (MW)	1.0	2.2	5.6	30.4
RF coupler power (kW)	80	120	200	200
Cavities per cryomodule	6	6	4	4
Klystrons per cryomodule	1	1	1	2
Number of cavities	12	18	28	76
Number of cryomodules	2	3	7	19
Number of klystrons	2	3	7	38
Number of SC quadrupoles	14	21	35	95
Quadrupole length (cm)	28	28	28	40
Number of couplers per cavity	1	1	1	2
Focusing lattice	FODO	FODO	FODO	FODO
Cryomodule period (m)	9.7	10.4	8.2	10.5
Section length (m)	19.4	31.2	57.4	199.5
Aperture radius (cm)	3	4	5	7.5
Frequency (MHz)	700	700	700	700

# Integrated SC/NC Linac Provides Optimum Performance by Exploiting Advantages of Each Technology

---

- **NC linac for low energies**

- high-density magnetic focusing lattice
- smoothly varying accelerating and focusing parameters
- excellent emittance control of high-current beam
- minimal generation of beam halo

- **SC linac for high energies**

- eliminating cavity RF losses provides very high power efficiency
- very large aperture dramatically reduces beam loss threat
- short cavities provide wide velocity acceptance bandwidth
- gradient adjustability and independent RF phasing allow flexibility to meet beam-power needs by energy/current tradeoff
- large apertures plus retunability provide increased tolerance to a wide range of error and fault conditions

# **ATW Linac Design is Based on APT Design and Technology**

---

- **Developed integrated high-power 1700-MeV, 100-mA linac design.**
- **Issued Conceptual Design Report and Cost Estimate (confirmed by ICE).**
- **Linac design and ED&D program reviewed by high-level technical panels.**
- **Highlights**
  - **Linac architecture emphasizes large apertures and smooth variation of parameters for very low beam loss.**
  - **High-current, high-reliability proton injector in operation.**
  - **High-energy 100-mA 350-MHz RFQ designed and being fabricated.**
  - **Designed and modeled CCDTL as solution for low-energy region.**
  - **Designed multicell elliptical cavities and cryomodules for SC linac.**
  - **Tested single-cell niobium SC cavities for medium-beta (0.48, 0.64).**
  - **Developed 700-MHz 1-MW CW high-efficiency klystrons.**
  - **Worked out control approach for coupled beam/cavity/RF-drive.**
  - **Designed BOP systems for support of high-power linac.**

# Integrated SC/NC Linac Design for APT Plant

(New Baseline, 10/97)

## 3-kg/yr Production Rate

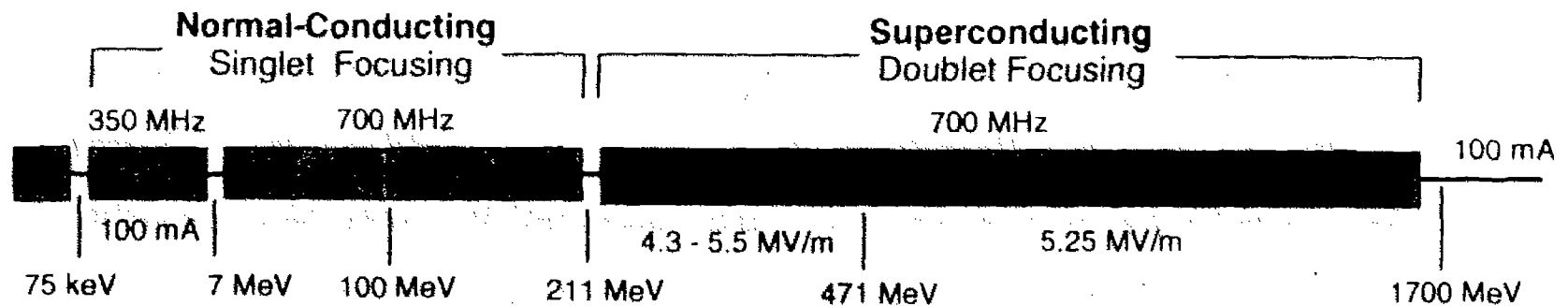

High-efficiency operation over wide range of beam power and tritium production requirements.

Proton energy	1700 MeV
CW beam current	100 mA
Beam power	170 MW
Plant AC power	470 MW
Peak coupler power	210 kW
Cryomodules	51/77
Klystrons (1-MW)	239
Linac length	1120 m
Cryoplant load (2K)	11.2 kW

10/18/97

**APT**

# High-Level Technical Reviews Have Confirmed APT Linac Design

---

- **JASONS have reviewed APT linac design several times as it has evolved (1988, 1992, 1995, 1997).**
- **1997 JASON Review endorsed SC high-energy linac design proposed as replacement for high-energy NC linac.**
- **Comprehensive review of APT system design undertaken by LLNL (11/94); stimulated study of SC high-energy linac option.**
- **MIT Review examined APT linac design when NC high-energy linac was the baseline (10/94).**
- **APT External Review Committee has provided overall technical critique and guidance for design evolution.**

# Linac Beam Simulation from 6.7 to 1700 MeV No Machine Errors Included

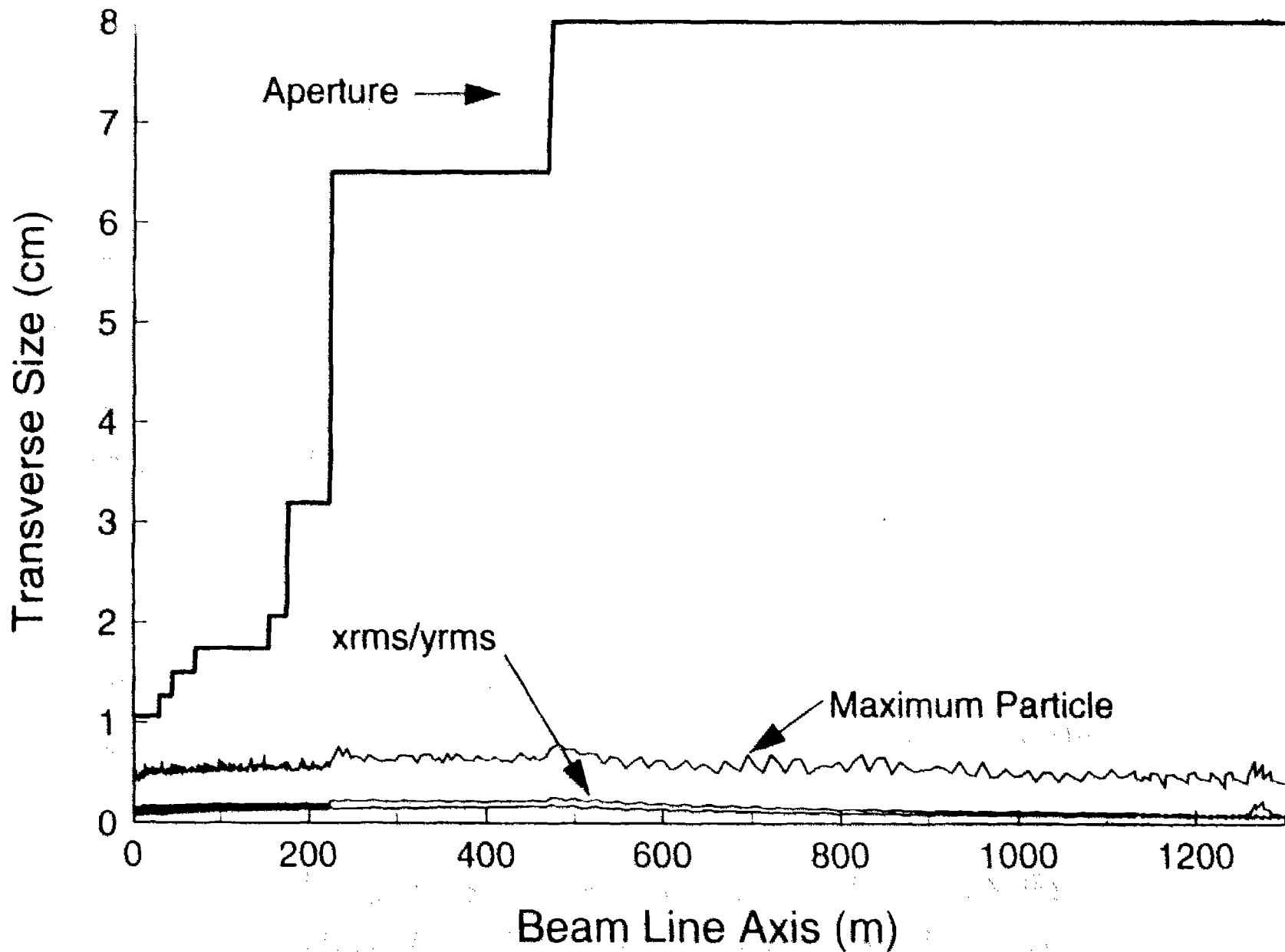

# Linac Beam Simulation from 6.7 to 1700 MeV Standard Machine Errors Included

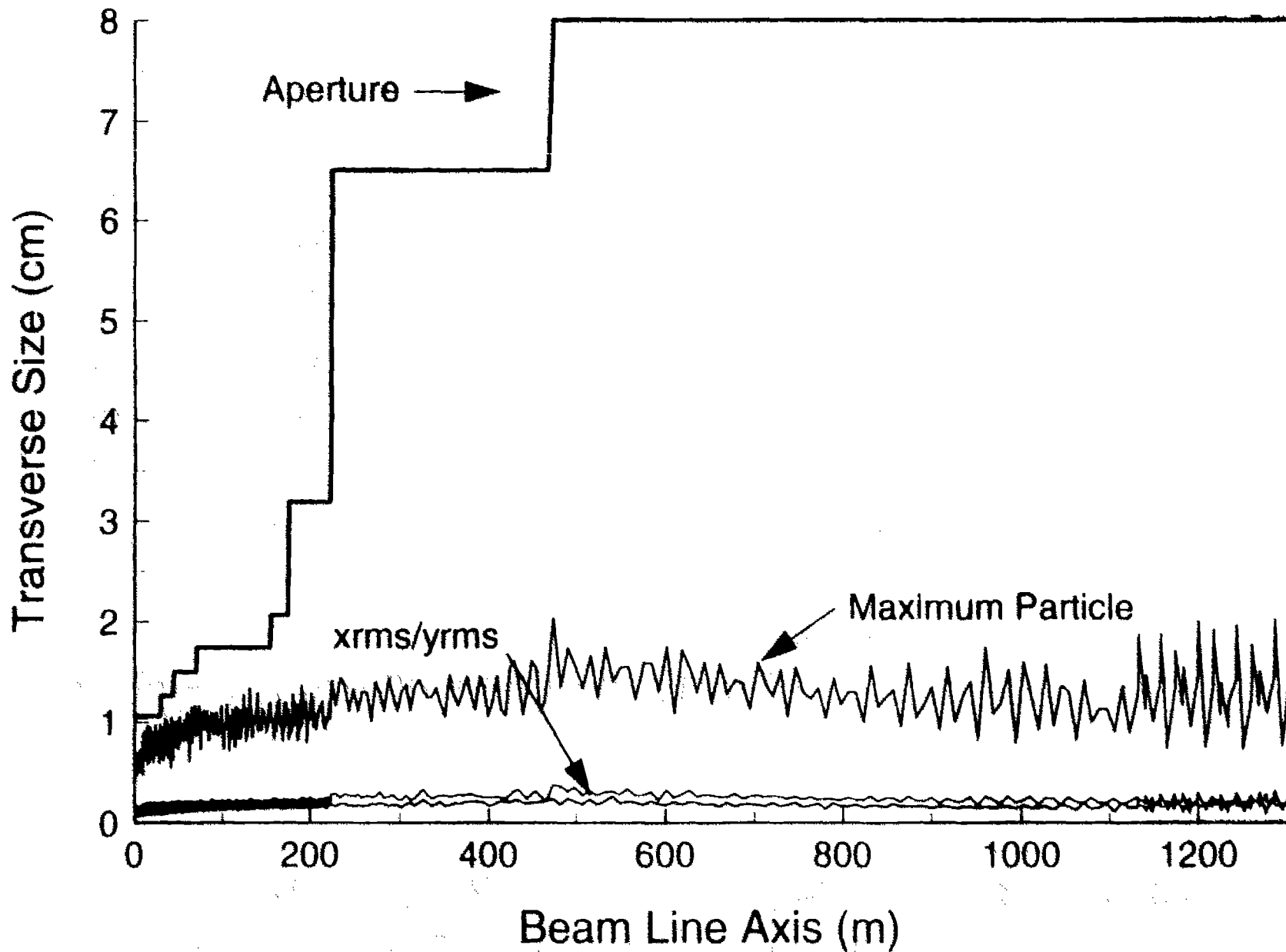

# ATW Linac Design is More Advanced than APT; Provides Efficiency and Cost Advantages

---

- **Higher accelerating gradient in SC linac**
  - much shorter linac; reduces length and costs
  - 15 MV/m for ATW vs 5 MV/m for APT
  - gradients achieved in TESLA cavity tests
- **Cryomodules contain SC quadrupoles in FODO lattice**
  - stronger focusing; larger aperture/beam-size ratio
  - higher electrical efficiency; minimizes quadrupole power
- **SC linac starts at lower energy**
  - 20 MeV instead of 210 MeV
  - reduces RF losses in low-energy linac; increases efficiency
  - increases aperture size at low energies
  - makes use of 1/2-wave (spoke-type) SC resonators



# The LEDA Injector has Demonstrated APT Beam Performance Requirements and Reliability

---

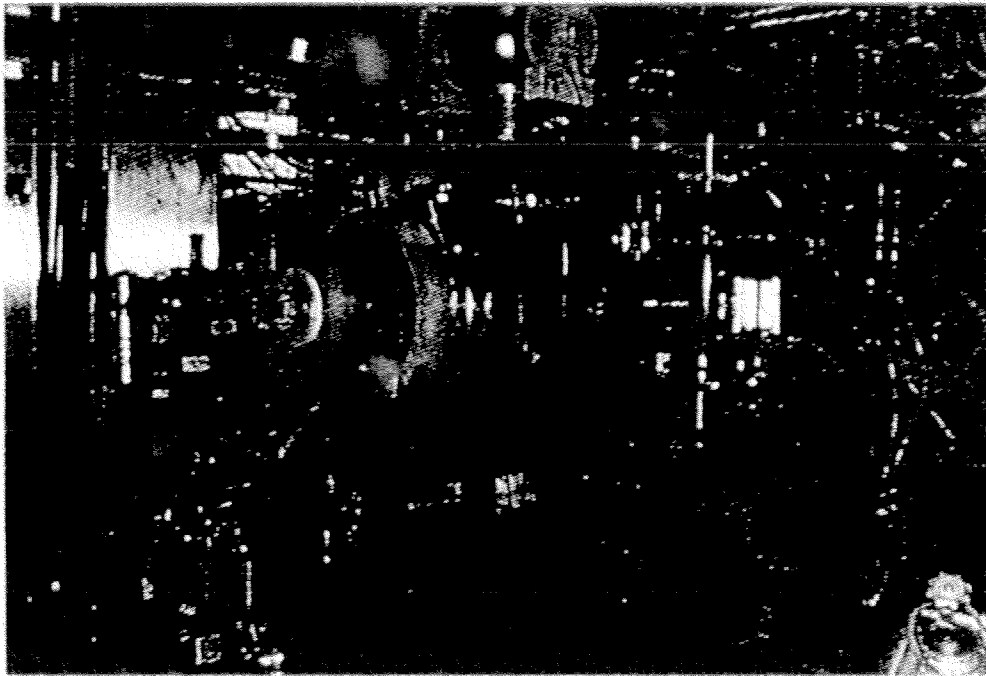

- H<sup>+</sup> current: 110 mA
- Energy: 75 keV
- H<sup>+</sup> fraction: 90%
- Arc power: 600 - 800W
- H<sub>2</sub> gas flow: 2 - 5 sccm
- Availability: 96 - 98%
- Emittance: 0.20  $\pi$  mm-mrad  
(rms normalized)

## 6.7-MeV, 8-m-Long RFQ is Made up of Four Resonantly-Coupled Segments

---

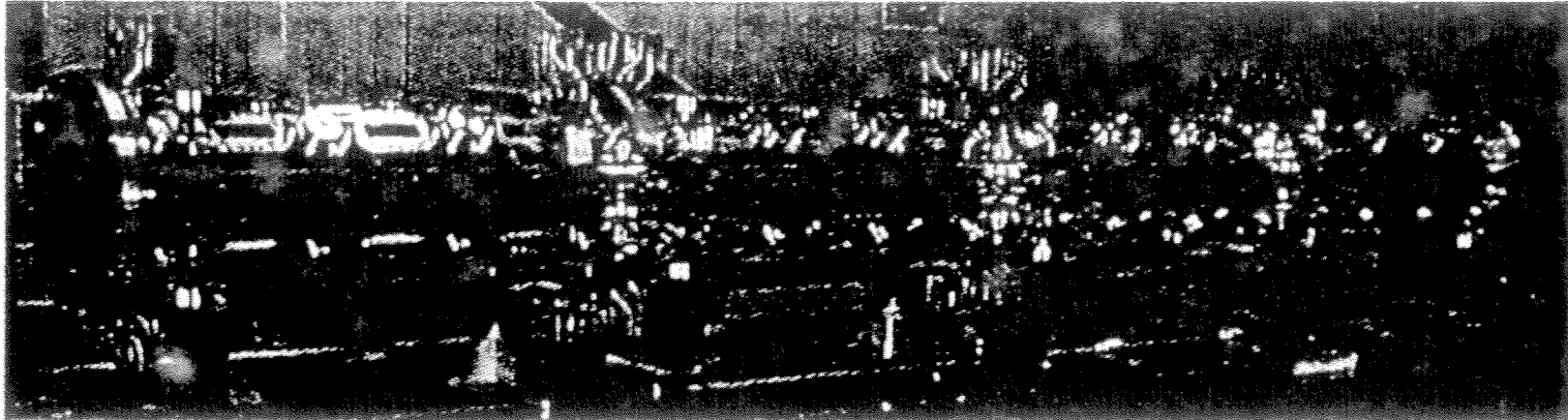

Two LEDA RFQ segments are coupled for measurement of RF power distribution, confirming details of fabrication.

One of 8 brazed RFQ sections, showing vanes, vacuum ports, & cooling lines.

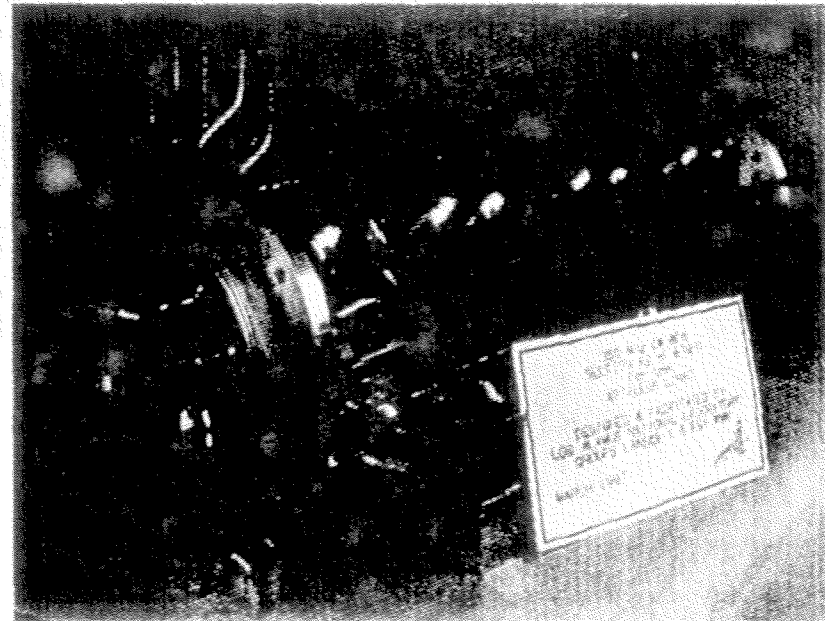

RFQ COMPONENTS

# As in APT Design, CCDTL Accelerating Structures will be Used in the Energy Range from 7 MeV to 21 MeV.

350MHz RFQ

2-gap CCDTL, 1 cavity/segment

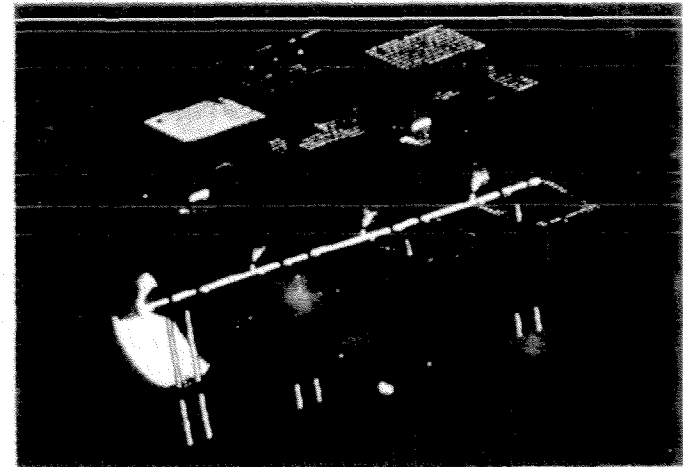
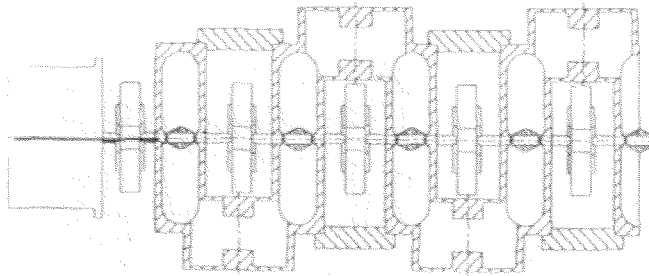

APT LINAC: CCDTL

TYPE TRANSITION @ 20MeV

3-gap CCDTL, 1 cavity/segment

2-gap CCDTL, 2 cavities/segment

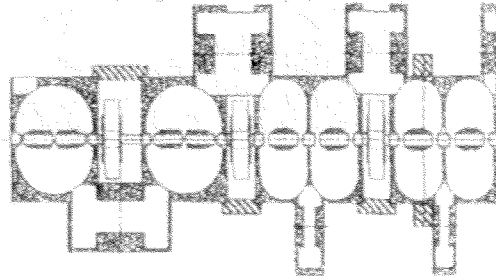

- Short DTLs, resonantly coupled.
- Combines best features of DTL and SCL.
- Strong RF coupling; field stability.
- Separation of acceleration and focusing.
- Ease of fabrication and assembly.
- Quadrupoles external to RF structure.

# Spoke-Type SC Resonators Have Been Developed for Acceleration in the Low Beta Region

---

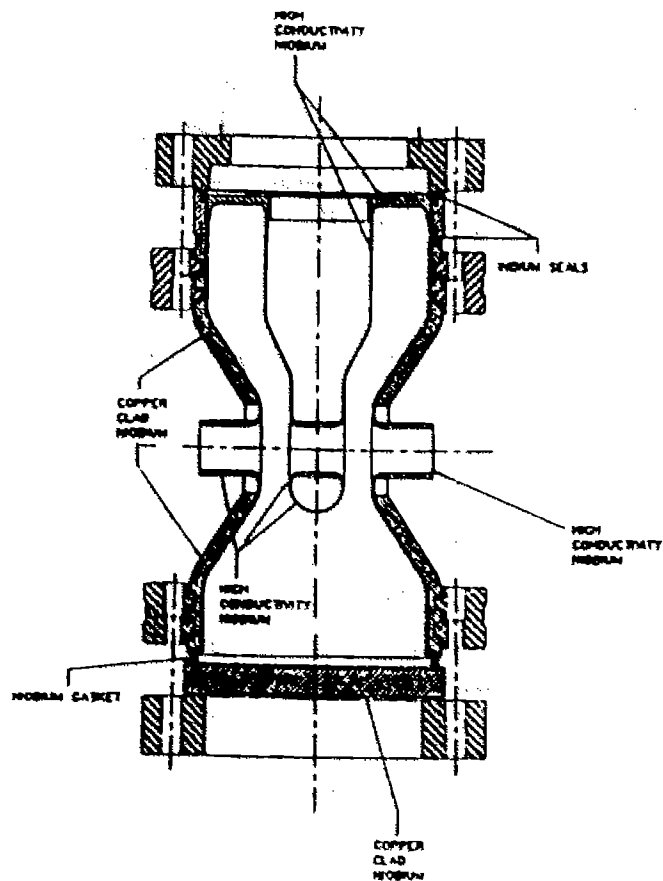

2-gap 1/4-wave resonator  
(400 MHz,  $\beta = 0.15$ )

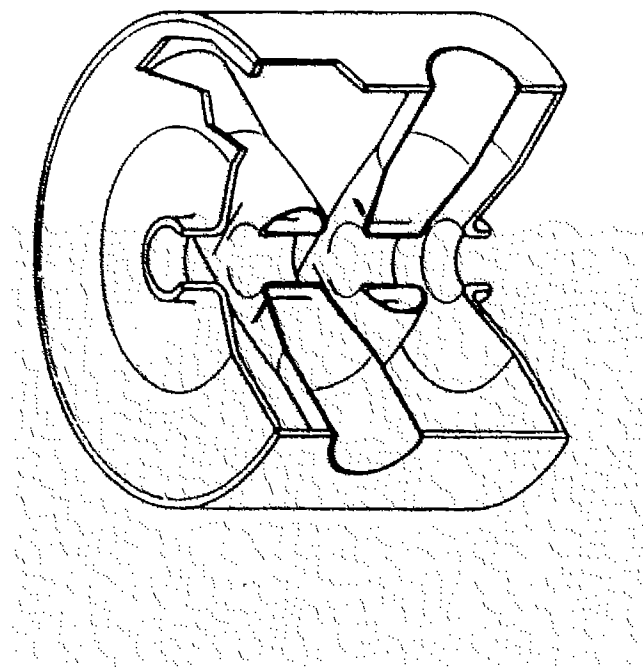

3-gap 1/2-wave resonator  
(850 MHz,  $\beta = 0.28$ )

# BETA = 0.64 5-Cell Niobium Test Cavity

---

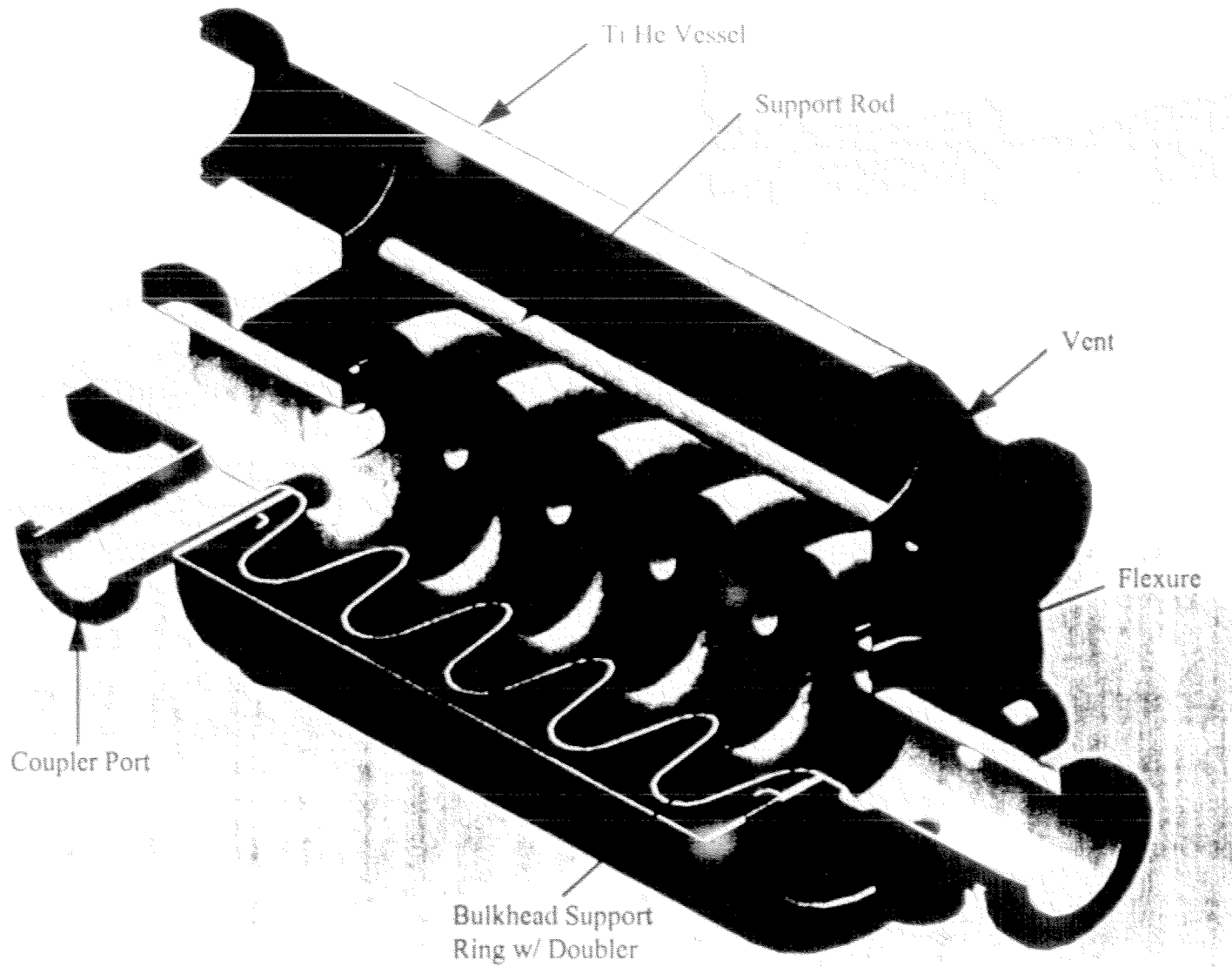

# RF Power System is Major Design Driver in Terms of Costs, Operability, and Availability

## RF Module in High-Beta SC Linac

- **RF power dominates accelerator construction and operating costs.**
  - use largest-size RF generators
  - make full use of klystron output power capability
  - choose largest practical value for RF power couplers
- **Power splitting architecture impacts RF control, tunnel geometry, and linac availability.**

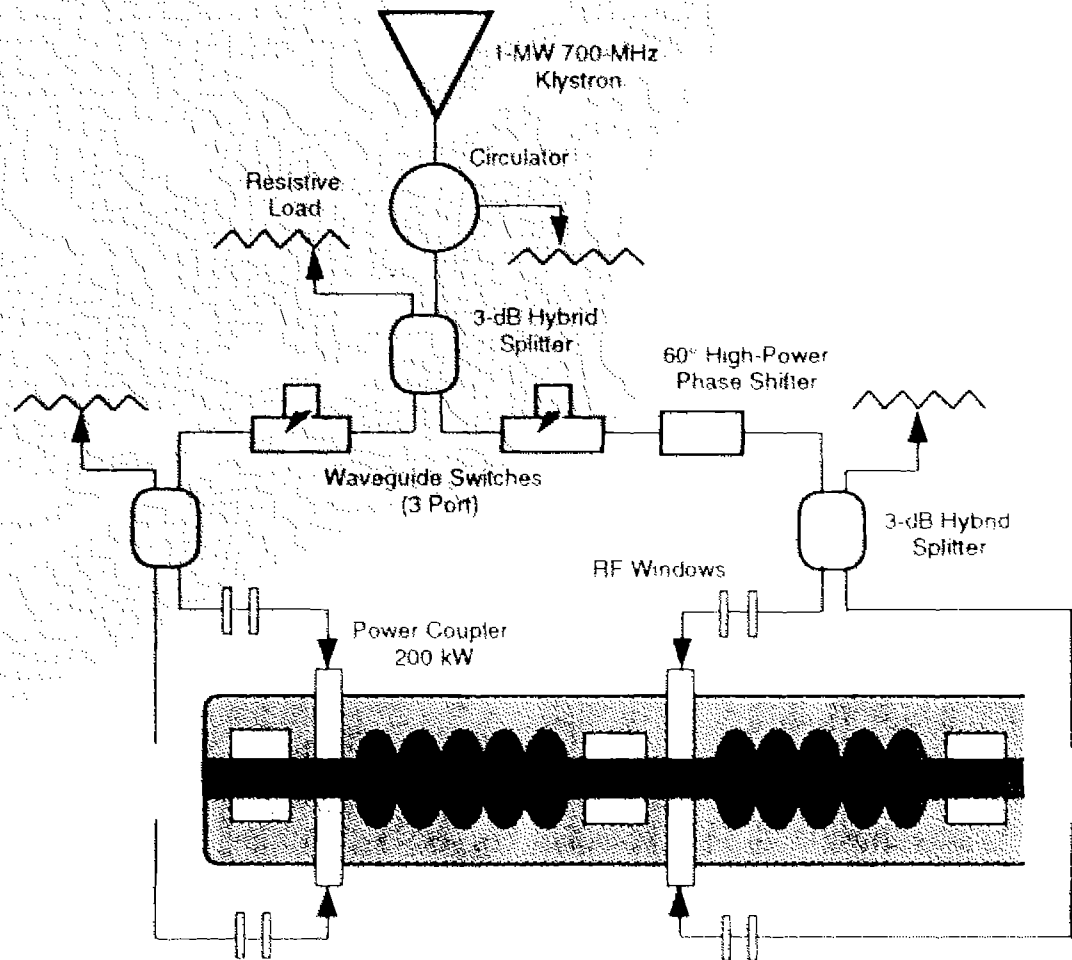

# APT Linac Engineering Development and Demonstration

---

- **Low-Energy Demonstration Accelerator (LEDA)** will address beam performance and integration/operation/availability issues for linac front end.
- **Power test of 100-MeV CCDTL/CCL segments** will confirm CW cooling and operation of NC linac sections with highest heat deposition.
- **SC cavity and cryomodule prototyping.** Three-stage program will confirm SC cavity and cryomodule designs and operability.
- **Advanced RF tube development.** Prototypes of advanced RF generators (klystrons, HOM IOTs) will enable higher electrical efficiency for plant.
- **High power RF window development.** Objective is to develop reliable 1-MW CW windows that have “infinite” life at 210 kW (nominal operation).
- **Advanced HVDC power supply development** has potential for significant cost savings.

# Purpose and Functions of LEDA (Low Energy Demonstration Accelerator)

---

Characterize:      Beam properties      Component lifetimes  
                         Operational reliability      Time to repair/replace  
                         Failure mechanisms

---

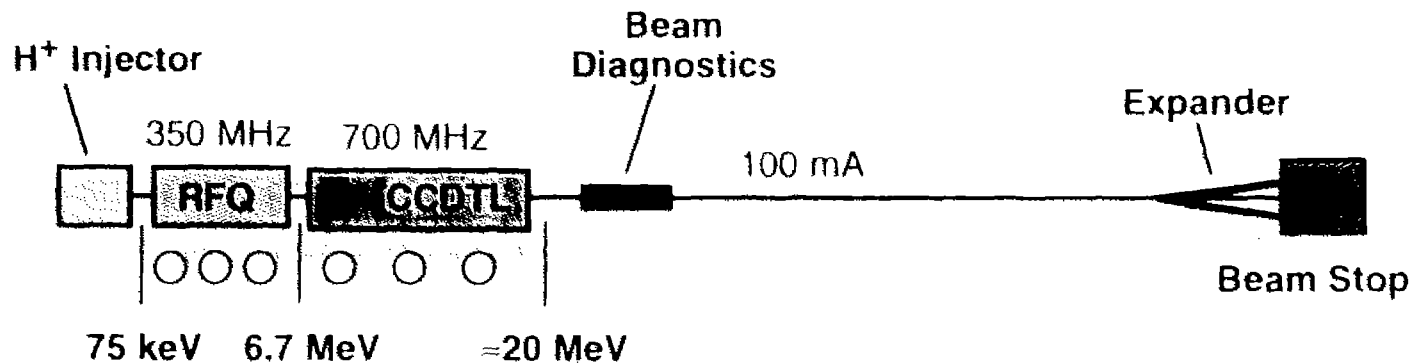

Demonstrate integrated full-power operation of APT low-energy linac.  
Refine equipment designs for plant.

Qualify vendors  
Improve cost estimates



# Single-Cell $\beta = 0.48$ Cavity Measurements Indicate that ATW Design Performance is Attainable

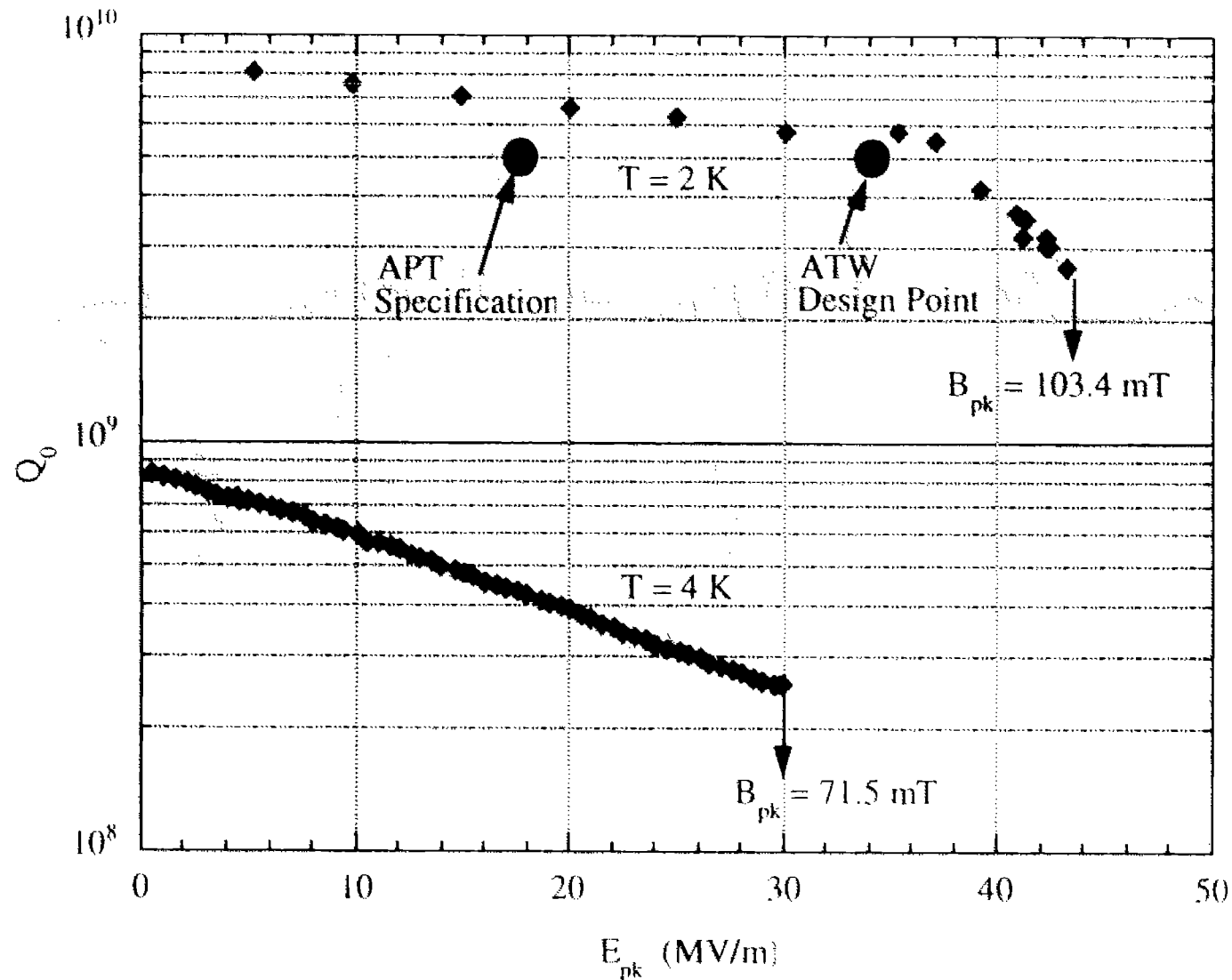

# SCRF ED&D Program Will Build Prototype Cryomodules for APT Linac

---

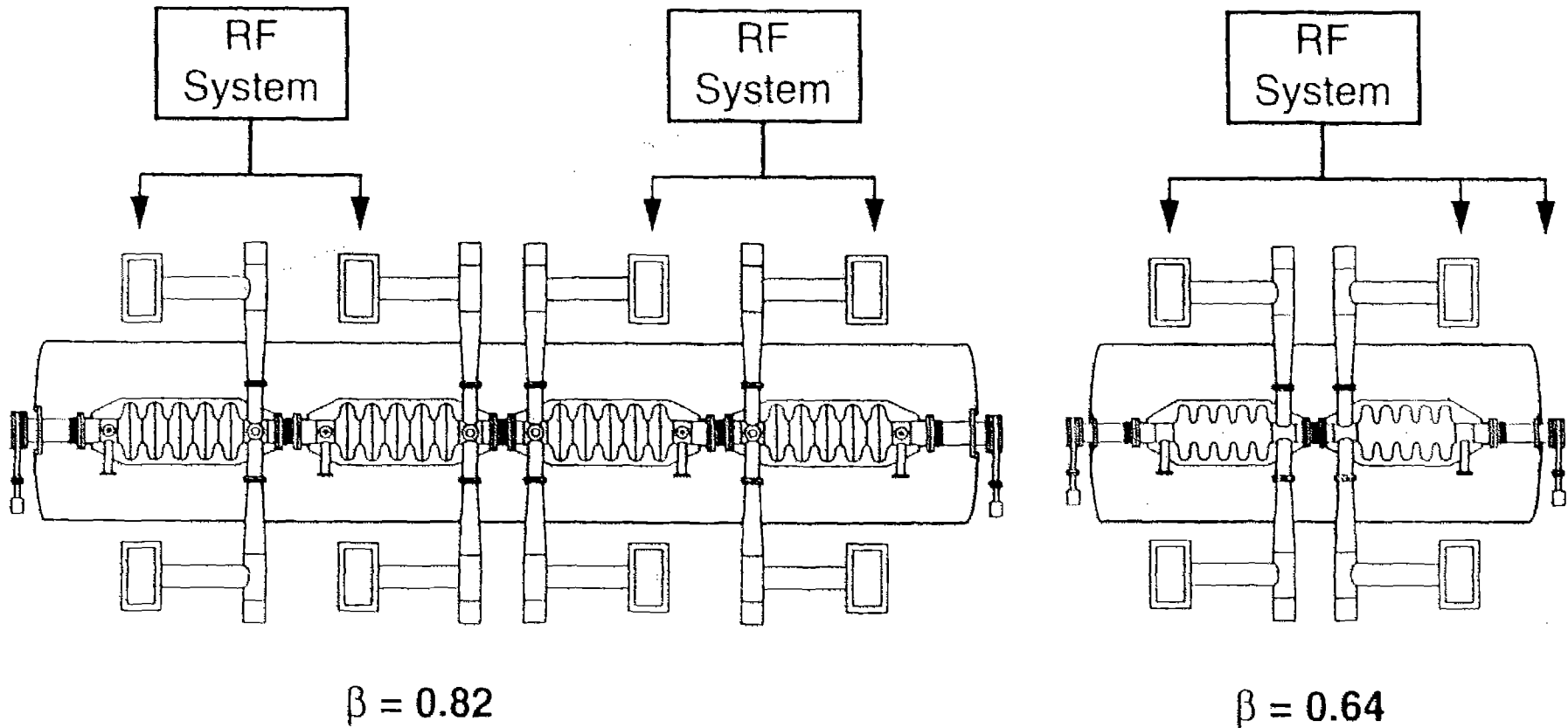

## **ATW Linac ED&D Program Will Focus on Accelerator Design and Performance Requirements that are Different from APT**

---

- **Development of high-gradient single-cell and multicell SC elliptical cavities for medium-beta ( $\beta = 0.48, 0.71$ ).**
- **Development of high-gradient single-cell and multicell SC spoke cavities for low-beta ( $\beta = 0.25, 0.35$ ) region.**
- **Development of short SC quadrupoles for SC linac cryomodules.**
- **Development of adjustable RF power couplers to provide efficient operation over full range of beam current.**
- **Prototyping of complete elliptical-cavity medium-beta cryomodules (including SC quadrupoles).**
- **Prototyping of complete spoke-cavity low-beta cryomodules (including SC quadrupoles).**

## Preliminary Cost Estimate for 1000 MeV 40 mA ATW Linac (12/97)

Component	Labor Hours					Thousand Dollars (1997)			
	Preliminary & Final Design (P&FD)		Component Procurement, Fabrication & Installation (PF&I)			Preliminary & Final Design (P&FD)	Component Procure, Fab., & Install (PF&I)	Purchased Material	Component Total
	Prof	Tech	Prof	Tech	Craft				
Injector	7,992	4,440	4,808	9,515	3,835	\$1,634	\$1,684	\$326	\$3,644
FFO	7,104	2,664	28,892	65,528	5,750	\$1,350	\$10,095	\$790	\$12,235
CCDTL	8,880	5,328	11,196	38,329	3,900	\$1,847	\$5,014	\$2,542	\$9,403
Spoke Resonator Cavities	21,312	28,416	14,208	35,520	8,880	\$5,683	\$5,479	\$21,000	\$32,153
Elliptical Cavities	31,968	53,280	15,431	41,873	10,327	\$9,377	\$6,232	\$44,252	\$59,861
RF Power	15,984	22,644	31,007	153,487	120,572	\$4,369	\$22,063	\$75,576	\$102,008
Cryoplant	17,760	35,520	7,000	10,000	0	\$5,683	\$1,920	\$37,000	\$44,603
Linac Controls	26,640	46,176	62,160	79,920	26,640	\$7,956	\$17,405	\$11,873	\$37,234

### Groundrules & Assumptions

- Hourly Labor Rates (\$/hr)
  - Professional \$160
  - Technician \$80
  - Craft \$40
- All estimates assume a functioning APT linac (in place talent pool)
- All linac (except Spoke Resonator) scaled from APT
- Spoke resonator estimates scaled from "grass roots" work done on IFMIF project
- Linac controls include all components from linac through cable runs and controlling computers
- Estimates above assume successful completion of a separate technology development program
  - cavity development: spoke resonator & elliptical
  - high SC fields
- 30% contingency scaled from APT/IFMIF values considering increased risk of the ATW technical requirements

*Linac System Subtotal (\$k) ==> \$301,141*

*30% Contingency ==> \$90,342*

<b>TOTAL LINAC SYSTEM COST ==&gt; \$391,483</b>
---

**\$391.5M**

**Note:** The Total ATW Linac System Cost Estimate of \$391M is highly preliminary.  
 The comparable Cost Estimate for the APT (3 kg) Linac is \$980M

# Summary

---

- **APT accelerator design and ED&D program is firmly established, has been intensively reviewed, and has high credibility. An integrated NC/SC linac is the Project baseline.**
- **ATW linac design rests on APT accelerator conceptual design, and ED&D program advances.**
- **ATW-specific linac design requirements emphasize higher electrical efficiency and shorter length compared with APT.**
- **ATW design solution pushes to higher accelerating gradients, and lower starting energy for SC linac.**
- **A modest extension of the APT program will have high payoff for support of an ATW-specific advanced linac design.**



Stages of development of  
Lead-Bismuth as a coolant for  
nuclear reactors in Russia

Prof. Yu. I. Orlov

State Scientific Center of Russian Federation  
Institute of Physics and Power Engineering  
249020 Obninsk, Russia

# Alexander Ilyich Leipunskii (1903-1972)

One of the founders of the IPPE. A member of Ukraine Academy of Sciences, he worked in the IPPE in 1949-1972, was a scientific supervisor of the institute and of all the trends of liquid metal reactor design.

In the early 1950s academician Leipunskii suggested using lead-bismuth eutectic as a coolant in nuclear reactors of transport systems.

Lead-Bismuth eutectic was chosen for its unique qualities.



### Pb - Bi phase diagram

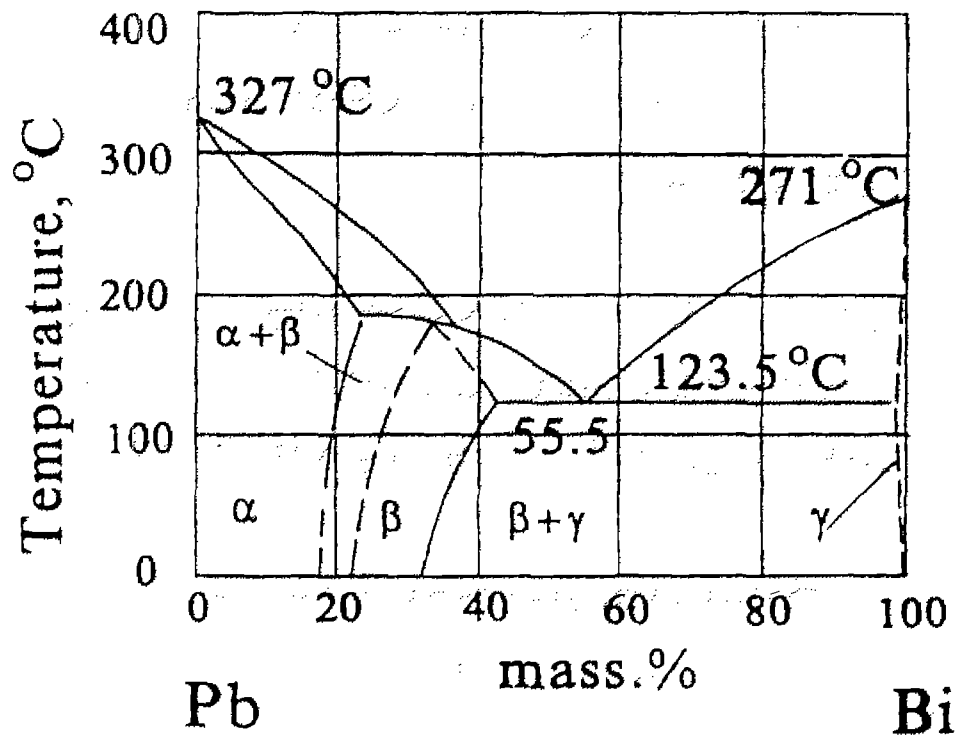



# The favorable properties of Pb-Bi eutectic

- The impossibility of explosion and fire at the alloy interaction with air, water and vapor because of **the low chemical lead and bismuth activity**
- The impossibility of the coolant boiling out with high energy deposition due to **the high boiling point** of Pb-Bi (1670° C).
- **The low working pressure** of the coolant in the circuit increases the facility safety, simplifies the equipment design and construction, makes significantly simpler working conditions for fuel elements

# Lead-Bismuth cooled reactors

- Since 1952 the IPPE has been engaged in designing nuclear power reactors cooled by the lead-bismuth alloy. Units like these are used in high speed, highly maneuverable, nuclear submarines.
- In the course of this work a team of specialists has been formed, an experimental basis has been created, and experience in investigation, design, construction and operation of this type of installation has been gained.
- Specific features of the reactors being developed required a complex of investigations to be done on reactor physics, heat transfer, hydrodynamics, coolant technology, material corrosion, safety, control and monitoring systems, development of fuel elements and equipment capable to function in the lead-bismuth alloy medium.
- According to some publications intensive research on lead-bismuth was conducted at the same time in United States and Canada.

# Lead-Bismuth cooled reactors

- In early 1960s the first nuclear submarine, in which lead-bismuth alloy was used as a coolant, was commissioned.
- However, in the second half of 1968 there was an accident with a nuclear reactor.
- The analysis that followed showed that the cause of the accident was lack of full knowledge about the coolant.

# Pb-Bi alloy properties that can negatively affect reactor performance .

- The Pb-Bi coolant is **comparatively corrosive** to the construction materials.
- Pb-Bi coolant can be **contaminated by solid admixtures** during operation due to interaction with construction materials and oxygen.
- At the first stage of work with Pb-Bi coolant these factors caused the following
  - closing of Pb-Bi programs in USA
  - decrease of operating life of the first Nuclear Power Plant.

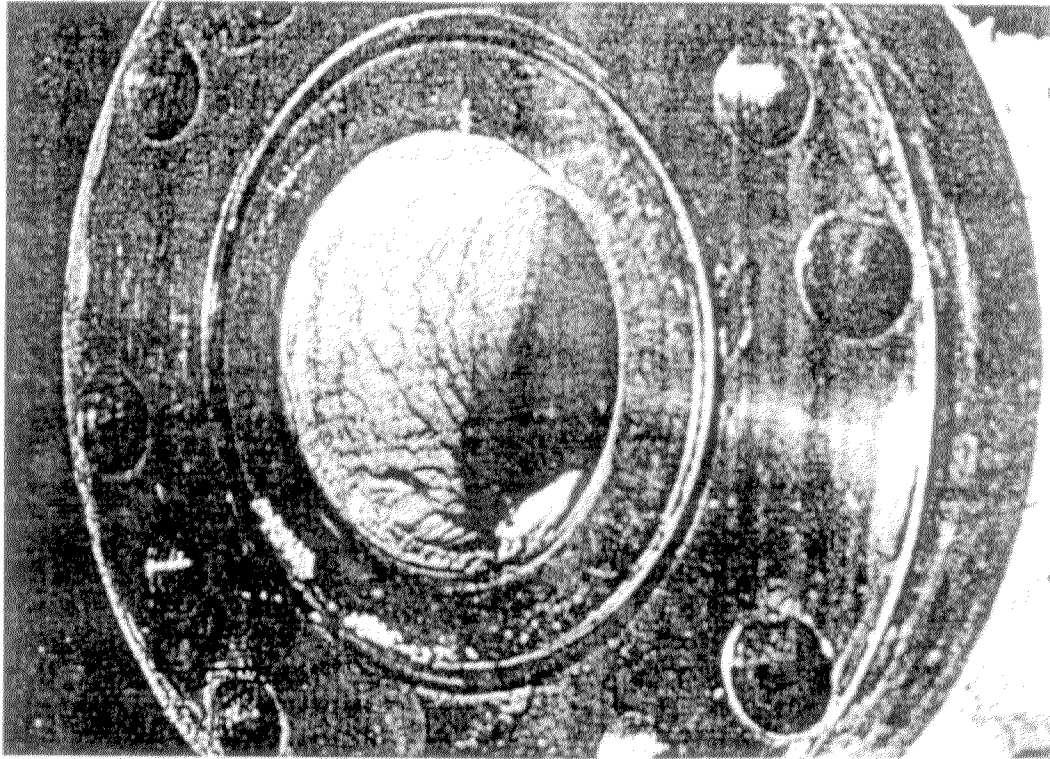

Pipe condition before lead-bismuth technology improvement program

# Principle tasks of Pb-Bi coolant technology

- For the long and safe operation of Pb-Bi coolant facilities it was necessary to do the following.
  - **Ensure the corrosion-erosion resistance of the construction materials used.**
  - **Ensure the cleanliness of coolant and inside surface of the equipment where the coolant circulated.**
- In order to perform these tasks an extensive program of research was carried out.
  - Pb-Bi alloy properties, physical and chemical processes that take place in anisothermal circuits, corrosion resistance of construction materials, admixture sources and influence of all these factors on efficiency of the facility were studied.
  - Large experimental base, including dozens of circulation facilities, was created in Russia and is still operating.
  - Hundreds of experts were involved in solving these problems.

# Corrosion Resistance of Materials

- Corrosion resistance of materials can be improved by
  - **selecting suitable steel or creating a special one**
  - **creating protective film on the steel**
  - **correcting the coolant quality (O<sub>2</sub>, particulates)**
- Equipment in Pb-Bi facilities, that has to work at temperatures up to 450C, requires ordinary stainless steel of kinds ЭЯ-1Т (1X18H10T), ЭП-302 (1X15H9C3Б1) of the austenite class.
- Equipment that has to work at temperatures above 450C is produced from the special steel of ferritic-martensitic class.
- The protective film consists of oxide compounds of steel components. The basis of the film is Fe<sub>3</sub>O<sub>4</sub>.

Reaction of formation and dissociation of oxide Fe<sub>3</sub>O<sub>4</sub> is described by the following formula.

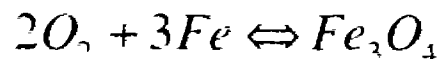

with equilibrium constant

$$K = \frac{a_{[Fe_3O_4]}}{a_{[O_2]}^2 a_{[Fe]}^3}$$

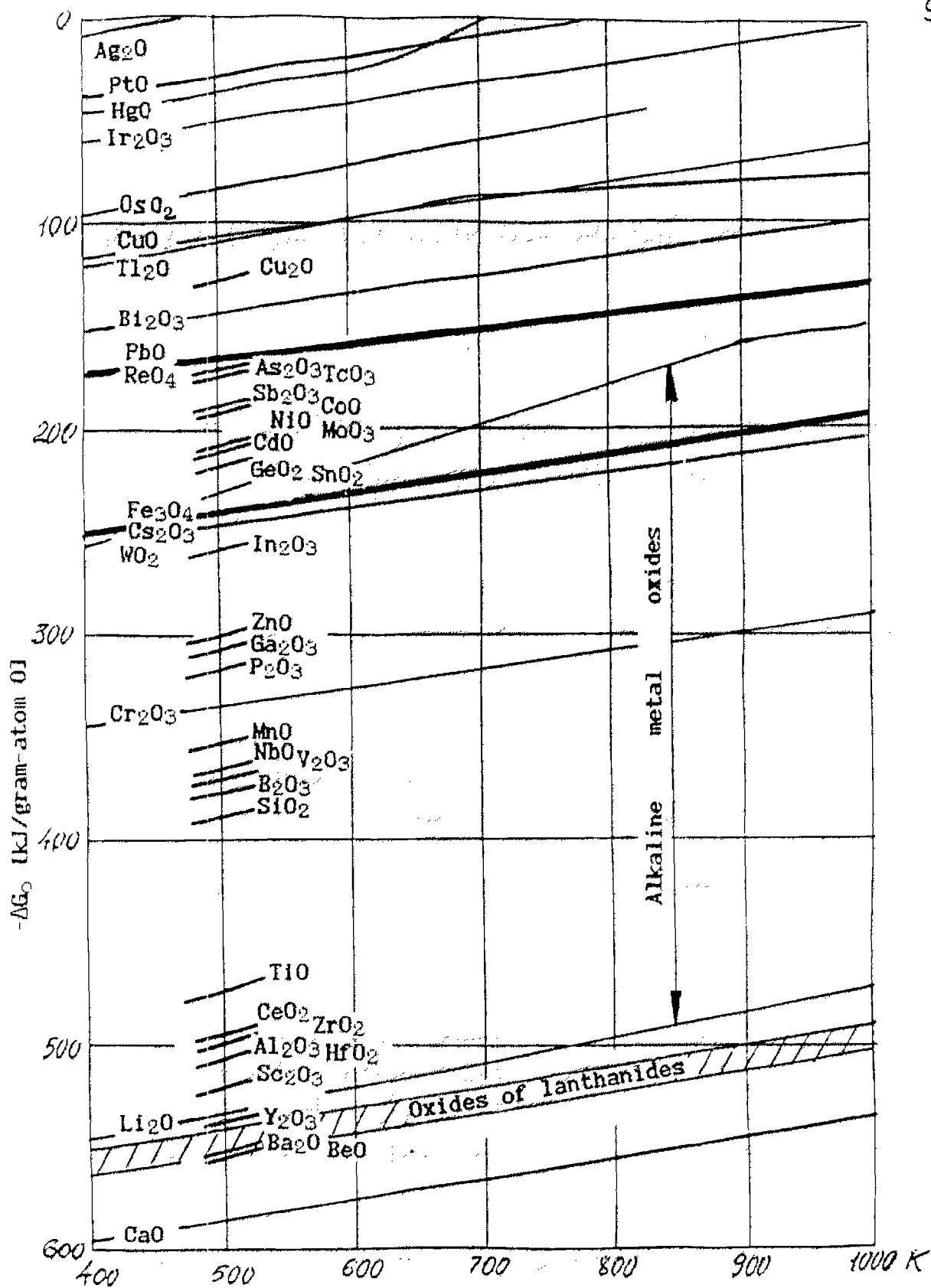

Fig. Standard free energy change for the oxide formation reactions.



# Corrosion Resistance of Materials

- If there are conditions for existence of phase  $Fe_3O_4$ , then  $a_{[Fe_3O_4]} = 1$ , and connection between  $a_{[Fe]}$  and  $a_{[O]}$  has fixed properties.
- Decrease in concentration of oxygen dissolved in alloy is possible up to the values that are equal or less than equilibrium with  $Fe_3O_4$ .
- On the other hand, existence of a considerable amount of oxygen in a circuit is undesirable as this can cause accumulation excess amount of oxide admixtures, primarily, coolant oxide.
- **It is necessary to maintain amount dissolved oxygen at a fixed level.**
- \* Testing for dissolved oxygen concentration in alloy was done by a controller of oxygen thermodynamic activity. Controller, designed and made in IPPE, uses principle of galvanic concentration register with solid electrolyte. Methods and equipment for oxygen activity correction were developed also.
- \* These device and procedures provided corrosion resistance for structural materials at all stages of Pb-Bi facility operation.

# Temperature dependence of thermodynamic oxygen activity and concentration of oxygen and iron for lead-bismuth

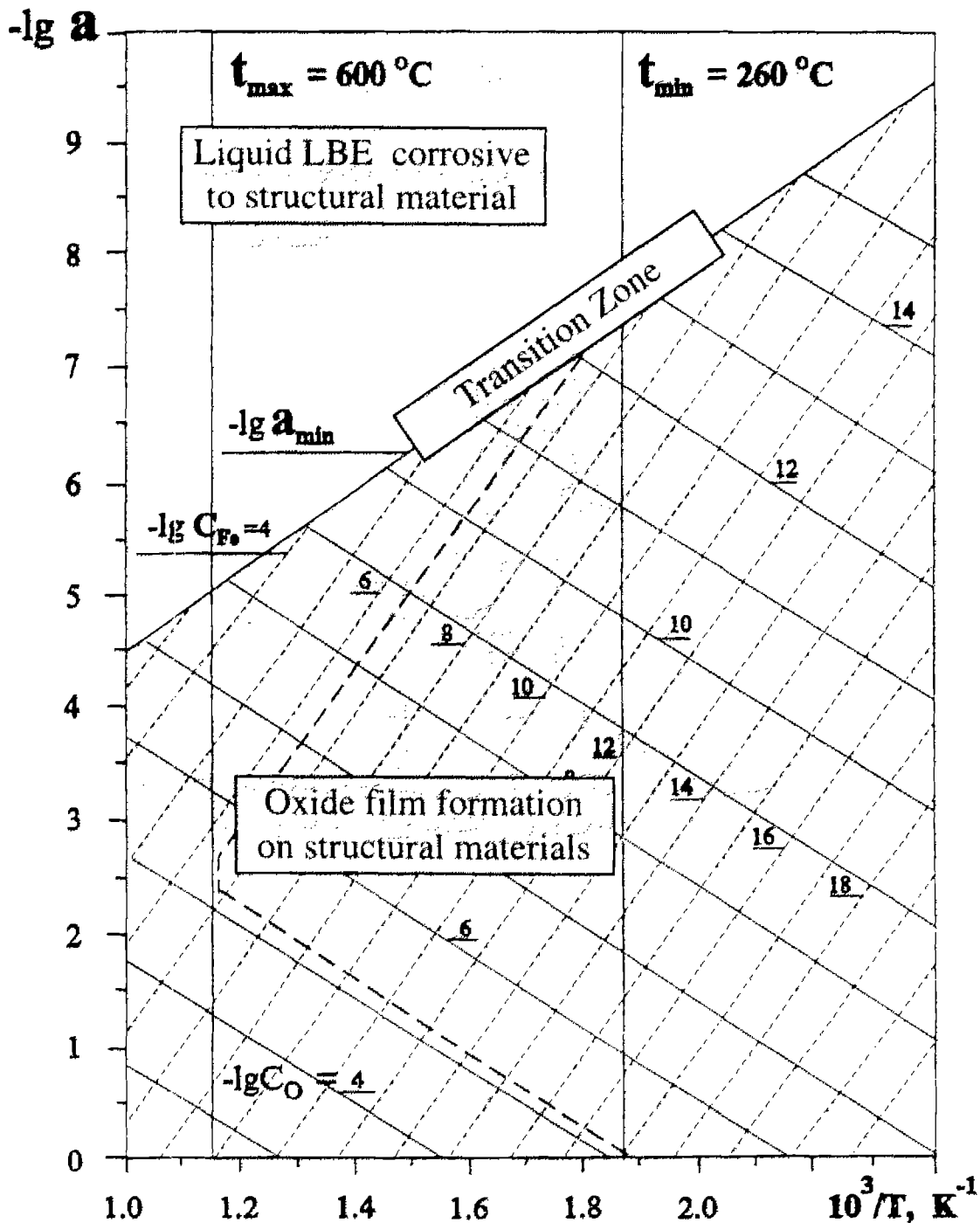

# Measuring of thermodynamic activity of oxygen.

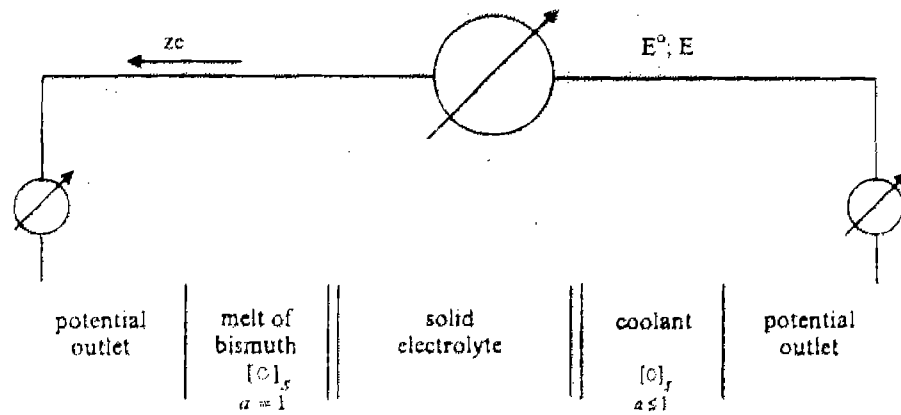

Measuring scheme of galvanic concentration cell.

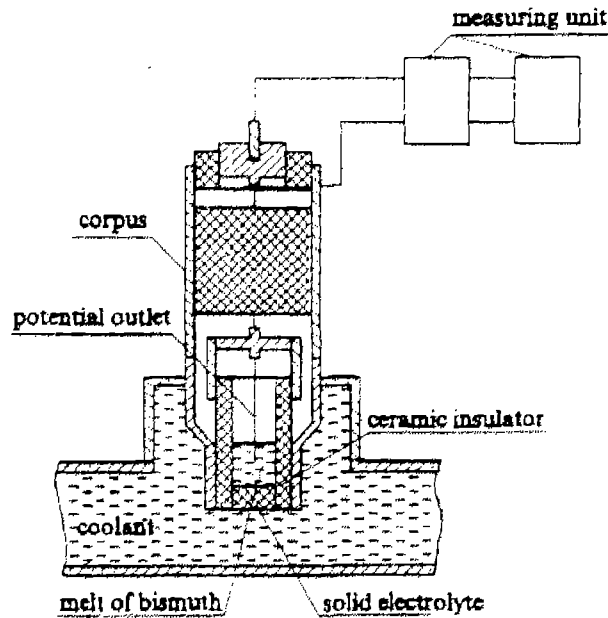

Principle scheme of device for measuring of thermodynamic activity of oxygen.

$$E^0 = \frac{\Delta G^0_{Bi_2O_3} - \Delta G^0_{PbO} - RT \ln a}{2F}$$

$$\lg a = -\frac{10094}{T} (E^0 - 0.088) - 0.18$$

$$t = \frac{E_M}{E^0_{Max}}$$

# Cross sections of steels exposed in forced-circulation lead loop for 3000 h at 550 °C

## Austenitic stainless steels

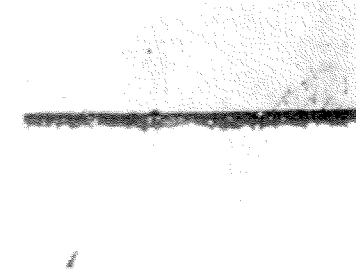
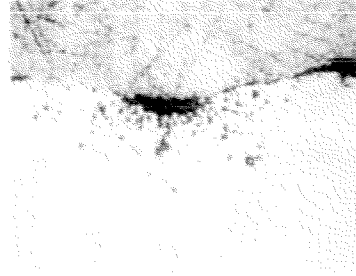
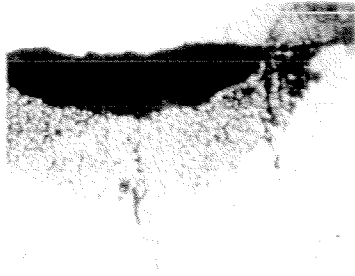

## Low alloy steels

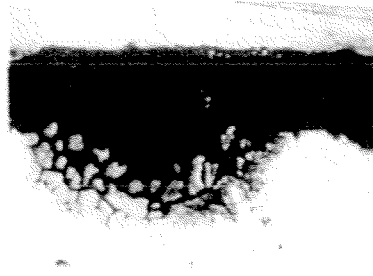

Corrosion in structural materials

Tranzition zone

Oxide film on structural materials

**CRISM** "Prometey"

# Ensuring of cleanliness of circulation circuit and coolant

- During the long facility operation **accumulation of coolant admixtures**, which can cause some negative effects, inevitably takes place. The composition of depositions formed in the circuit depend on the construction materials, regime of operation and can vary greatly.
- The methods and devices for removal of lead oxide (the basic admixture) by reducing it to lead directly in the circuit were developed in the IPPE.  
**Chemical reaction of oxides with hydrogen was applied**  
$$PbO + H_2 = Pb + H_2O$$
- The chosen conditions for this reaction do not allow reduction of the oxides that constitute the base of the protective films on the construction materials.
- For the removal of admixtures that cannot be reduced chemically **special filters** were created.



Before cleaning



After cleaning

# Conclusion

As a result of the work done on lead-bismuth cooled reactors the following problems were solved

- 1 Scientific base for Pb-Bi coolant treatment technology was determined.
- 2 New construction materials for use in contact with Pb-Bi alloy at temperatures up to 600C were chosen or created
- 3 Methods and devices for control of Pb-Bi alloy quality were created.
- 4 Methods and devices to maintain Pb-Bi alloy quality were determined.
- 5 Methods and devices for removal of admixtures from the coolant and circuit surfaces were created.



- Complex of methods and means, which are named “Heavy Coolant Technology” (HCT) was carefully tested at many experimental facilities, at a prototype of a nuclear power plant and was applied to industrial facilities.
- There were no facilities’ breakdowns caused by the coolant during operations due to use of this technology.
- At present IPPE is the world leader in lead-bismuth coolant technology.

# Influence of Spallation Products on Mass Transfer Process

- New elements generated by proton beam in spallation reactions can take part in different chemical reactions disturbing chemical equilibrium in the circuit. The most important among these reactions are oxidizing reactions with formation of nonsoluble oxides. Reactions with reduction (i.e. with taking oxygen from oxide) are especially important since they destroy protecting films on structural materials.
- New elements formed in spallation reactions may be divided into three groups
  1. elements with oxygen affinity less than lead will be dissolved in lead-bismuth without oxide formation (Au, Ag, Pt, Hg, Os, Cu, Tl, Pb, Bi)  
$$\Delta G \geq -160 \text{ kJ / g - atom at } 300^\circ \text{ C}$$
  2. elements with oxygen affinity between the values for lead and iron will be dissolved or oxidized depending on thermodynamic activity of oxygen.  
(Re, As, Te, Sb, Co, Ni, Mo, Sn, Fe)  
$$-160 \text{ kJ / g - atom} > \Delta G > -230 \text{ kJ / g - atom}$$
  
at  $300^\circ \text{ C}$
  3. elements with oxygen affinity higher than iron will be able to cause reduction in  $\text{Fe}_3\text{O}_4$  and destroy protective film in some conditions (lantanides, halogens, alkaline elements, Be, Y, Sc, Al, Ge, Ti, Hf)  
$$\Delta G < -230 \text{ kJ / g - atom at } 300^\circ \text{ C}$$
- In the whole, analysis demonstrated that for 10-20 MW circuits influence of admixtures generated by proton beam on mass transfer process can be noticeable and requires special attention

# Pb-Bi and Pb coolant Experimental Base in Russia

	Facilities	Investigation's field	Coolant	Temperature $^{\circ}C$	Coolant flow rate $m^3 / hr$	Coolant Volume $m^3$
1	CBT-3M	Thermohydraulics Technology	Pb-Bi	160-450	20	0.1
2	ИСР	Technology Corrosion	Pb, Pb-Bi	160-650	6	0.1
3	ТТ-1М	Technology Corrosion	Pb-Bi	240-600	6.5	0.18
4	ТТ-2М	Technology Mass transfer	Pb-Bi	250-550	5	0.2
5	СМ-1	Corrosion Mass transfer	Pb-Bi	270-650	5	0.1
6	СМ-2	Corrosion Mass transfer	Pb	350-650	2.5	0.07
7	ИУ-1	Corrosion Mass transfer	Pb	350-620	5	0.1
8	ИУ-2М	Corrosion Mass transfer	Pb-Bi	270-650	2	0.1

# Pb-Bi and Pb coolant Experimental Base in Russia

	Facilities	Investigation's field	Coolant	Temperature $^{\circ}C$	Coolant flow rate $m^3 / hr$	Coolant volume $m^3$
9	СПРУТ	Thermohydraulics Technology	Pb-Bi	150-500	5.0	0.12
10	H-8000	Investigation of large scale equipment performance	Pb-Bi	150-520	120.0	1.2
11	ИГ	Investigation of small and medium scale equipment performance	Pb-Bi	150-520	2.0	0.4
12	БТР	Investigation of small and medium scale equipment performance	Pb-Bi	150-520	5.0	0.08
13	"Поток -1"	Corrosion	Pb-Bi	150-650	5.0	0.1
14	"Поток -2"	Corrosion	Pb	340-650	5.0	0.1
15	ФХТ	Thermohydraulics Technology	Pb-Bi	150-520	12.0	0.5

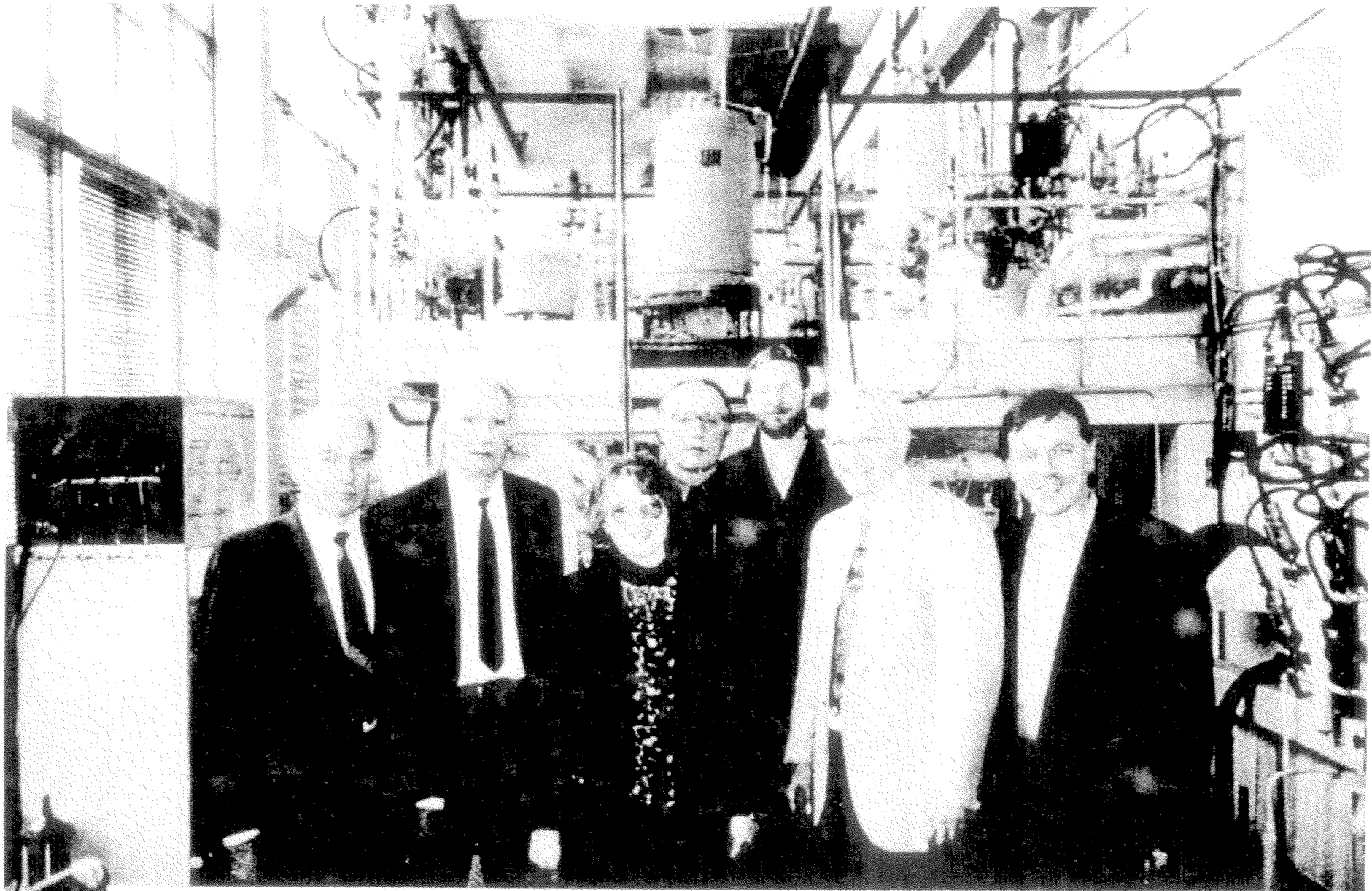

**Los Alamos ATW Project Members at the IPPE LBE Test Facility**

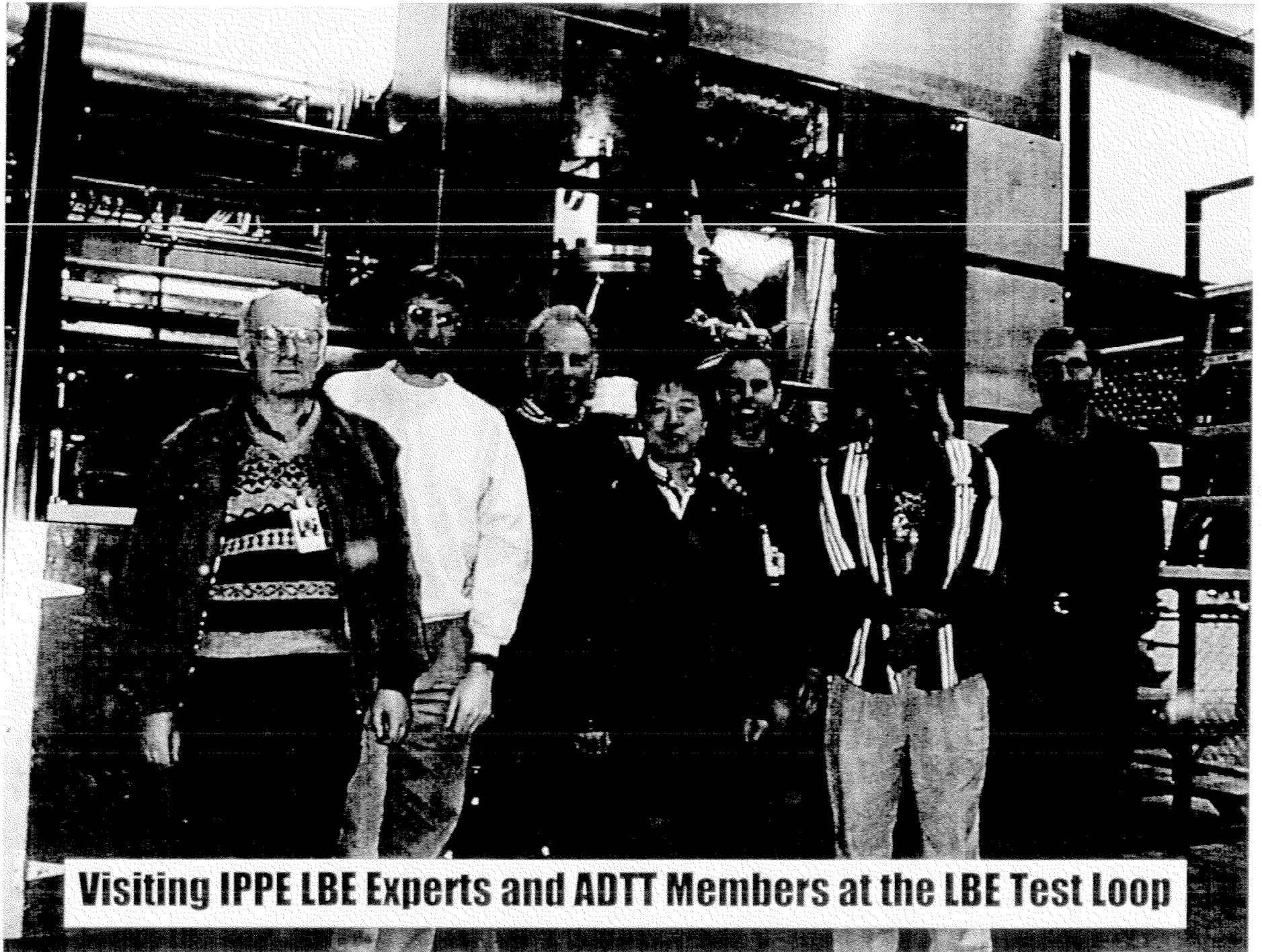

**Visiting IPPE LBE Experts and ADTT Members at the LBE Test Loop**

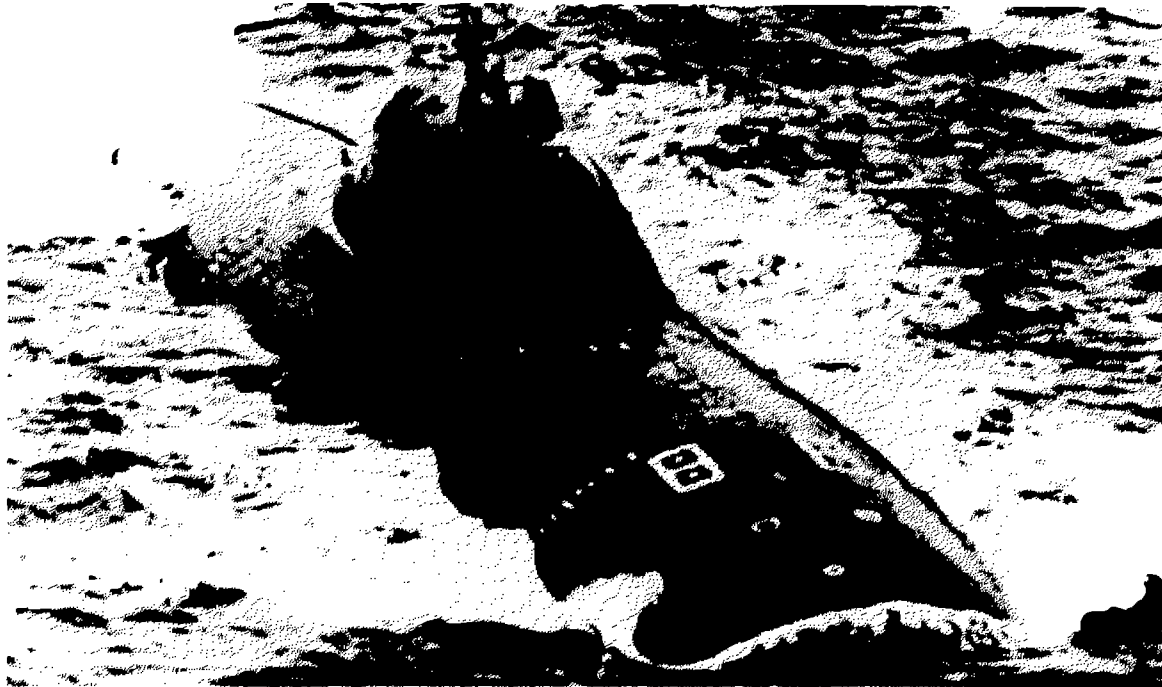

## **EXPERIENCE OF THE LEAD-BISMUTH COOLANT USE.**

A.Dedoul, IPPE, Obninsk, Russia

V.Kutanov, EDO "Gidropress", Podolsk, Russia

## **☑ Lead-bismuth coolant use issues:**

- **Lead-bismuth coolant technology and quality control.**
- **Corrosion, erosion and mass transfer.**
- **Radioactive safety problem including Po.**
- **Freezing/defreezing problem.**
- **Thermohydrodynamic problems.**



**☑ Issues resolved by experience of lead-bismuth coolant use in Nuclear facilities development, construction and operation:**

- **Two ground reactor facilities.**
- **Submarines with lead-bismuth cooled reactors.**
- **Industrial applications.**
- **Two test rigs for fuel rod reliability testing at reactors MIR and MR.**

Nuclear steam supply system module

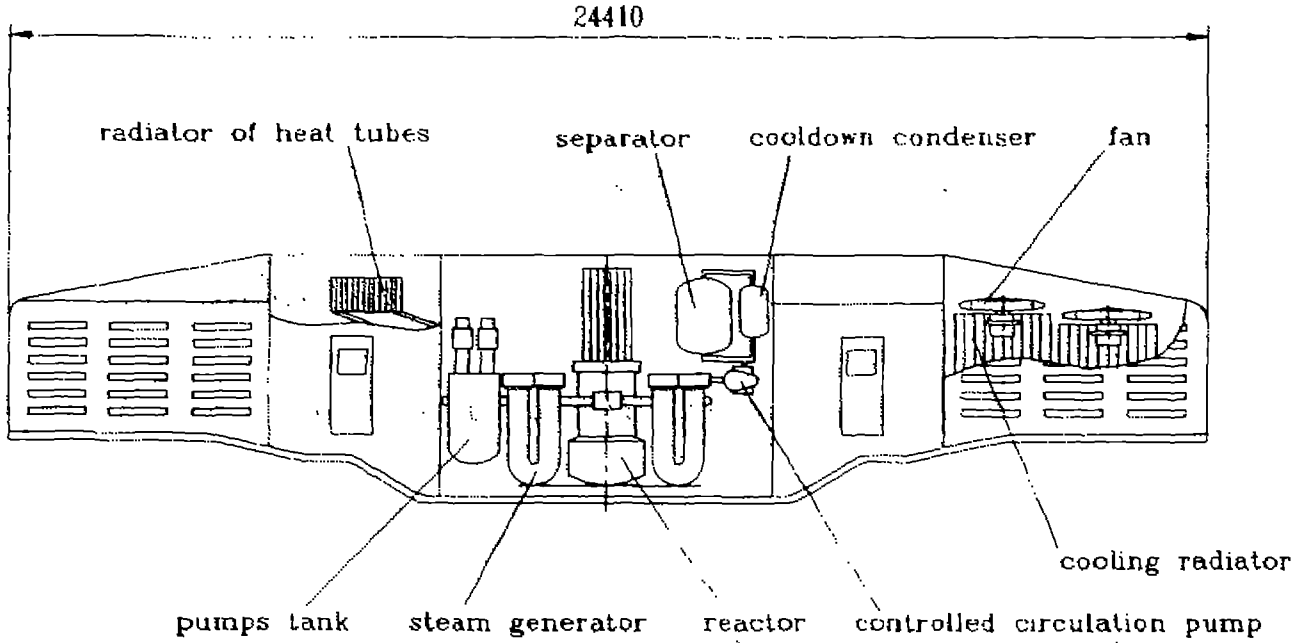

**1-st generation design**

# 2-nd generation design

BRUS-150  
Reactor plant of enhanced safety  
with liquid-metal coolant

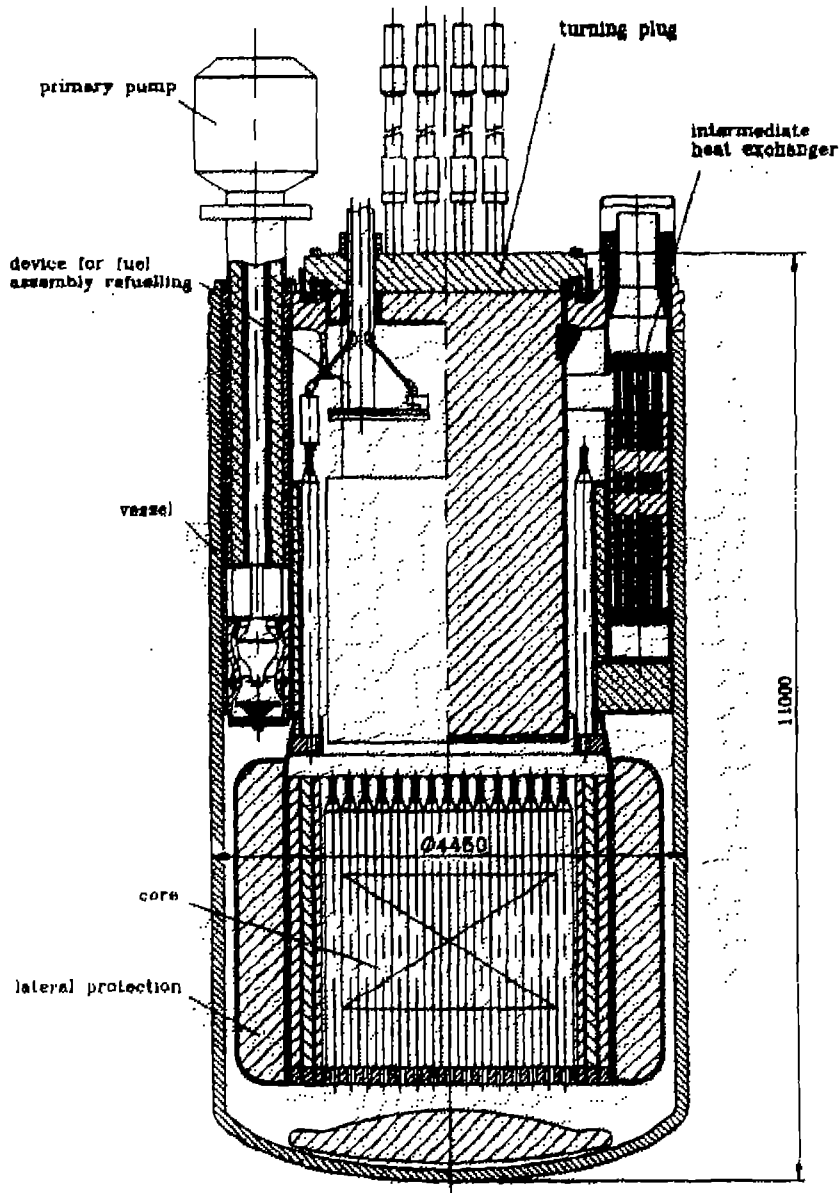

# Improved generation design

SVBR-75  
Reactor plant of enhanced safety  
with liquid-metal coolant

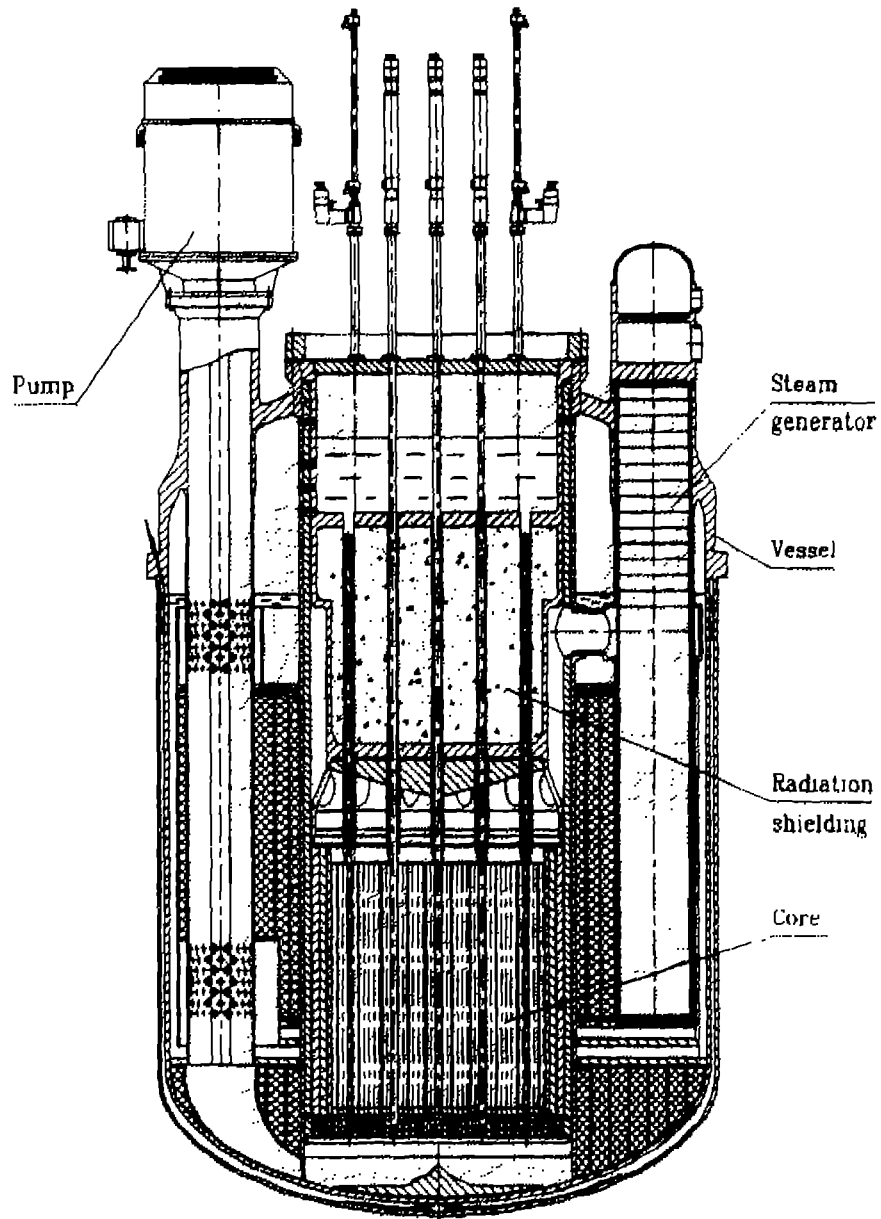

# LANL/IPPE/Gidropress spallation target

The target system with horizontal injection beam for LANL

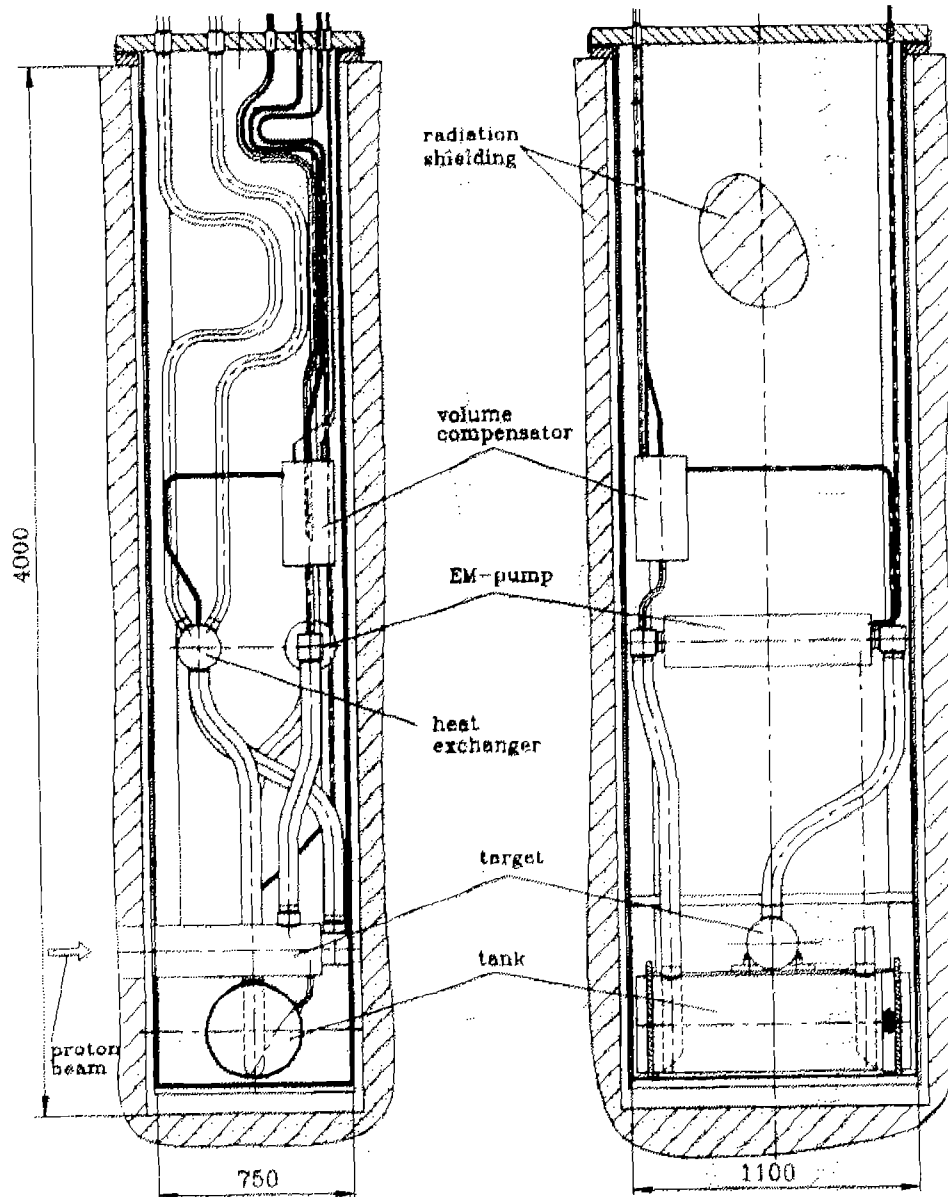

## **✓ Applicability of available experience to ATW**

### **development:**

- Available experience is fully applicable.**
- The volume of theoretical, experimental and design knowledge is enough for preliminary evaluation of ATW designs.**

# Engineering, technological and safety problems of ATW facility design.

Engineering problem	Variants	
Coolant type	Pb-Bi	Pb
Target design	Windowed	Windowless
Target cooling system	Separate circuit	Joint with blanket cooling system
Number of circuits	2	3
Coolant circulation	Forced circulation	Natural convection
Fuel type	Depends of fuel cycle and goals of ADS introduction into nuclear industry	
Fuel rod type & fuel assembly design	Spacing the fuel elements by the rib faces	Spacer grid use



Complex coolant technology issues			Safety issues		
Freezing - defreezing	Coolant technology	Po problem	Loss of heat sink accident	Steam generator tube rupture	Other safety assurance problems

***LANL/IPPE/EDO-GP COLLABORATION  
PROGRAMS ON  
LIQUID LEAD-BISMUTH TECHNOLOGY***

**Los Alamos National Laboratory  
- ATW Project -**

**Presented by: Ning Li**

***Contributions from: Y. Orlov, E. Yefimov, IPPE; EDO/GP  
J. Stubbins, Univ. of Illinois  
M. Bjornberg, X. He, W. Gregory, LANL***



# ***Outline***

## **Part I. LANL/IPPE/EDO-GP 1-MW LBE test target**

**IPPE: Institute of Physics and Power Engineering, Obninsk**

**EDO-GP: Experimental Design Organization-Gidropress, Podolsk**

## **Part II. LANL/IPPE polonium removal technology**

## ***Part I.***

# ***LANL/IPPE /EDO-GP 1-MW LBE Test Target***

**ISTC #559: Funding for IPPE/EDO-GP to design and fabricate a 1-MW liquid LBE spallation neutron target to be tested at Los Alamos by 2000**

**Objective: Perform thermal hydraulic and in-beam radiation testing**

### **Task Plan(5-year):**

- LANL assists IPPE in design and verification: target specifications, neutronic, thermal hydraulic simulations (97-98)
- IPPE/EDO-GP will fabricate the target hardware (98-99)
- LANL will prepare the testing facility and support systems (98-00)
- LANL/IPPE/EDO-GP will operate and test the target (2000-2001)
- Post-test examination and component performance assessment

## ***ADTT Simulation Work for Target Design***

- **Neutronic calculation to find neutron production and heat deposition**
- **Thermal hydraulic simulations to ensure operation within material limits**

# *Test Target Configuration (Sideview)*

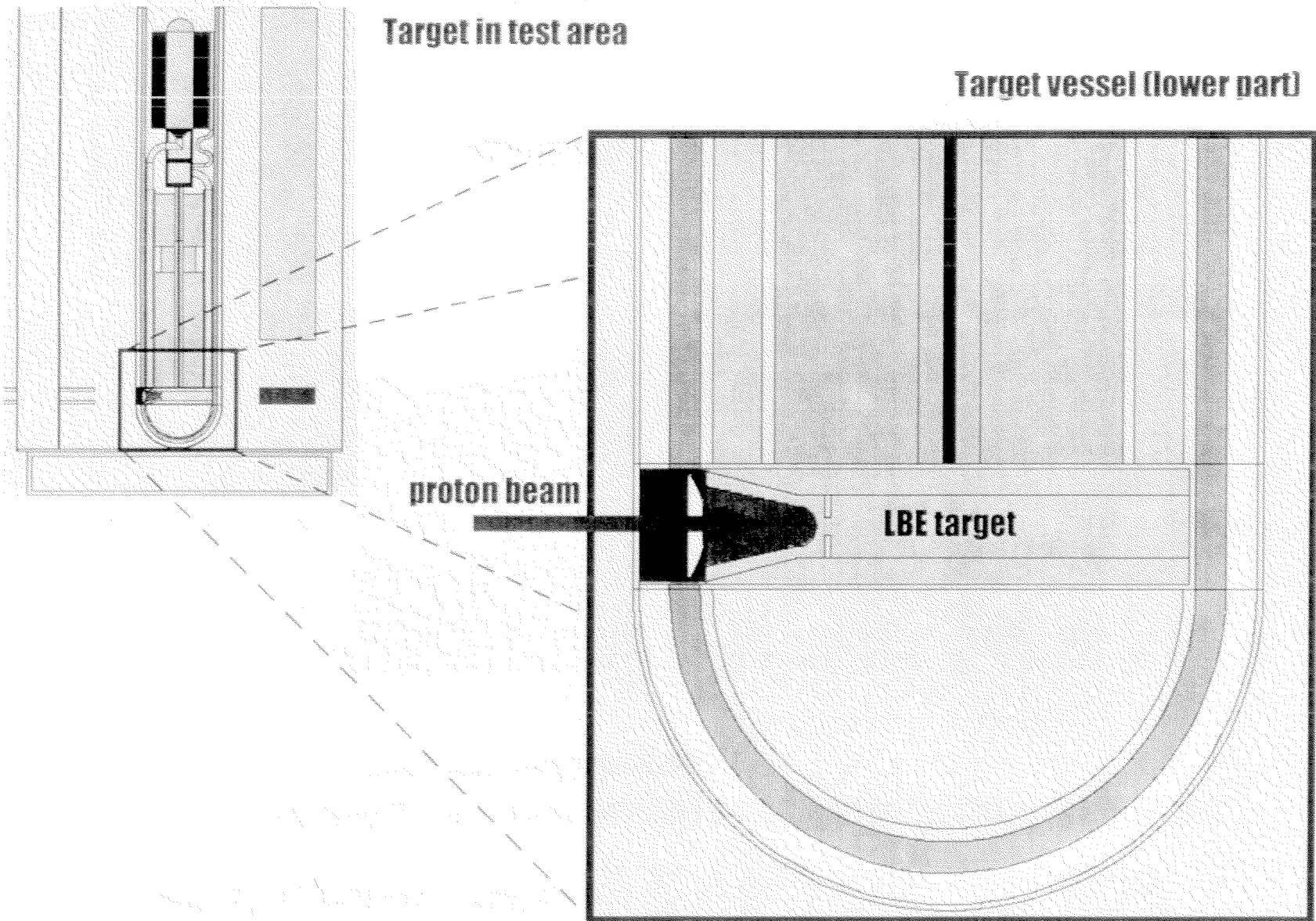

# Heat Deposition in Target and Window

The 1.25 mA, 800 MeV proton beam hits the lead-bismuth target after passing through two 1.5 mm thick Inconel windows.

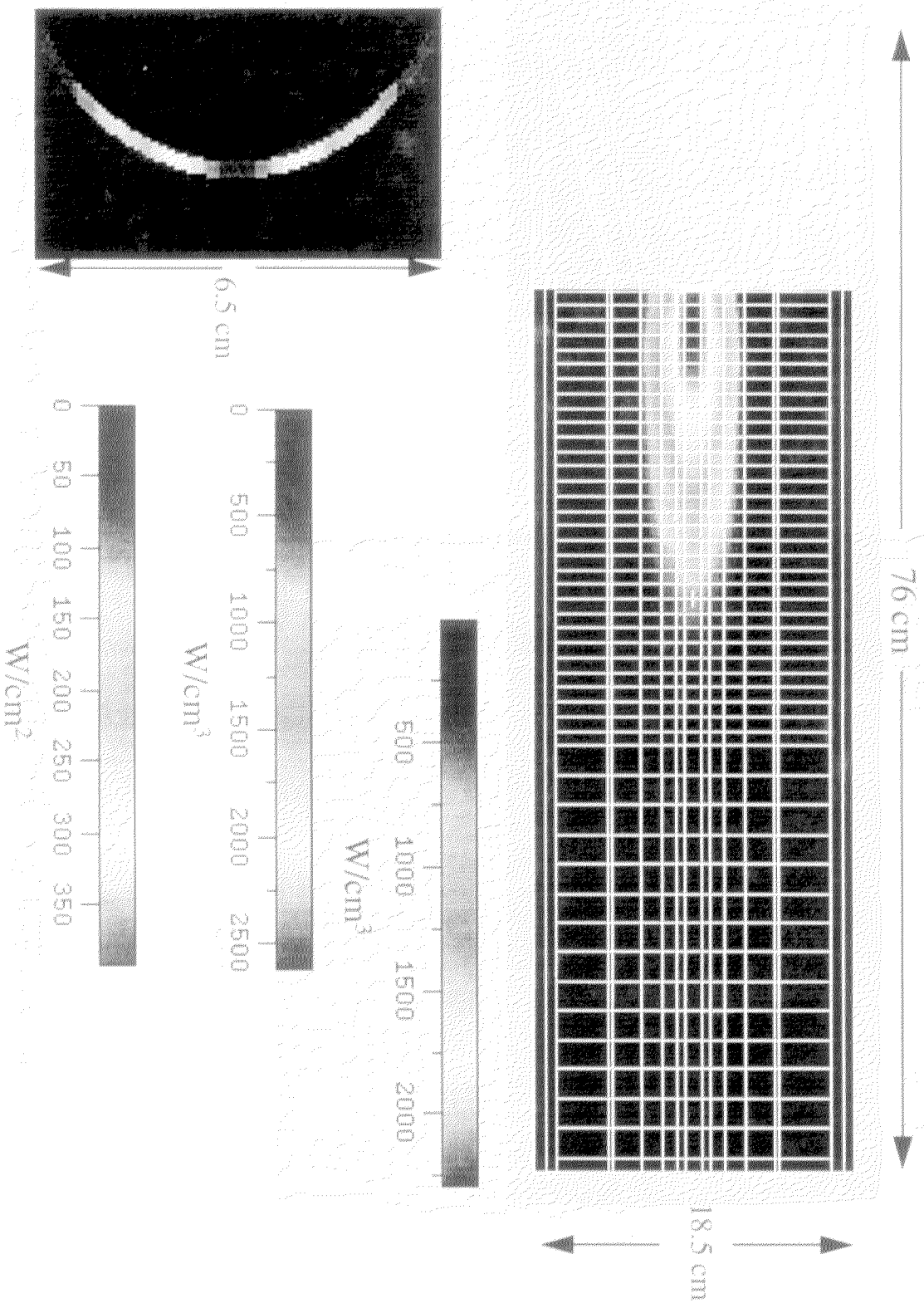

# Neutron Flux around Target (Top View)

Peak flux =  $3.85E+13$  n/cm<sup>2</sup>/s

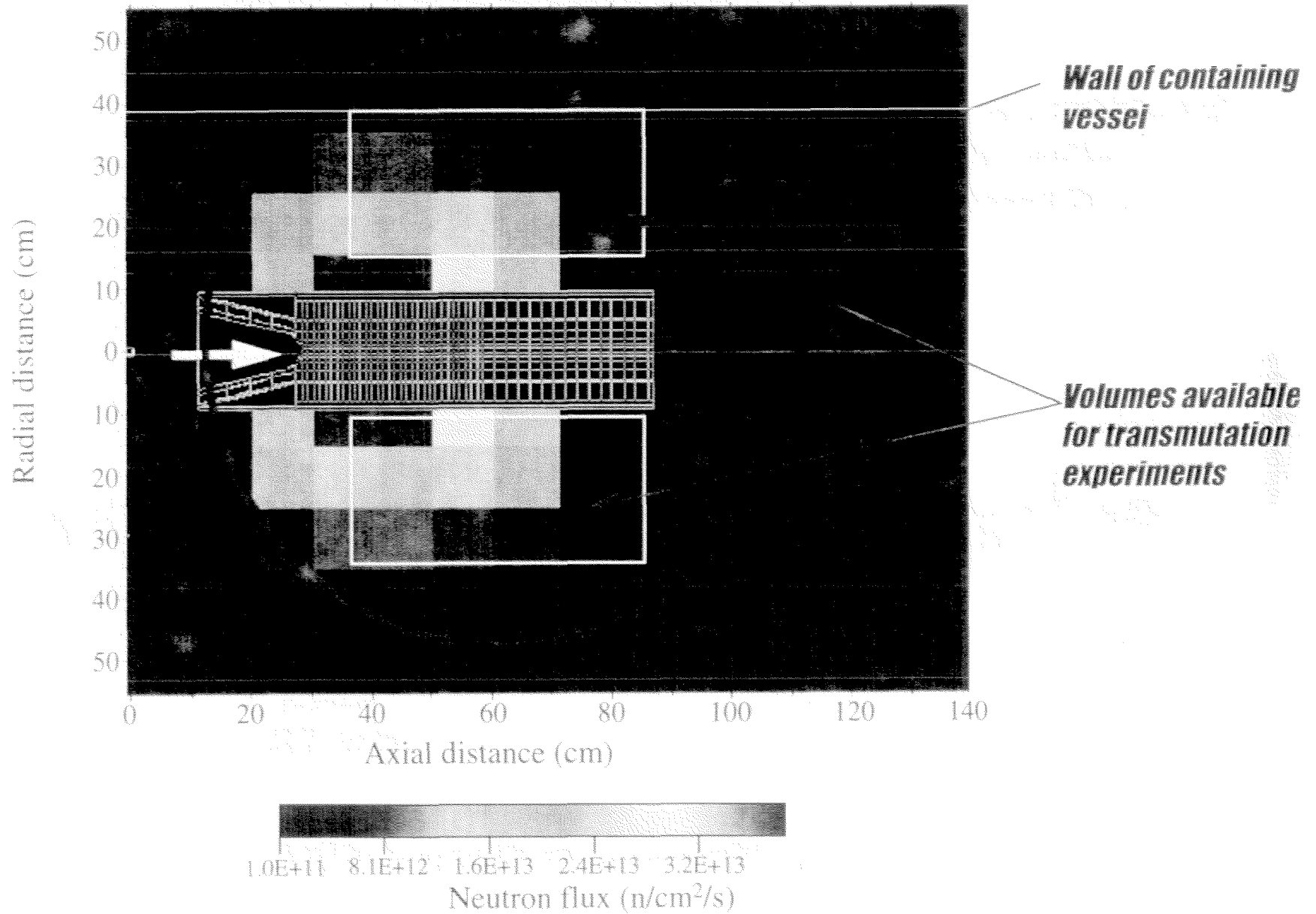

# Flow Path in Target Design

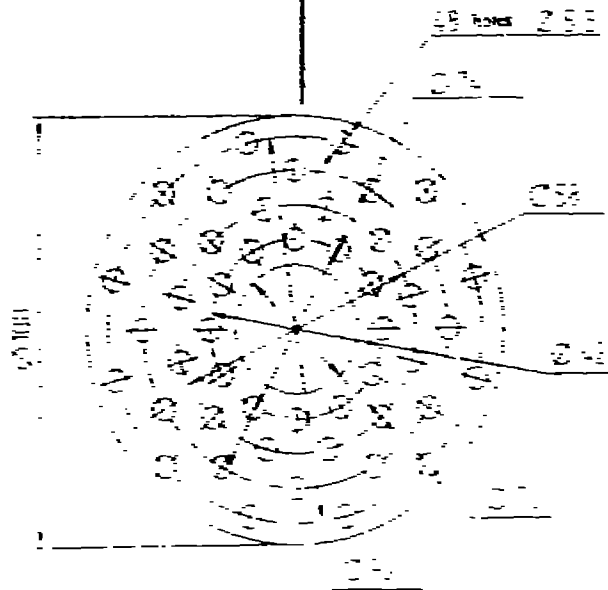
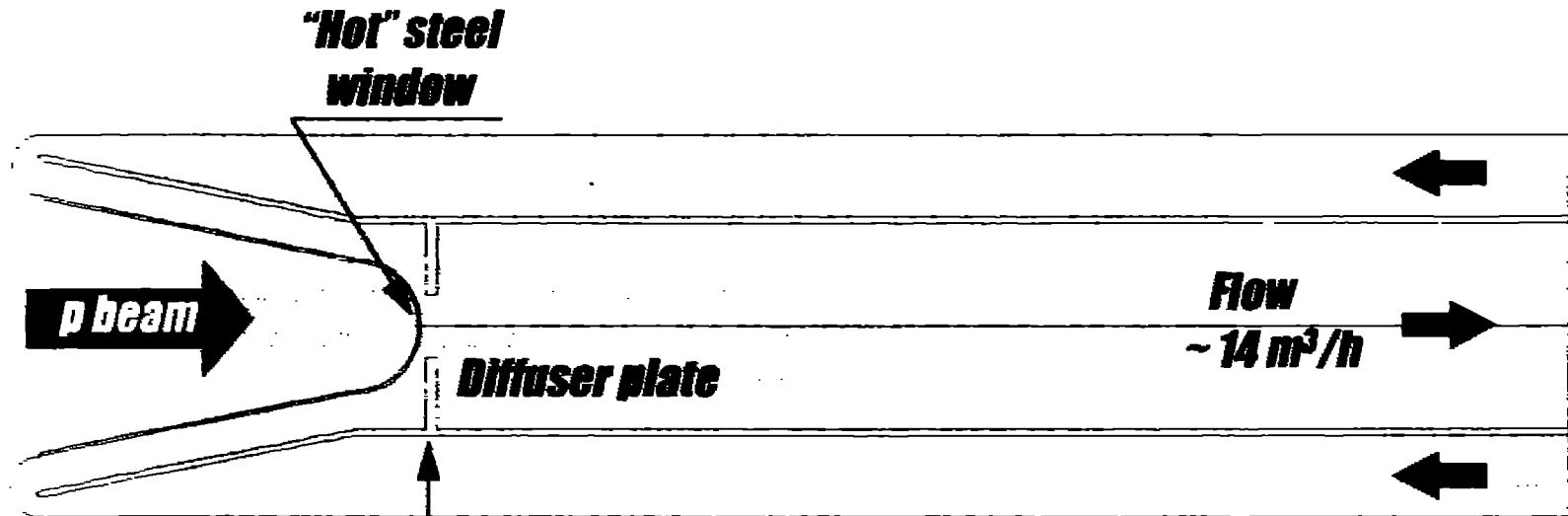

**Diffuser plate: directs more coolant flow to the center of the window; holes represented by effective porosity  $\epsilon$  for 2D simulations**

# *Simulations Show Window Cooling is Sufficient*

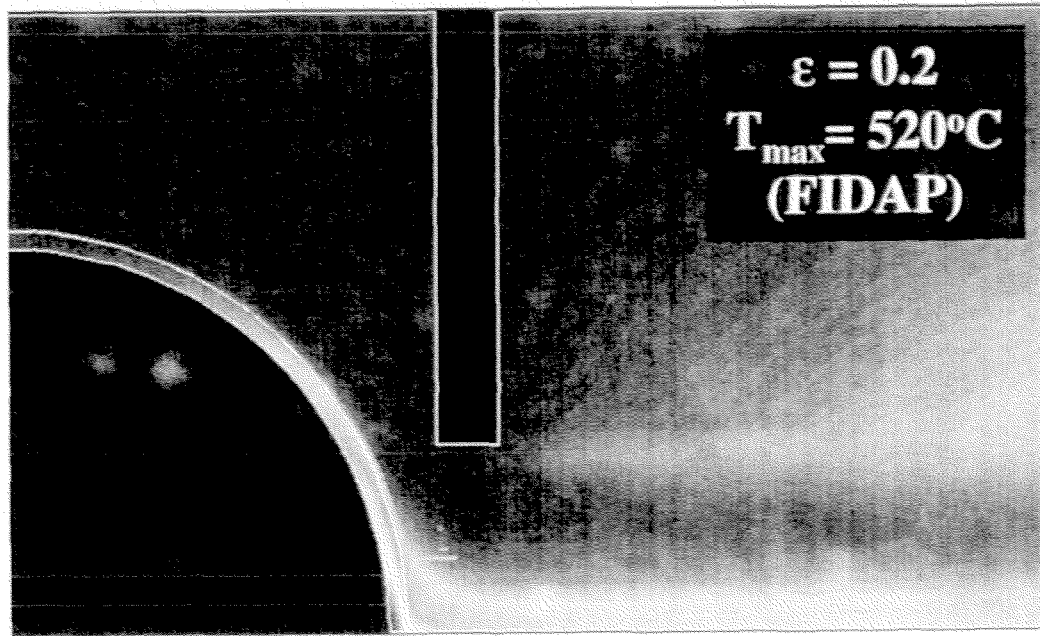
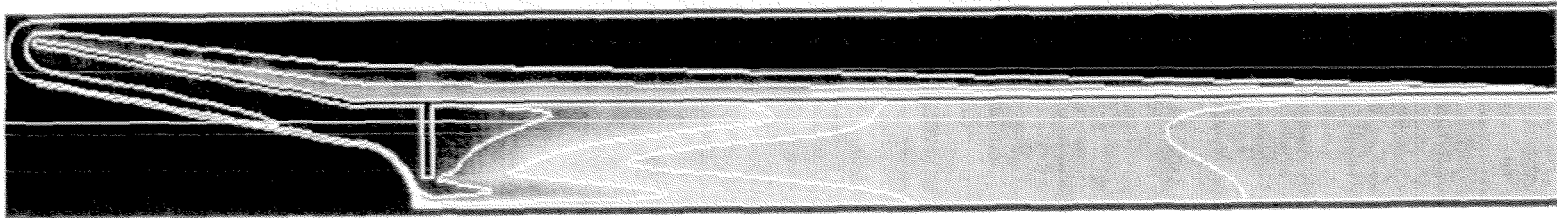

220°C

520°C



# ***Acceptable Temperature Limit (600°C) Can be Maintained in Target Design***

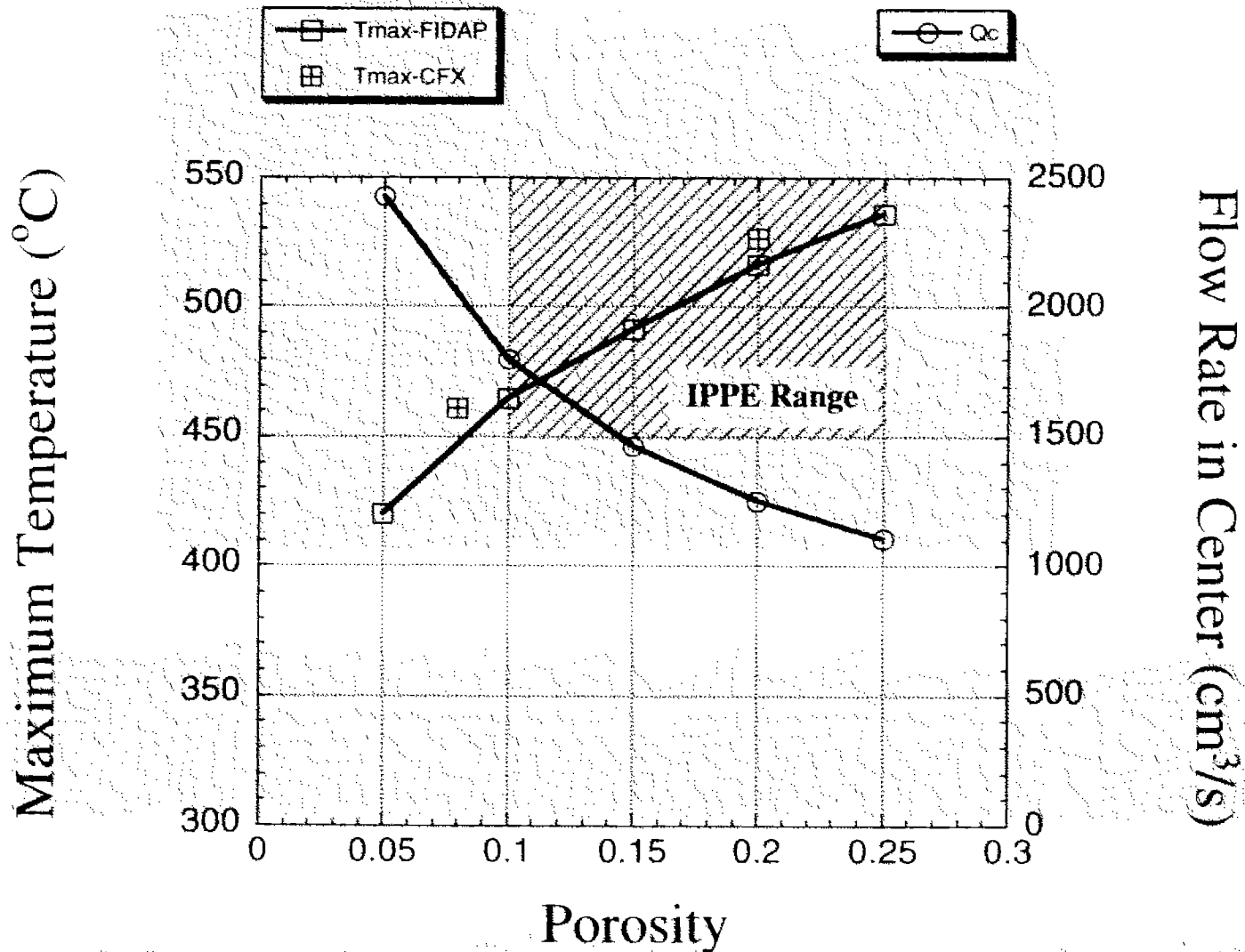

# Maintain Proper Oxygen Level for "Self-healing" Protective Film

Free Energy of Oxide Formation

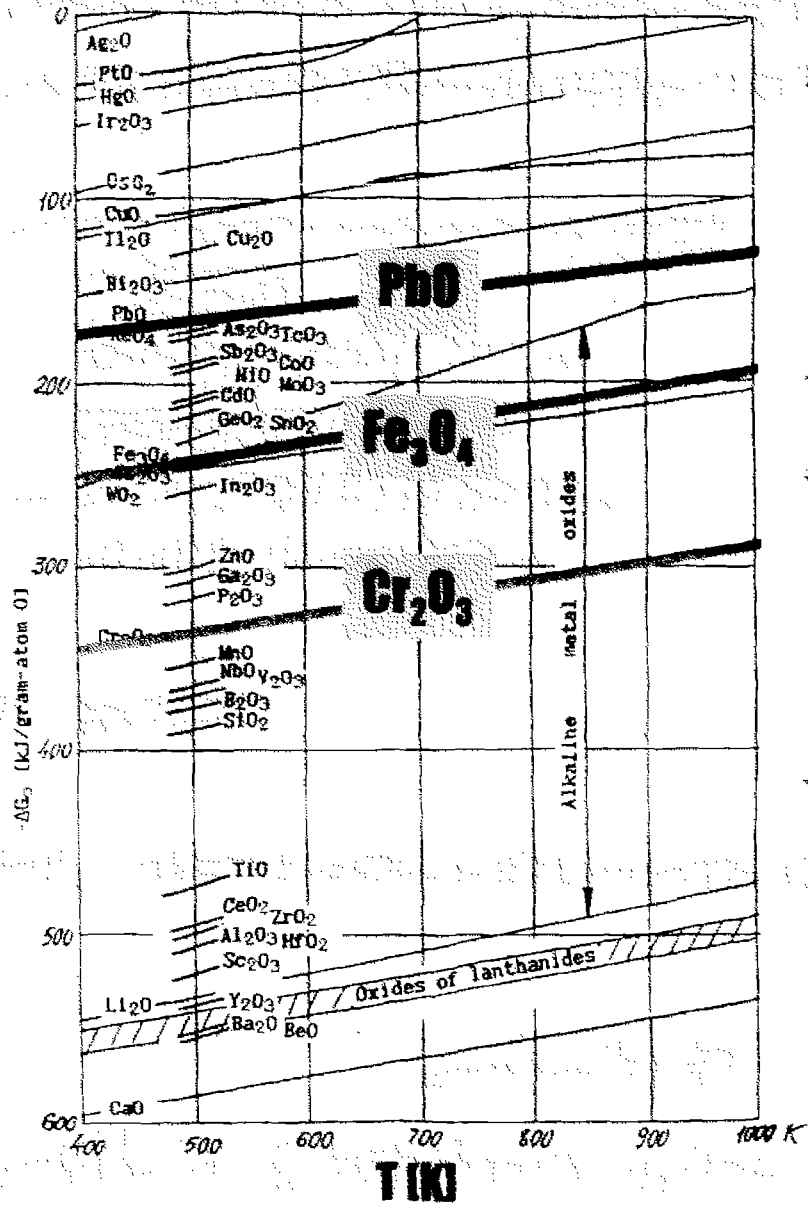

**(Elements unlikely to form oxides)**

**High O<sub>2</sub> Level: Lead Oxide Forms**



**Maintain O<sub>2</sub> Level here:**  
 - No Lead Oxide  
 - Forming Self-healing (FeCr)<sub>2</sub>O<sub>4</sub> Film

**Low O<sub>2</sub> Level: No Oxide Film**



**(Elements form oxides easily)**

Fig. Standard free energy change for the oxide formation reactions.

# ***Effects of Spallation Products on Oxygen Level Control Are Minor***

**Spallation products mass in LBE target in LANSCE beam after 1 year**

<b>Group</b>	<b>Elements</b>	<b>Mass of Elements (g)</b>	<b>Mass of Oxide (g)</b>
<b><math>\Delta G</math></b>			
<b>&gt; Pb</b>	<b>Au, Ag, Pt, Os, Cu, Ti, Pb, Bi</b>	<b>110</b>	<b>(none)</b>
<b>Pb&gt;-&gt;Fe</b>	<b>Re, As, To, Sb, Co, Ni, Mo, Sn, Fe</b>	<b>1</b>	<b>1.3</b>
<b>&lt; Fe</b>	<b>Lanthanides, Halogens, Alkaline Elements, Be, Y, Sc, Al, Ge, Ti, Hf</b>	<b>11</b>	<b>14</b>

**Results from Gromov, Orlov, and Gylenvsky, IPPE, Obninsk**

**Only a small mass of elements which oxidize preferentially to Fe are formed  
Oxygen level needs to be adjusted only if it falls below permissible range**

## ***Summary of Part I***

- (1) We have established framework for complete neutronic, thermal hydraulic and structural analysis**
- (2) We are in close interaction with IPPE target design and construction team**
- (3) Analysis shows preliminary design very promising**
- (4) Final target design is expected in October, 1998**

## ***Part II.***

# ***Polonium Removal Technology***

**LANL/IPPE Contract: Develop a polonium removal device in LBE coolant systems for ATW**

**Objective: Mitigate a radiological safety concern of polonium release hazard**

**Task Plan(5-year):**

- select most feasible technology for polonium removal (96-98)**
- restore coolant quality after removal(97-99)**
- removal system design and safety analysis (2000-2003)**

# Origin of Polonium in Lead-Bismuth Target

- A)  $\text{Bi}^{209} (n, \gamma) \text{Bi}^{210} \rightarrow \text{Po}^{210}$  (main mechanism)
- B)  $\text{Bi}^{209} (p, xn) \text{Po}^{210-x}$ ,  $x = 1-12$
- C)  $\text{Pb}^{208} (\alpha, xn) \text{Po}^{210-x+2}$ ,  $x = 2-14$  (not important)

## Activity of Po Nuclides After 1-yr. Operation (LBE: 15MW, 1 GeV) at Shutdown

Nuclide	Half-life, days	$\alpha$ - particle yield per disintegration, %	Activity, Ci
Po-210	1.384 E+02	100	2.310 E+04
Po-209	3.726 E+04	99.74	3.610 E+01
Po-208	1.058 E+03	100	2.570 E+03
Po-207	2.429 E-01	0.02	1.724 E+04
Po-206	8.800 E+00	5.45	1.902 E+04
Po-205	7.500 E-02	0.04	1.420 E+04
Po-204	1.471 E-01	0.66	1.376 E+04
Po-203	2.549 E-02	0.11	7.700 E+03
Po-202	3.104 E-02	2	5.465 E+03
Po-201	1.062 E-02	1.6	2.853 E+03
Po-200	7.986 E-03	15	8.510 E+02

# ***Polonium Hazard and Regulations***

- Hazard: Release from active coolant in the events of circuit breakdown (e.g. repair, accidents) and consequent gas-aerosol and surface activity formation
  - Regulations: Limit permissible concentration (LPC) of Po-210 in air for professionals\*
    - Russian (NRB-76/87):  
 **$0.93 \times 10^{-13}$  Ci/l**
    - US (Federal Register of 5/21/91 Vol 56 #98)  
 **$3 \times 10^{-13}$  Ci/l**
- (\*: LPC for Po-209 and -208 were not established but should be about the same)

• Russian experience: proper radiological safety measures were deployed and no noticeable personnel exposure to Po in over 70 reactor-year NPP experience even without Po extraction

# Polonium Release Rates from Active Coolant

- Po mainly exists as PbPo
- Evaporation under vacuum (Into gas atmosphere under normal pressure: ~1000 times slower)

**Evaporation Rate of Polonium from LBE**  
(Ci/m<sup>2</sup>s)/(Ci/kg)

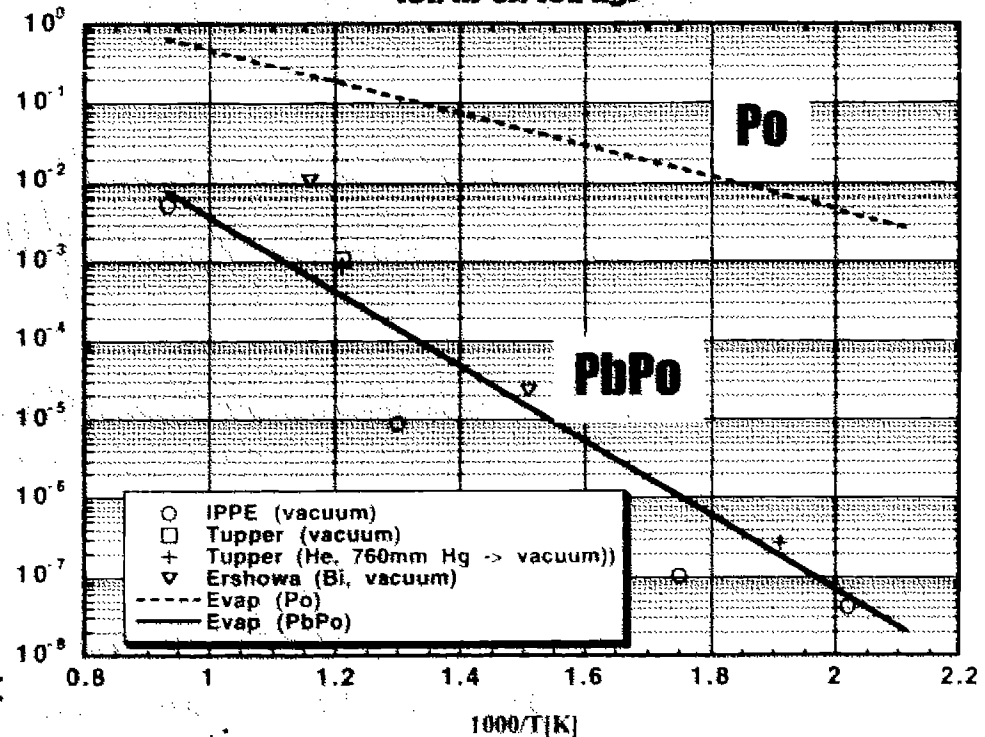

- Under contact with moist air:
  - Main channel is not PbPo evaporation
  - but gaseous volatile Po hydride formation
$$\text{PbPo} + \text{H}_2\text{O} \rightarrow \text{H}_2\text{Po} + \text{PbO}$$
- release rate at 20°C (experiments and real accidents)

$$q \sim 1.5 \times 10^{-9} \text{ (Ci/s)/Ci}$$



# ***Polonium Removal Methods Based on Russian Experience***

- Vacuum sublimation
  - Po removal by evaporation when coolant is heated up to 700°C
  - Used for military applications, but not well suited for ATW
- Alkaline extraction
  - Contact coolant with alkaline melt (reversible reaction)  
$$\text{PbPo} + 4\text{NaOH} \leftrightarrow \text{Na}_2\text{Po} + \text{Na}_2\text{PbO}_2 + 2\text{H}_2\text{O}$$
  - IPPE experiments
    - 1) 90% Po transferred in 2 minutes of contact
    - 2) oxidizer in system caused Po back-transfer\*
  - Additional benefits of removing other spallation products
- Storage
  - Back transfer to LBE or Pb from alkaline melt by adding oxidizer
  - 50,000 Ci in 100 l of solid LBE with natural convection cooling only

# Necessary Degree of Polonium Removal

Without cleaning

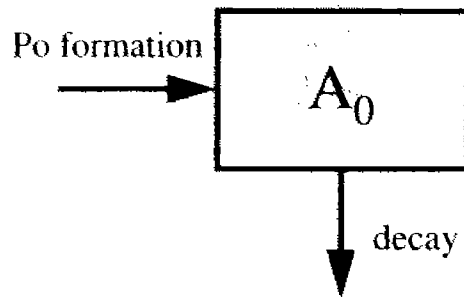

With cleaning

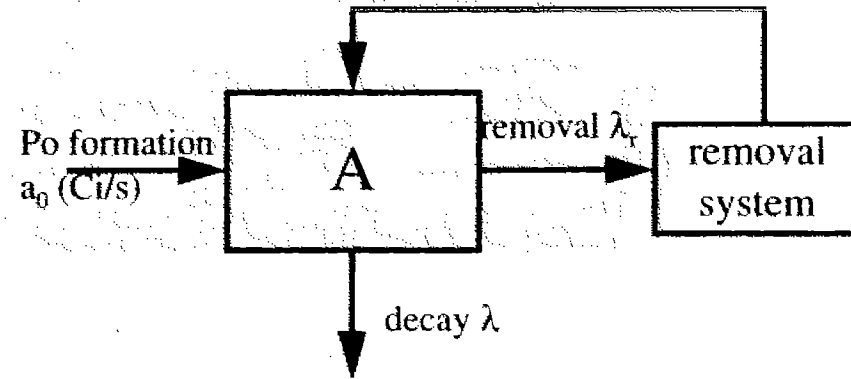

Removal degree:  $K = A_0/A$

- 15MW LBE Target (1 yr.): Po specific activity  $a_0 \sim 30\text{Ci/l}$
- Based on consideration of some accidents:  $a \sim 0.03\text{ Ci/l}$  -> gas aerosol activity  $\sim 10^{-14}\text{ Ci/l}$  (0.1 Russian LPC; 0.03 US LPC)

$$K = 1000$$

$$\lambda_r = (K-1) \lambda \sim K \lambda$$

For Po-210,  $K=1000$ ,  $a_0 = 1.6\text{E-}3\text{ Ci/s}$ ,  $\lambda = 5.8\text{E-}8\text{ s}^{-1}$

$$\lambda_r = 5.8\text{E-}5\text{ s}^{-1}$$

# ***Efficiency of Po Removal Systems***

Alkaline extraction:  $\lambda_r = g \epsilon / G$

$g$  - flow rate of the bypass coolant for extraction, kg/s

$\epsilon$  - fraction of Po transferred to alkaline,  $\sim 0.9$  in 2 min.

$G$  - total coolant mass

Case: 15 MW LBE target,  $G = 10^4$  kg

$g = \lambda_r G = 0.6$  kg/s

In the target loop:  $g_0 = 600$  kg/s, so  $g = 0.1\% g_0$

$\epsilon = 0.9$ ;  $\tau \sim 2$  min. for contact of coolant and alkaline

$G_e = g\tau \sim 70$  kg

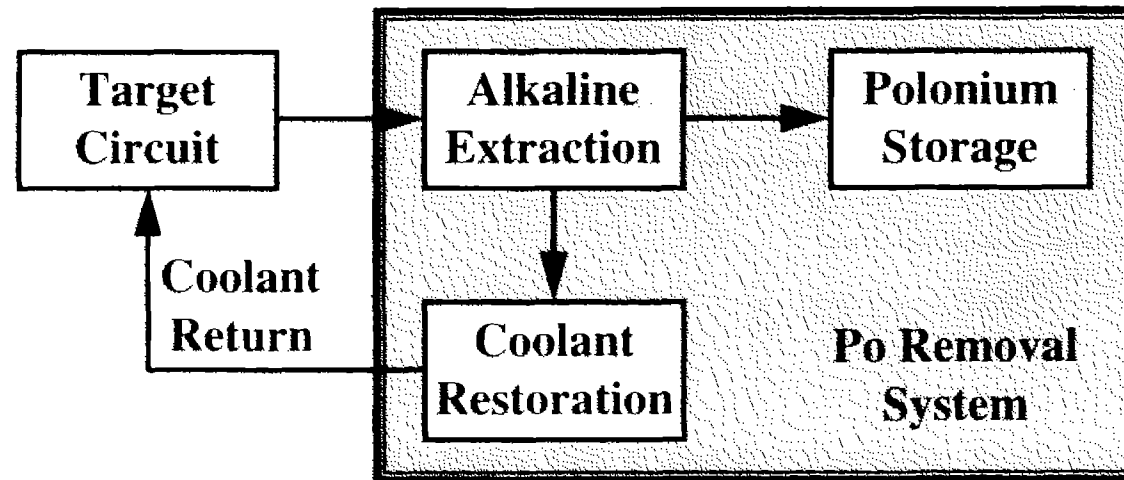

## ***Summary of Part II***

- $\alpha$ -active Po presents gas-aerosol release hazards
- Po exists as PbPo in LBE and evaporates much slower than Po
- Russian NPP experience shows no noticeable Po exposure in over 70 reactor-years and strongly indicates that Po hazards are controllable
- Alkaline extraction of Po is feasible and can also extract other spallation products
- Coolant restoration is needed after alkaline extraction
- In 5-yr plan: Po removal system design and safety analysis

# ***Los Alamos Liquid Lead Bismuth Eutectic (LBE) Test Loop***

Los Alamos National Laboratory  
**- ATW Project -**

**Presented by: Keith Woloshun**

LANL: N. Li, J. King, R. Hammer, V. Tcharnotskaia, T. Langston  
W. Teasdale, and S. Wender  
IPPE: Y. Orlov

# ***Outline***

- Test loop objectives
- Test loop description
- Safety measures
- Operating experience to date
- Test plans
- Summary

## ***LBE Test Loop Objectives***

- Collaborate with Russian experts for technology transfer to establish the knowledge and experience bases in U.S. for designing and operating LBE systems for ATW
- Conduct thermohydraulic and material verification experiments critical to ATW system designs

# Los Alamos Liquid-LBE Loop for Thermohydraulic and Material Experiments

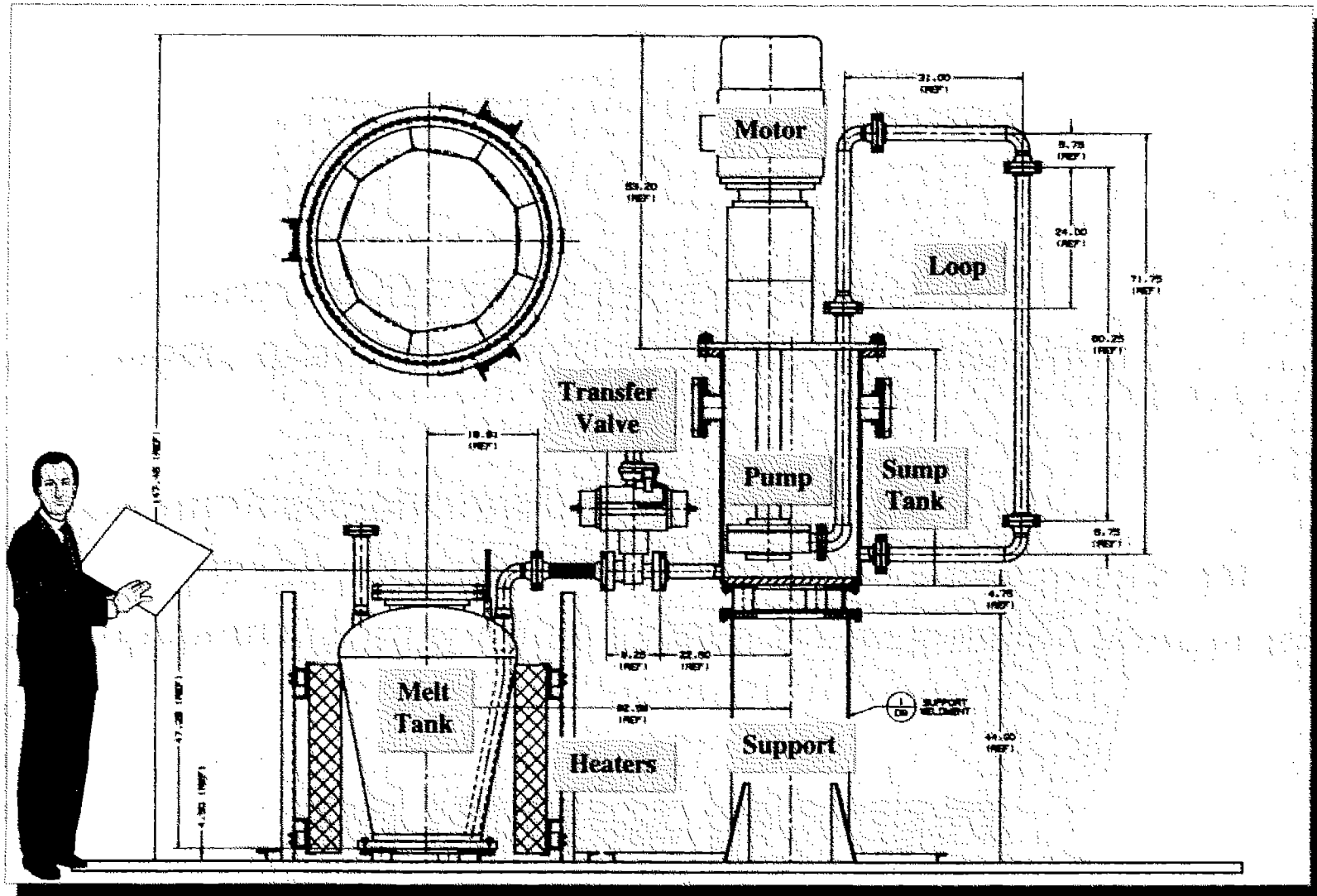



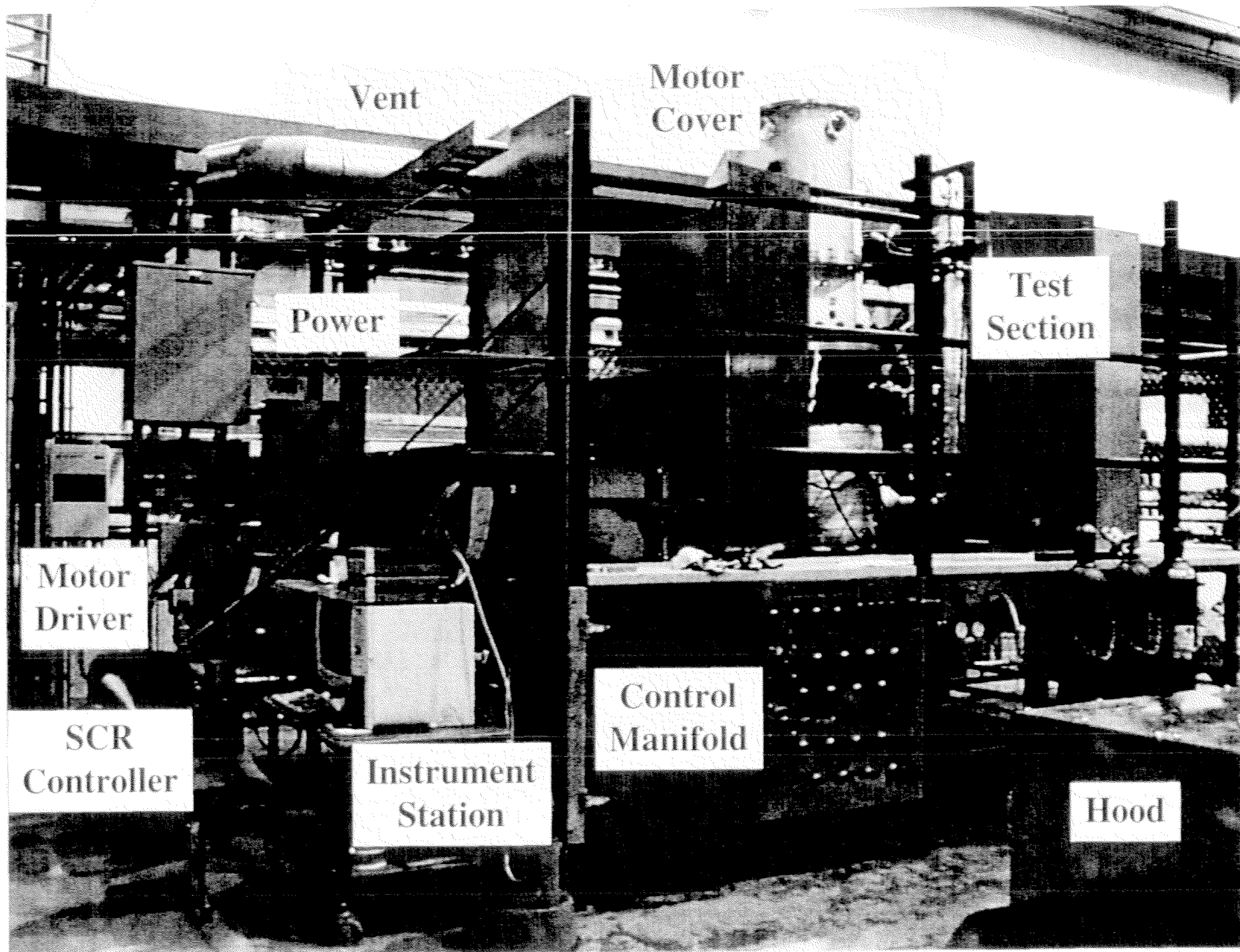

Vent

Motor  
Cover

Power

Test  
Section

Motor  
Driver

SCR  
Controller

Instrument  
Station

Control  
Manifold

Hood

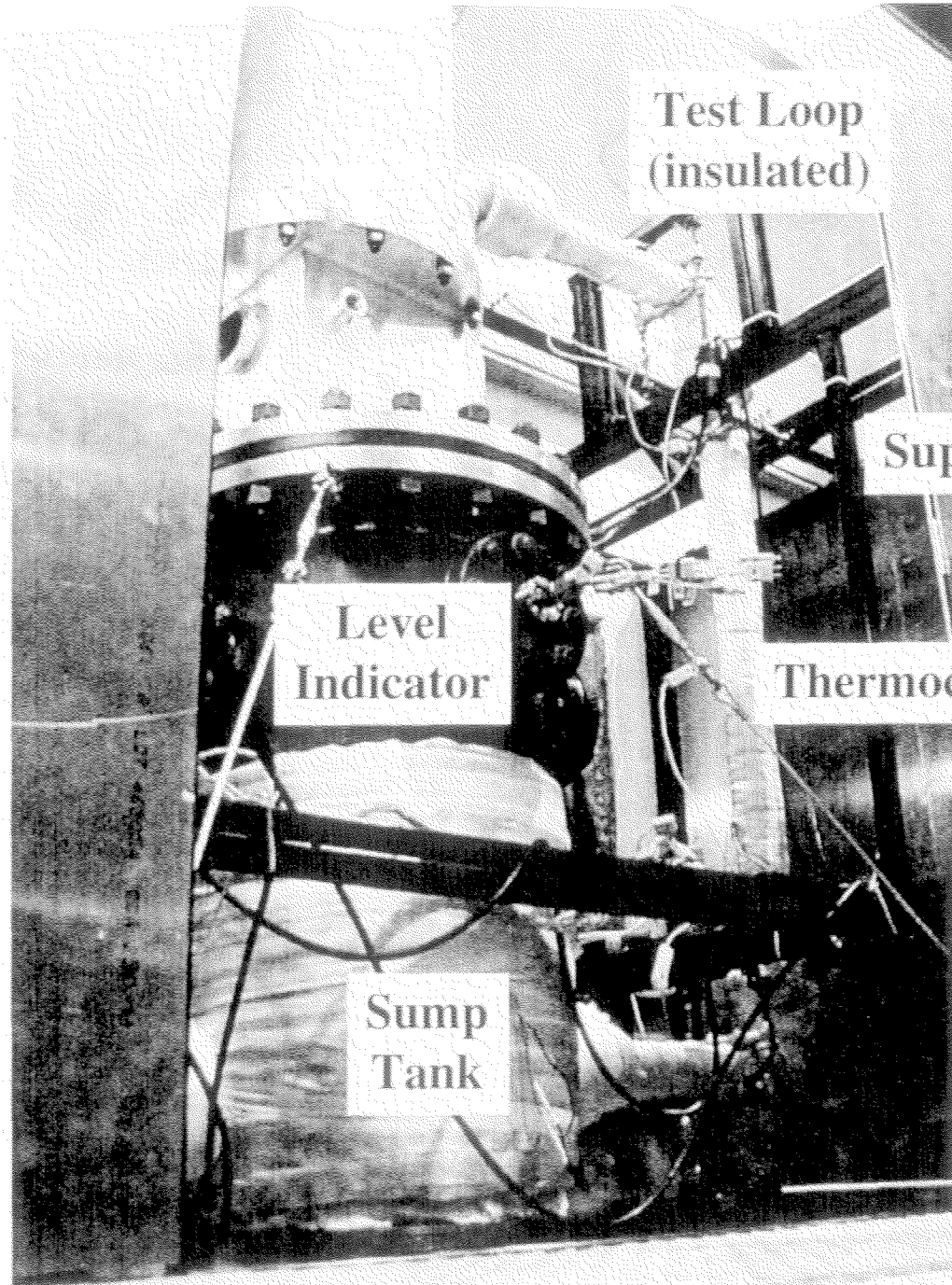

Test Loop  
(insulated)

Support

Level  
Indicator

Thermocouples

Sump  
Tank

# ***System Analysis and Safety Measures***

We systematically analyzed system safety and implemented mitigating measures:

- Lead hazard - well below OSHA limit( $50 \mu\text{g}/\text{m}^3$  in air/8-hr); vented
- Pressurized vessel hazard - within vessel design spec; relieve valves
- Electrical, mechanical, high temperature hazards - access control
- Waste hazard - standard Laboratory disposition procedures

The results are documented in

- “Molten Lead-Bismuth Flowing Test Loop Description, Operating Procedures, Safety Analysis”
- Special Work Permit (SWP) for initial startup operation

## ***Loop Successfully Started and Operated***

- Test loop operated on 2 occasions for ~ 4 hours at 33% to 100% pump power, nominally 67% at 250°C
- Estimated over 3.5 m/s LBE flow velocity in 2" ID loop
- Noise and vibration very low with adequate sump pressure
- No LBE leaks through valve or seals
- Level indicators worked

# ***Existing LBE Test Loops in IPPE and LANL***

<i>IPPE Facility</i>	<i>Research field</i>	<i>Coolant</i>	<i>Temperature (°C)</i>	<i>Coolant flow rate (m<sup>3</sup>/h)</i>	<i>Coolant volume (m<sup>3</sup>)</i>
CBT-3M	Thermo-hydraulics	Pb-Bi	160-450	20	0.1
ICP	Corrosion	Pb Pb-Bi	160-650	6	0.1
TT-1M	Corrosion	Pb-Bi	240-600	6.5	0.18
TT-2M	Mass transfer	Pb-Bi	270-650	5	0.2
CM-1	Corrosion Mass transfer	Pb-Bi	270-650	2.5	0.1
CU-2M	Corrosion Mass transfer	Pb-Bi	270-650	2	0.1
LANL Test Loop*	Thermo-hydraulics	Pb-Bi	150-450	22	0.24

\*: Only one in U.S.

## ***LBE Test Plan (5-year)***

- Expand instrumentation and controls
- Test thermohydraulics of critical components necessary for ATW designs: target window design, pumps, heat exchangers, fuel elements, etc., necessary for ATW designs
- Circulation hydraulics and natural convection experiments
- Material verification experiments

## ***Summary***

- Test loop has been started
- Safety issues have been recognized and adequately addressed
- Full instrumentation and control will be implemented in the next three months
- Collaborations with Russian experts have contributed to our early successes

# ***ATW Program Plan and Summary***

*Francesco Venneri  
ATW Project Leader*

***Los Alamos National Laboratory  
-- ATW Project --***



# ***ATW Development Path***

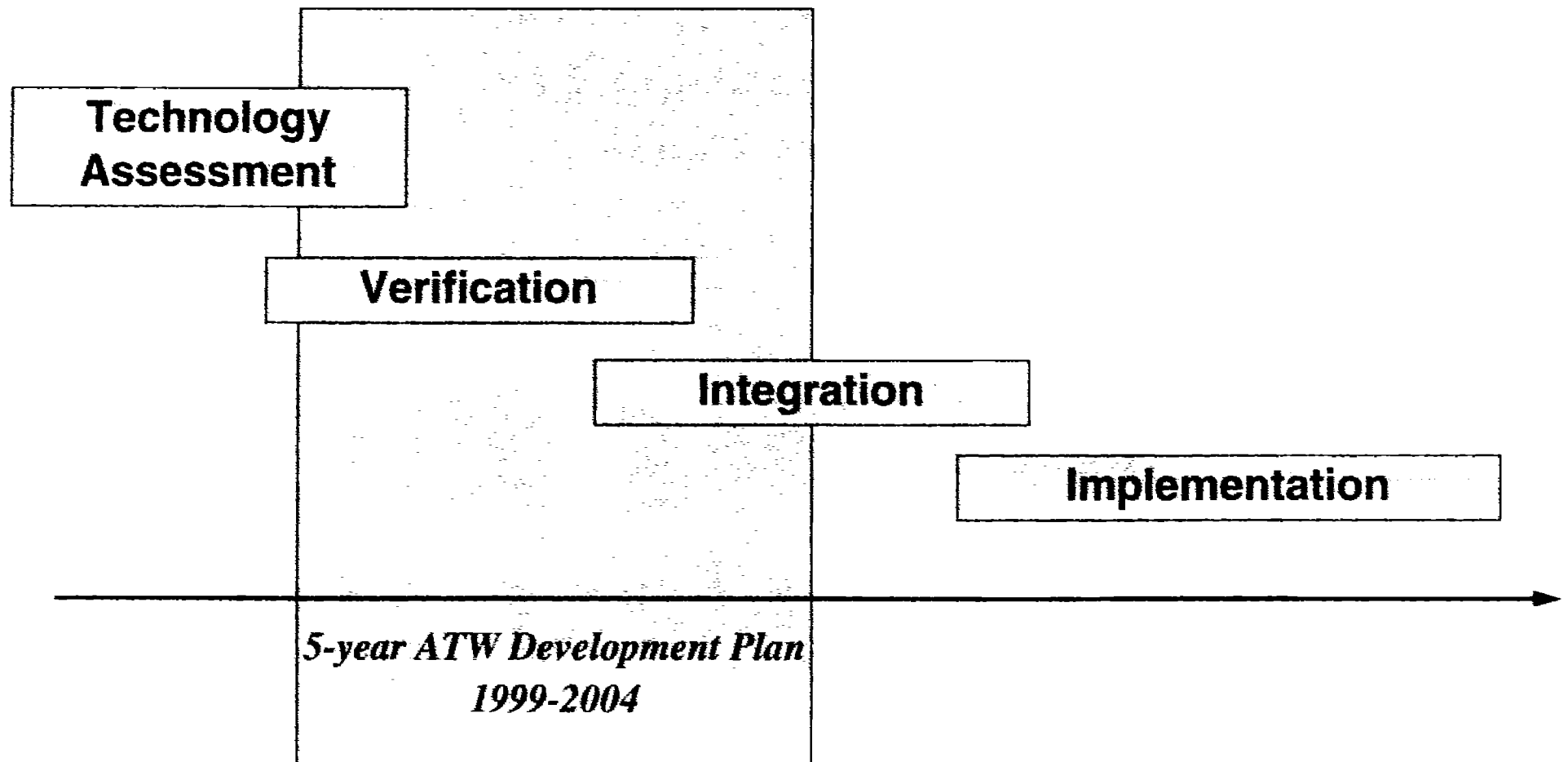

# ATW Development Road Map

where we are, 1998:  
**Technology Assessment**

- *Accelerator technology*  
status: APT-driven, ATW specific features could be developed from APT
- *Liquid lead technology*  
status: early stage in US, Russian technology fully developed
- *Pyrochemistry*  
status: individual parts well developed, Argonne and LANL have expertise

**5-year Development Plan**  
**Technology Verification and Small-scale Integration**

- *Nuclear design*
- *Integrated small scale waste treatment plant*
- *Fuel development*
- *Russian liquid lead technology transfer*
- *High power spallation targets*
- *Materials verification*
- *ATW-specific accelerator design*

where we are going:  
**Large scale Integration and Implementation**

**ATW Subcritical Testbed Facility (STF) at LANL**  
**10-50 MW thermal power**

**ATW Process Facility (APF)**  
**>100 kg scale**

**DEMONSTRATION of Accelerator-driven Waste Transmutation system**  
**10-20 MW beam**  
**500-1000 MWh**

1999

2004

Decision based on completion of:  
Materials selection, Component Performance verification, STF Preconceptual Design, APF Design, DEMO Point Design

Five-year ATW development plan provides technology support for large-scale integration and deployment

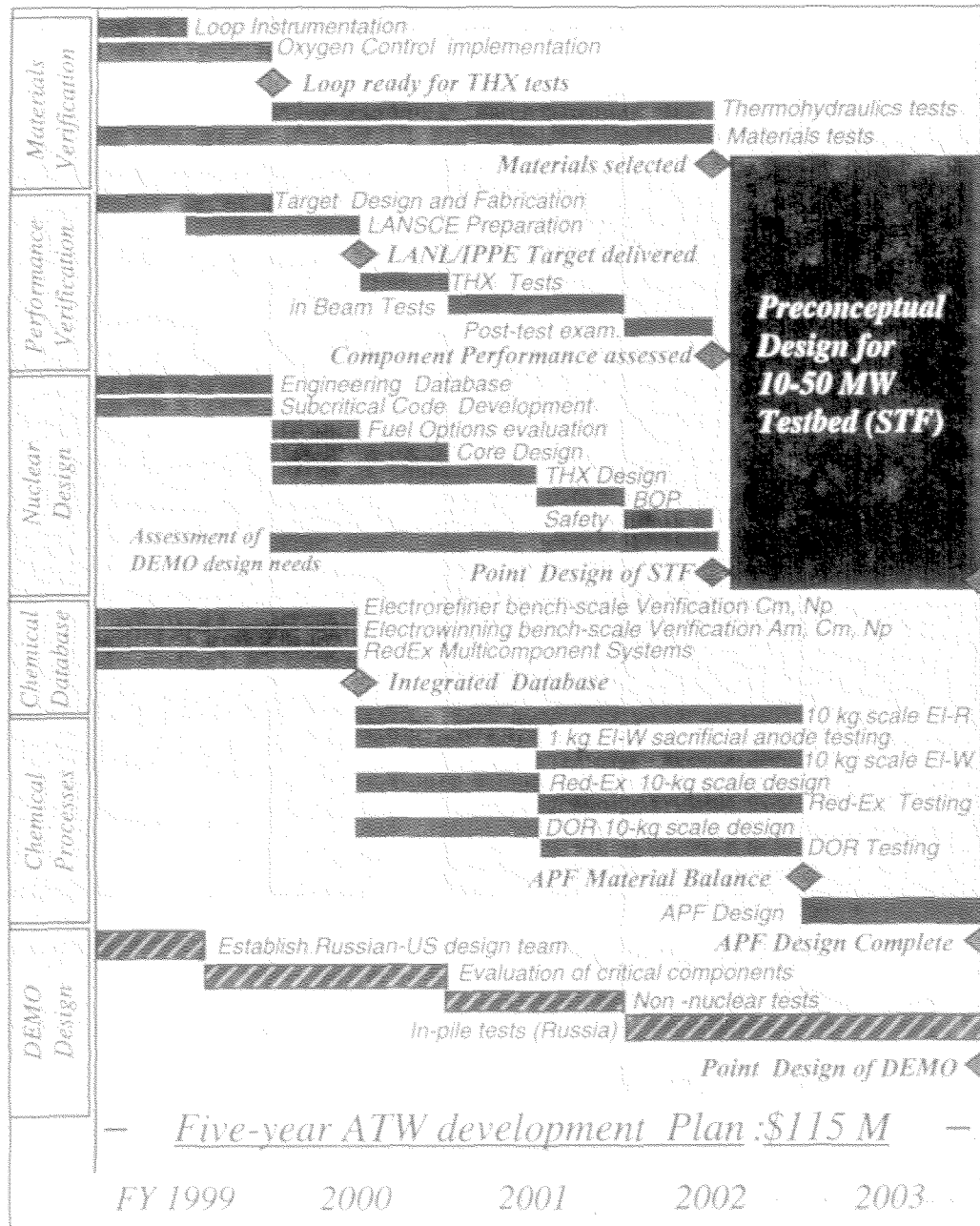

**Design, construction and initial operation of 10-50 MW Subcritical Testbed Facility (STF) at LANL**

- ATW fuel tests
- Test of components
- Integrated operation
- Neutron source
- Transmutation experiments

**Continuing STF operation at LANL**

**Construction and operation of 100-kg scale ATW Processing Facility (APF)**

- Test of components
- Integrated operation

**Preconceptual Design of ATW DEMO**

**ATW DEMO Design, Construction 500-1000 MW**

2004    2005    2006    2007    2008    2009    2010    2011    2012    2013    2014    2015

# Preconceptual Design for 10-50 MW Testbed at Los Alamos

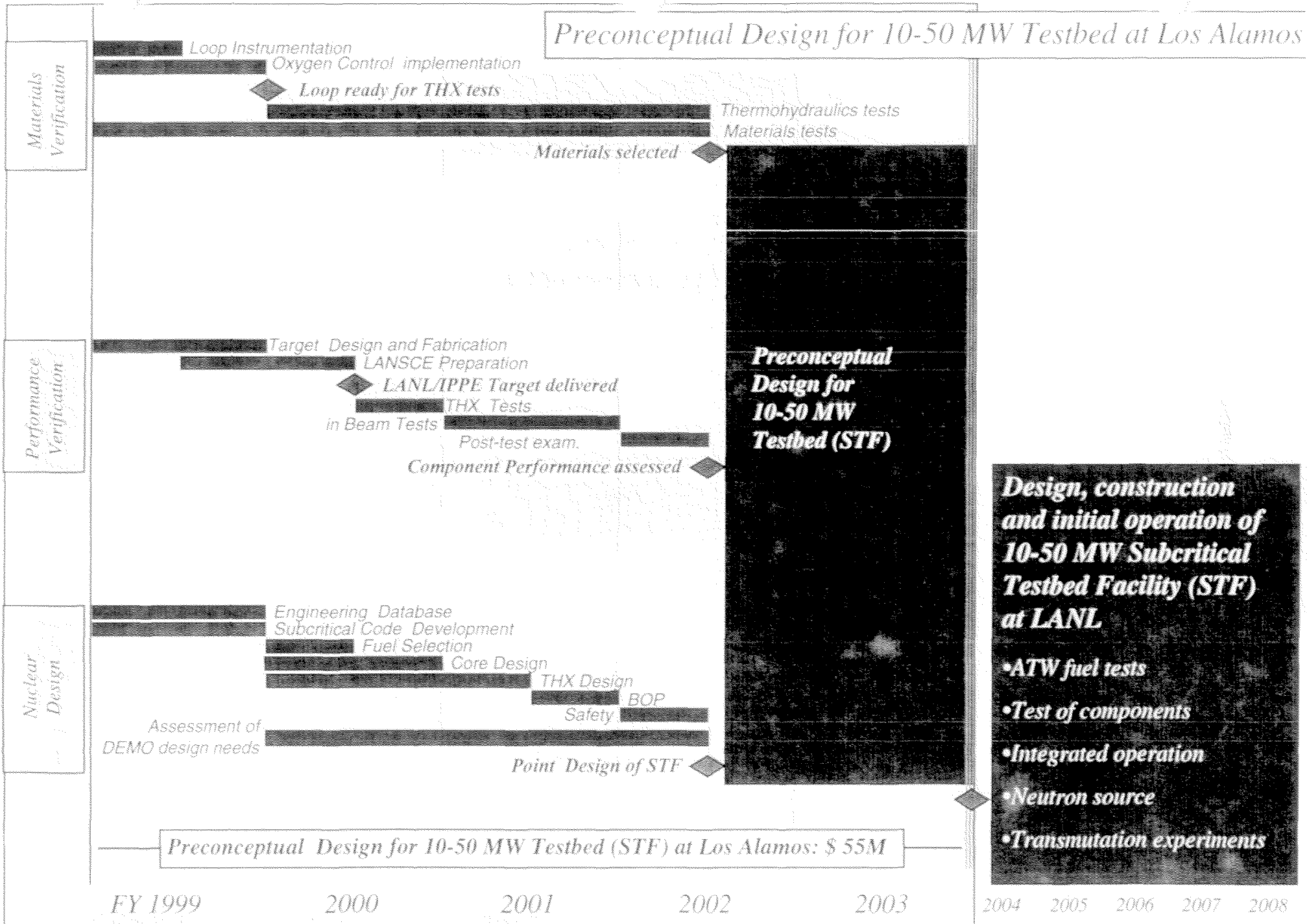

***"Reducing the Impact of Nuclear Waste"***

# ***SUMMARY***

Francesco Venneri  
ATW Project Leader

***Los Alamos National Laboratory***  
***-- ATW Project --***

# ***Performance Drivers in the ATW concept design :***

## ***Fast Burn Rates, Low Inventories***

*Capability for rapid materials inventory reduction*

*Minimized economic impact*

## ***Safety***

*Engineering design clarity, defense in depth.*

*inherent safety*

## ***Proliferation Resistance, Low Environmental Impact***

# ATW Consists of Three Major Functional Blocks

**Accelerator**  
APT  
Technology

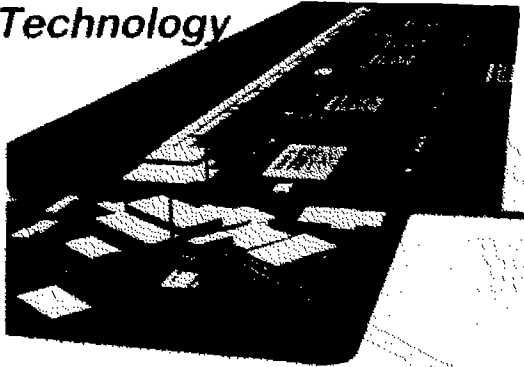

**Pyrochemical Processes**

*Proliferation resistant, low environmental impact*

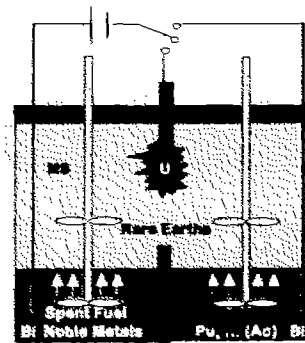

**Spent Fuel**

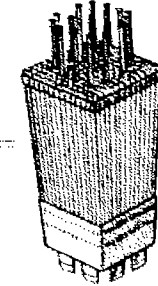

**Subcritical Burner**  
(multiple units)

*Liquid Lead Nuclear Technology*

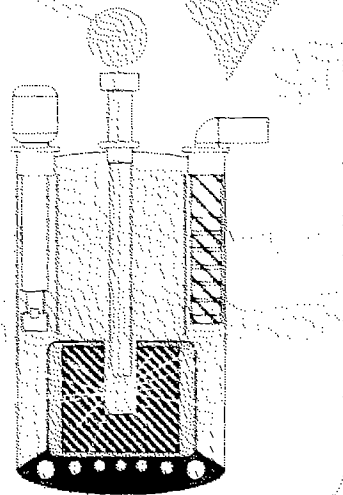

**Power Production**

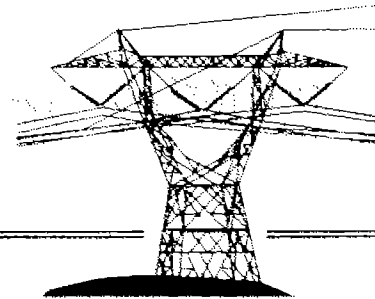

**Residual Waste to Repository**

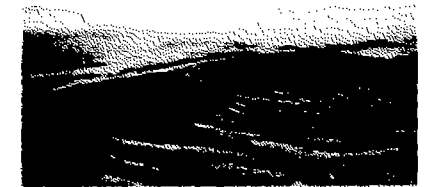

**Power to Grid:**  
~ 90%

**Power to Accelerator:** ~10%

## ***ATW Technology***

### ***what does the accelerator buy?***

#### *Subcriticality*

- ***Power control not linked to reactivity feedbacks, delayed neutrons or to control rods, but only to the accelerator drive***
- ***Constant power during burnup achieved by variable beam power***
- ***Pure transuranic cores, CR=0: ATW has no need for fertile materials***
- ***Subcritical systems work independently of the fuel composition***
- ***EOL inventory not limited by criticality. EOL burndown of inventory***
- ***Neutronics and thermohydraulics are effectively decoupled***



## ***ATW Technology***

### ***what does liquid lead-bismuth buy?***

- **Design simplicity:** no separate target structure
- **Good spallation source:** possibly the best n/p outside actinides
- **Enhanced safety:** large natural convection capability,  
no reaction with water or air
- **Good neutronics:** very hard spectrum, very low neutron capture,  
negative temperature and void coefficient
- **Good thermal hydraulics:** large  $\Delta t$ , low operating pressure, very high  
boiling temperature

## ***ATW Technology***

### ***what does pyrochemistry buy ?***

- **PYROCHEMISTRY ALLOWS FAST, BULK-TYPE SEPARATIONS:  
what is needed in ATW, no more**
- **High Level of Proliferation resistance**
- **IT IS NOT ADVERSELY AFFECTED BY HEAT OR RADIATION**
- **IT PRODUCES LOW AMOUNTS OF SECONDARY WASTE**
- **Could be less expensive than traditional aqueous chemistry**

# Minimized-RISK APPROACH for ATW DEVELOPMENT

	Beam Power	Fission Power	Power Density	Fuel Type	Neutron Flux	Chemistry
<b>LANL-IPPE Target (1999 - 2001)</b> <i>no fissionable material. Competency development. High radiation environ. Window testing. TH stressed</i>	1 MW	---	500 w/cc	---	>10**13	Oxygen control
<b>Subcritical testbed (2001-2010)</b> <i>Limited fissionable inventory. Could use LANSCE. TRU fuel development + test.</i>	1-2 MW	10-50 MW 0.75-0.9 keff	100 w/cc	UO <sub>2</sub> (20% enr.) metal fuel test	>10**14	Po removal Oxygen control
<b>ATW demonstration (2007 - )</b> <i>Conservative approach. Forgoing Operation. Could be at SRS/APT. Chemistry, FP transmutation., full TH</i>	10 - 20 MW	500-1000 MW 0.95 keff	100 w/cc	metal fuel U - TRU core	>10**15	fully integrated waste treatment +transmutation
<b>ATW full size burner (2015 - )</b> <i>Full TRU destruction performance. Accelerator load following, extend, burn.</i>	20 - 40 MW	2000 MW 0.97-0.93 keff	350 w/cc	metal fuel full TRU core	>10**15	fully integrated waste treatment +transmutation

## ***PCAST Energy R&D Recommendations for Nuclear Fission:***

- **Proliferation-resistant reactors or fuel cycles**
  - **New reactor designs with higher efficiency, lower cost and improved safety**
  - **Low-power, inexpensive reactors**
  - **New techniques for on-site and surface storage and for permanent disposal of nuclear wastes**
- 

***Pyrochemistry, Subcriticality and Liquid Lead/LBE technologies are not restricted to ATW applications***

***Most development work done / planned for ATW is directly applicable to systems (critical and subcritical) and fuel cycles that respond to all the PCAST recommendations***

# ***ATW can provide a technological bridge to a sustainable US Nuclear Future***

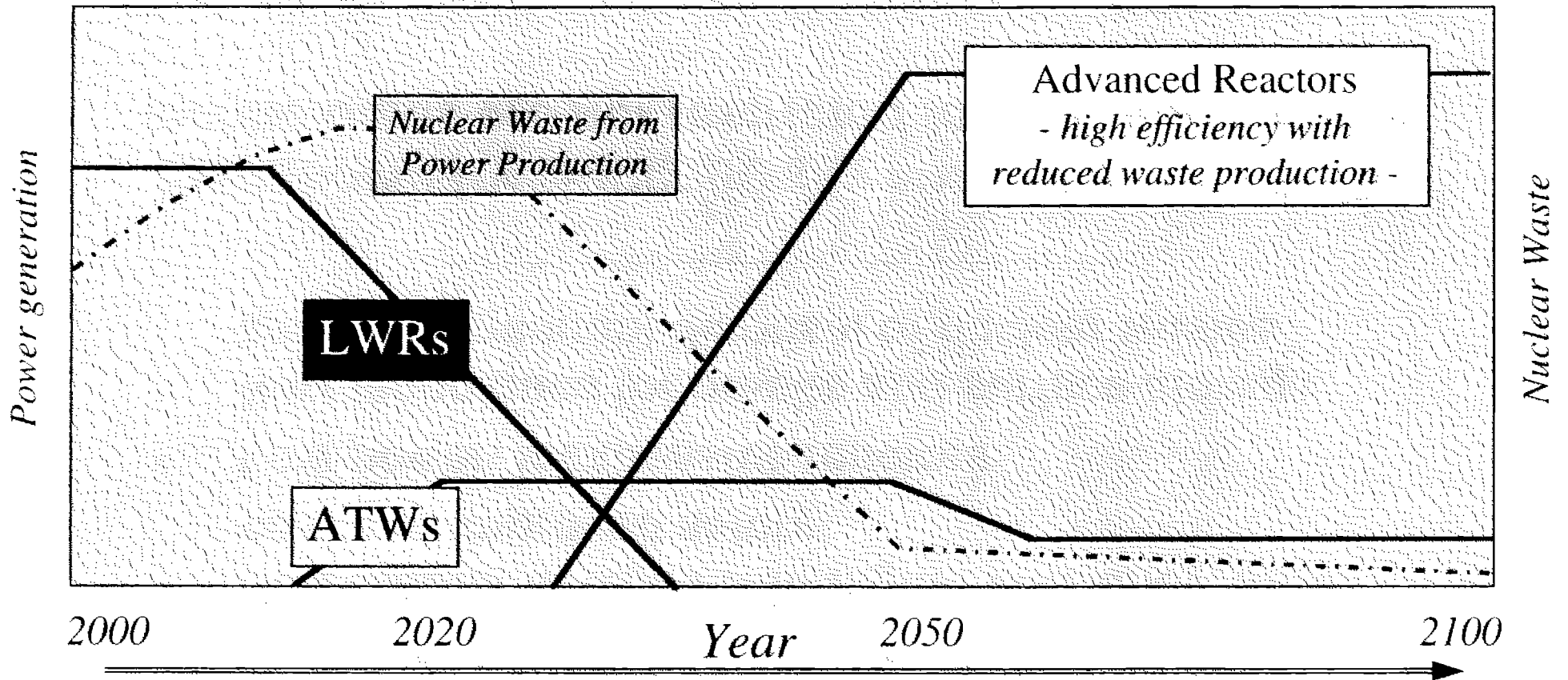

*past the burnup of the present backlog, ATW's can help sustain a viable nuclear energy strategy*

# ***Concluding remarks***

**ATW can positively affect US waste management by assisting the Repository meet its objectives.**

**The ability to demonstrate such a means of waste destruction will be very important in fostering the confidence that a "forever" legacy of waste is not the unavoidable consequence of having once used nuclear power.**

**ATW systems could be used in a series of different scenarios, including the expanded, sustained or declining use of nuclear power. ATW technology is relevant to new and attractive nuclear designs and options.**

***... 5-year Program is Crucial***

To the ATW Review Panel,

In the following discussion, we address some of the points raised during the feedback session shortly after completion of the Review presentations.

1. Energy Multiplication
2. Liquid fuels
3. Breakdown of ATW waste to repository
4. Typical neutron spectrum
5. Extraction and transmutation of iodine

We invite and welcome further questions, as look over and evaluate the material that was presented.

Francesco Venneri and the ATW team

# 1. Energy Multiplication -- How large a proton beam is necessary to drive a certain fission power in a subcritical multiplying assembly.

Starting from a basic point model

$$(1) \quad m=1/(1-k)$$

where m is the neutron multiplication of a system, one arrives to the relation

$$(2) \quad PF=PB*6k/((n)*(1-k))$$

where PF is fission power of the multiplying blanket, PB is power of the driving beam, k is keff of the blanket, and n is the average neutron production per fission. 30 neutrons per GeV proton are assumed (contained in the factor 6 at the numerator).

This would be the correct way to look at the problem of a system driven by a uniformly distributed source, where all source neutrons have the same chance at leakage as the fission neutrons.

However, this is not the case for systems driven by a centrally located neutron source, such as ATW. Here all chains start at the center and the source neutrons have a lower chance to escape or being otherwise lost, if the target/blanket is properly designed. The key to proper design for subcritical source-driven systems is to skew the loss-to-fission ratio as much as possible in favor of the source neutrons compared to the subsequent fission neutrons.

The energy multiplication is therefore strongly dependent on the specific design (geometry and fuel distribution) and a simple relation is possible only for very simplified geometries. One such geometry is the point source in a multiplying cylinder. Performing simple MCNP calculations on a typical ATW geometry (2m high, 3 m diameter, with a point source at the center, surrounded by 1 m of lead) leads to the following table:

Keff	fissions / source neutron F/N	fission energy / source neutron MeV/N	point source EM (MCNP) PF/PB	unif. source EM PF/PB
0.83400	2.7800	556.00	16.680	10.395
0.87900	4.1300	826.00	24.780	15.030
0.90100	5.3200	1064.0	31.920	18.830
0.92700	7.3300	1466.0	43.980	26.273
0.94900	10.890	2178.0	65.340	38.499
0.96400	16.990	3398.0	101.94	55.402
0.97700	28.650	5730.0	171.90	87.886

here we have varied the plutonium fraction in the simple core geometry to calculate Keff using MCNP (k-code). MCNP then calculates the number of fissions per source neutron: F/N (assumes neutrons generated in the center of the core), and the fission energy per source neutron (here reported in MeV/N, assuming 200 MeV per fission). The ratio of fission power to beam power (Energy Multiplication, EM=PF/PB) is then



calculated from the MCNP results assuming that 1 GeV proton produces 30 usable spallation neutrons in lead (Sunnyside experiments, and lots of LAHET MCNP calculations). Energy Multiplication is also evaluated, for the given Keff, using the formula given above (2) for the uniform source approximation.

#### Conclusions:

- The blanket power dependency on the target power (centrally located neutron source) depends crucially on how well the source neutrons are utilized. In a breeding design (such as Rubbia's), for instance, up to 40% of the source neutrons are captured in Thorium and do not directly contribute to the power of the blanket. Our systems (containing pure actinides) can achieve a more efficient target to blanket coupling, however appropriate design practices should be employed.
- A centrally located source will always couple to a subcritical system better than a uniformly distributed source, unless major mistakes are made in the design of the source/blanket. The two curves in the attached plot should be considered as delimiting the parameter space available to design optimization.

### Energy Multiplication (EM)

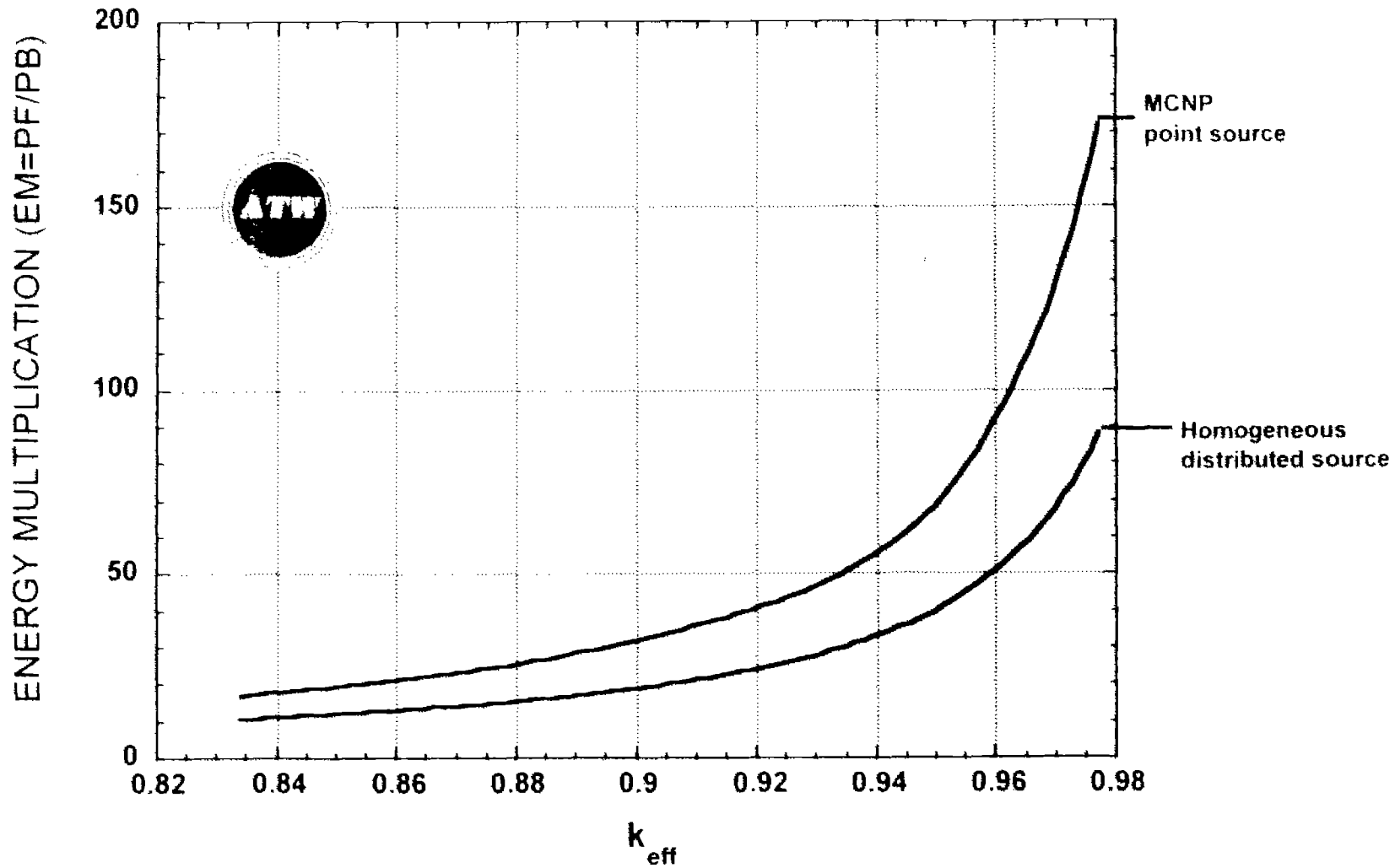

# Fraction of Flux Above a Given Energy for ATW Actinide Burner

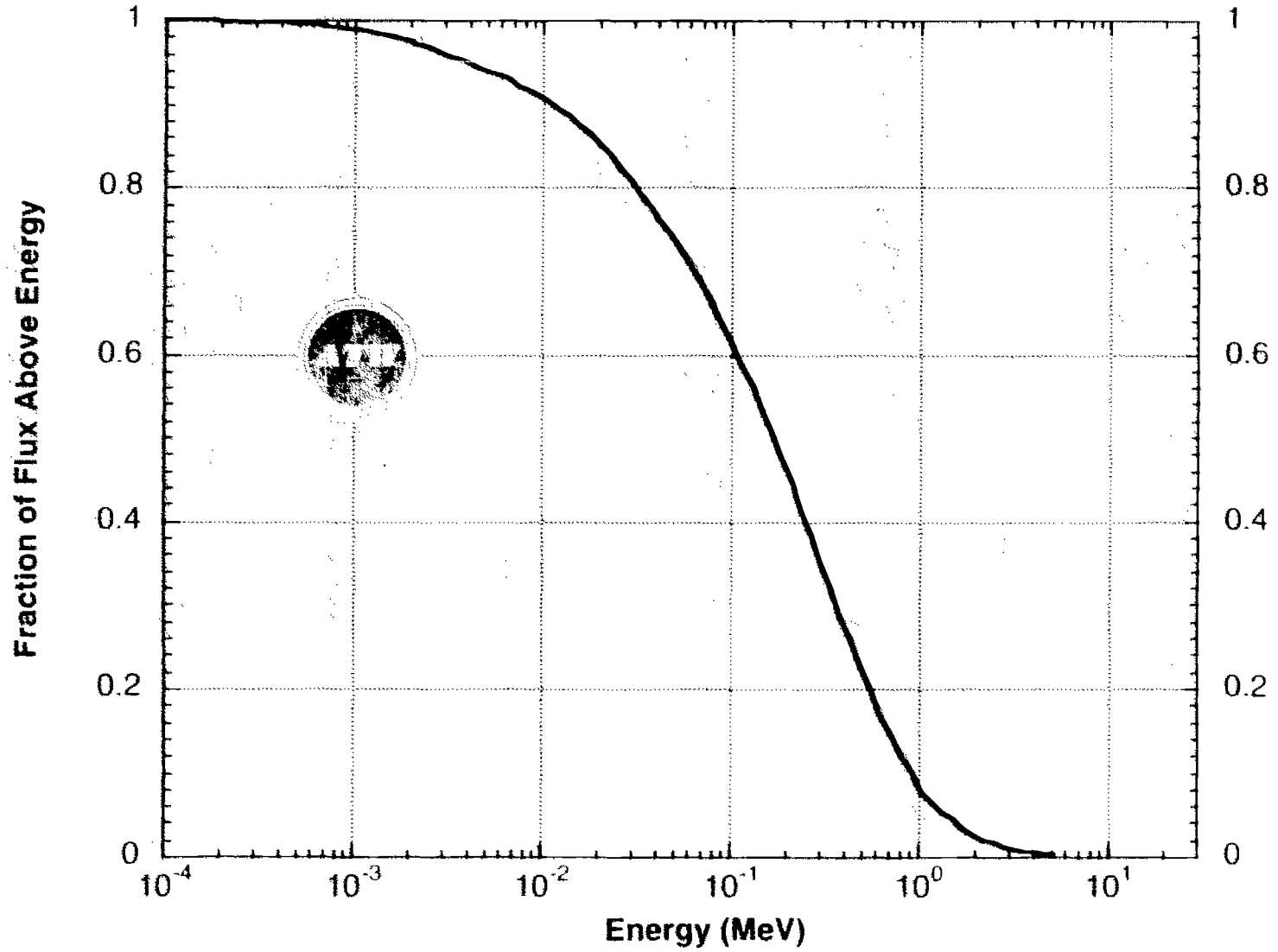

## 2. Liquid fuels

The point was raised at the Review of the possible use of liquid fuels in ATW systems.

We have looked at liquid fuels for a very long time. The first ATW concept proposed by Los Alamos used a heavy water slurry, with actinide oxides in suspension. We have also looked in depth at molten salt (fluorides) systems similar to the Oak Ridge MSR concept.

Liquid fuels, especially molten salts are very attractive from the point of view of neutronics, because they provide the means for continuous feeding of fissile material and extraction of the fission product poisons.

After extensive evaluation, we feel that the experience base for homogeneous liquid cores is too limited, and such choice for ATW, while attractive in the longer run, would require a much more substantial investment in research and development than the present one.

Among the issues that were raised and not answered to our satisfaction during the study:

- 1) the low melting point salts considered by Oak Ridge for their MSR concept contained beryllium fluoride, with only limited solubility for Plutonium and the higher actinides.
- 2) Many material problems still remain unsolved from the ORNL Program.
- 3) Inventory losses due to plating, evaporation and penetration in cracks.
- 4) On-line refuelling and cleaning.
- 5) Lack of clear fuel containment.
- 6) Large out of core inventories

Adopting solid fuels without fertile material, we face the inevitable consequence of having to compensate for burnup without the option of continuously replenishing the fissile content of the fuel. We pointed out a few ways: burnable poisons (including Technetium), movable absorbers, reflectors and source, variable beam current.

An interesting possibility to extend fuel burnup however, which we did not discuss in any depth at the Review, is the use of encapsulated "liquid" fuels. For instance sodium fluoride with actinide fluorides dissolved in it or lead with alloyed actinides. These fuels would be cast as clad solid fuel elements at room temperature. At operating conditions, however the fuel elements would be liquid.

The advantages of the concept are: no radiation induced swelling, uniform burnup, natural separation of volatile fission products, good match with the chemical processes. The disadvantages are: corrosion problems may be severe, clad rupture could lead to the dispersion of the fuel in the coolant (sodium fluoride based fuels however will freeze upon leaking).

In our 5-year program we plan to research the possibility of these encapsulated liquid fuels as an advanced alternative to the solid metallic fuel we presented at the Review.

### 3. Breakdown of ATW waste to repository

#### Waste Output to Repository

LWR Spent Fuel - 70000 t HM

700 t	rare earth oxide
910 t	noble metal oxide
370 t	gases (Xe and Kr)
315 t	active metal oxide in engineered storage (Cs, Sr, and Ba)
cladding / assembly hardware - the same as for the direct disposal option	
66937 t	HM
600 t	TRU to ATW
15 t	iodine to ATW
53 t	technetium to ATW

ATW Waste - 21000 t

180 t	rare earths in oxide form
230 t	noble metals in oxide form
5752 t	zirconium matrix from ATW fuel as oxide, assume no recycle
90 t	gases (Xe and Kr)
80 t	active metals in oxide form in engineered storage (Cs, Sr, Ba)
67 t	Ru metal from Tc transmutation (53 t - LWR, 16 t - ATW)
18 t	Xe from iodine transmutation (15 t - LWR, 4 t - ATW)
14400 t	cladding / hardware
80 t	spent salt from two chemical plants

Projected TRU output to the repository is <300 kg with the majority of the TRU contained in the noble metal oxide waste form.

#### **4. Typical neutron spectrum**

We enclose a typical spectrum for the liquid lead-cooled actinide burners. We are preparing more detailed spectra for the DEMO and FULL-SIZE geometries. We will submit these as soon as they are ready.

## 5. Extraction and transmutation of iodine

### Iodine Recovery

Iodine is one of the two long-lived radioactive elements, the other is technetium, identified for transmutation in the ATW system. In a PWR spent nuclear fuel assembly there is approximately 86 g of iodine dissolved in 455 kg of heavy metal oxide. Iodine is released from the spent fuel matrix in two processes; spent fuel decladding and crushing (vugraph #1 of the chemistry presentation) and the direct oxide reduction and salt recycle process (vugraphs #2 and #8).

Data from Nuclear Chemical Engineering by Benedict et al. indicate that approximately one to two percent of the iodine is released during the decladding process. Iodine released in this process could be adsorbed in metal getter beds, perhaps silver impregnated zeolites or a transition metal alloy, and targets manufactured for transmutation.

The bulk of the iodine is released during the direct oxide reduction process. This process converts the metal oxide to metal (vugraph #2). Iodine is present in the calcium chloride molten salt as either calcium iodide or, because cesium and strontium are also present in the salt, cesium or strontium iodide. The concentration of iodine in the spent salt is approximately 42 ppm by weight. Spent salt from the direct oxide reduction process is not discarded but instead is treated by a two-step process and recycled (vugraph #8). First, a chlorine sparge process converts the calcium oxide to calcium chloride. Then an electrowinning process regenerates calcium metal from calcium chloride and the metal and salt are reused in the direct oxide reduction process. Iodine is released during the chlorine sparge process because of the difference in stability between the metal iodides and chlorides. Volatile iodine could be collected in a cryotrap and later alloyed, perhaps with a transition metal or rare earth alloy, and fabricated into targets for transmutation. The alloys should be stable at the operating temperature of the system and possess low vapor pressure. Candidate alloy materials include chromium and lanthanum. Chemical equilibria were verified using SOLGAS. Calculations indicate that sparging the molten salt for 2 hours with chlorine gas at a rate of 1.0 l/min would be required to remove the iodine from the salt. Complete removal of iodine from the spent molten salt is not necessary because the salt is recycled rather than discarded.

### Technetium

A typographical error is present on the vugraph describing the amount of Tc present in the 70000 t HM spent fuel inventory. We have listed 5.3 t of Tc instead of the correct number of 53 t of Tc.

To the ATW Review Panel,

In the following discussion, we address some further points raised after completion of the Review presentations.

1. Backlog Burndown Scenario
2. More accurate neutron spectrum information
3. Delayed neutron fraction and subcriticality
4. Pb-205 production and inventory

Francesco Venneri and the ATW team



## **1. Transmutation in 65 Years. (A spent fuel back-log burndown scenario)**

One of the viewgraphs presented at the meeting contained an error. The viewgraph illustrating the 65-year backlog burndown scenario had 20 ATW burners operating in staggered fashion for 65 years, with a forty year plant lifetime). The right number of plants is 23. We regret the error, however, this gives us a good opportunity to explain the scenario in some detail.

### **Why is the burndown scenario important?**

To us in the ATW project, a large part of the value of the ATW concept is that it will be very effective at achieving the "clean slate" of zero-waste backlog for nuclear power, while at the same time introducing or preserving essential nuclear technologies for the next generation of nuclear systems (the technology "BRIDGE"). We believe the "clean slate", or at least the capability to reach it in a reasonable amount of time is essential in establishing confidence in an expanded role for nuclear power production.

By the year 2015, there will be 70,000 tons of US spent fuel containing about 600 tons of plutonium and higher actinides requiring disposal. The ATW objective in the backlog burndown scenario is to treat the spent fuel backlog, destroy the transuranics and selected fission products, and prepare the resulting waste for permanent disposition in a geologic repository.

A number of ATW systems is brought on line to accomplish the objective over a 65 year period. Each ATW system consists of an accelerator (1 GeV, variable current 20-40 mA, pyrochemical plant (50 tons/year throughput) and a subcritical 2000 MWt LBE burner. Several of these ATW systems can be located together in one facility. To reduce transportation and other factors related to moving fuel assemblies, one could consider three facilities with up to 8 ATW systems at each location.

Of particular relevance is the fact that each 2000 MWt ATW burner can destroy up to 650 kg of actinides (plutonium and transuranics) per year, and that 700 MWe would be available for distribution to the grid from each burner.

The scenario works as follows: Roughly every two years two new ATW systems are brought on line for the first 20 years. At year 25, the three last plants are added. As the burners and accelerators reach the end of their operational life, they are decommissioned, and the fuel is sent to feed other still operational burners. Eventually, the last three systems in operation will receive all the remnant waste and destroy it down to less than 1 ton over a protracted (5 years) inventory burndown.

Two major characteristics distinguish the accelerator-driven subcritical systems from the critical reactors that had been evaluated for actinide destruction, such as the ALMR: (1) ATW does not produce higher actinides from fertile materials such as  $^{238}\text{U}$ . (2) Because ATW is not constrained by a criticality requirement it can burn down the end-of-life (EOL) actinide inventory to very low levels.

Critical reactors are considerably less efficient in the destruction of transuranic elements (about 125 kg/a, for the same 2000 MWt power rating). They tie up a very large amount of actinides in the core (to maintain criticality), and compared to the actinide inventory, only a small amount of actinides can be destroyed. Critical reactors therefore would require a proportionally larger number of installations over multiple generations (about 300 years) to achieve the same degree of transuranic inventory reduction that ATW systems would reach in 65 years.

# ATW Backlog Burndown scenario

Number of ATW units, coming on line, closing down

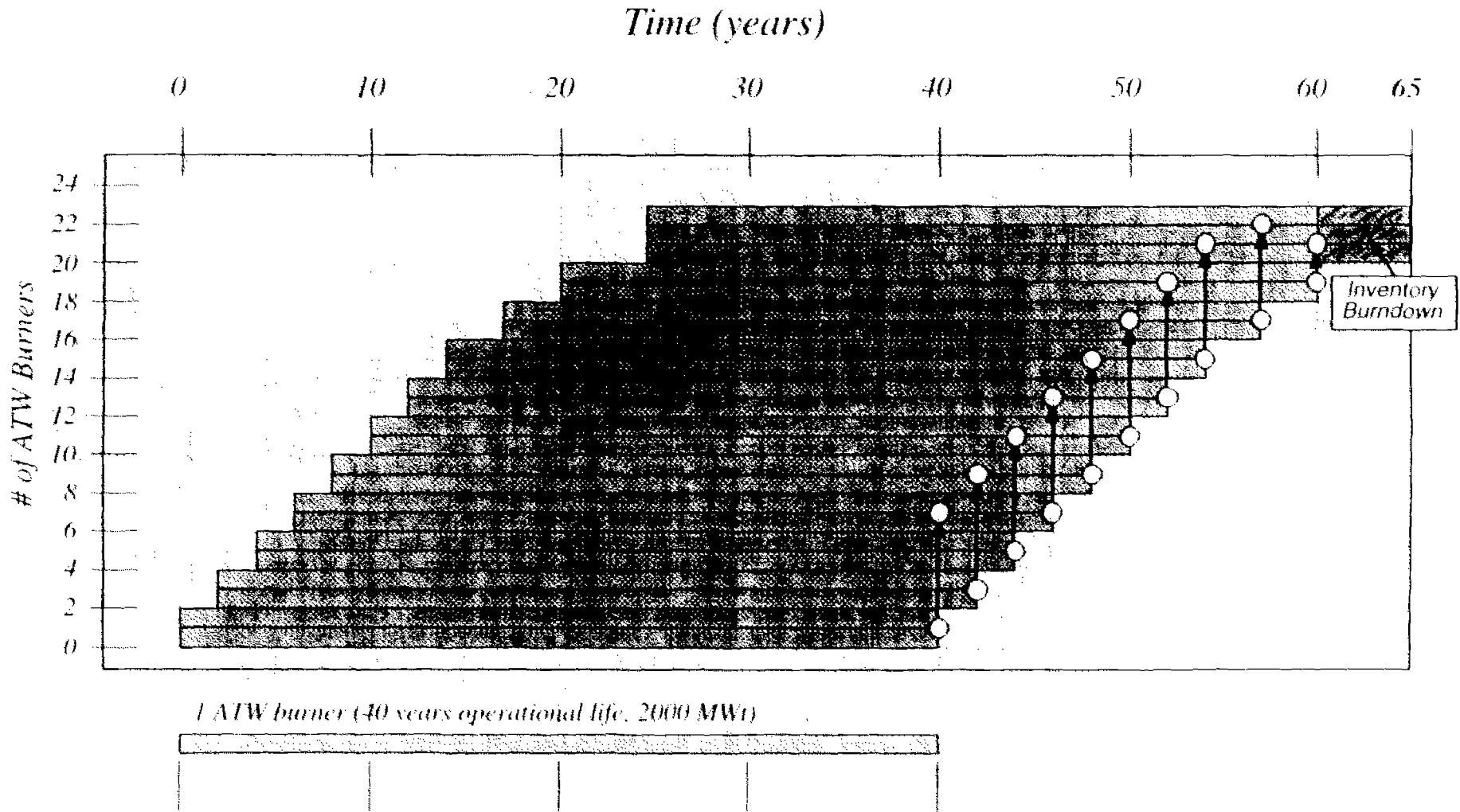
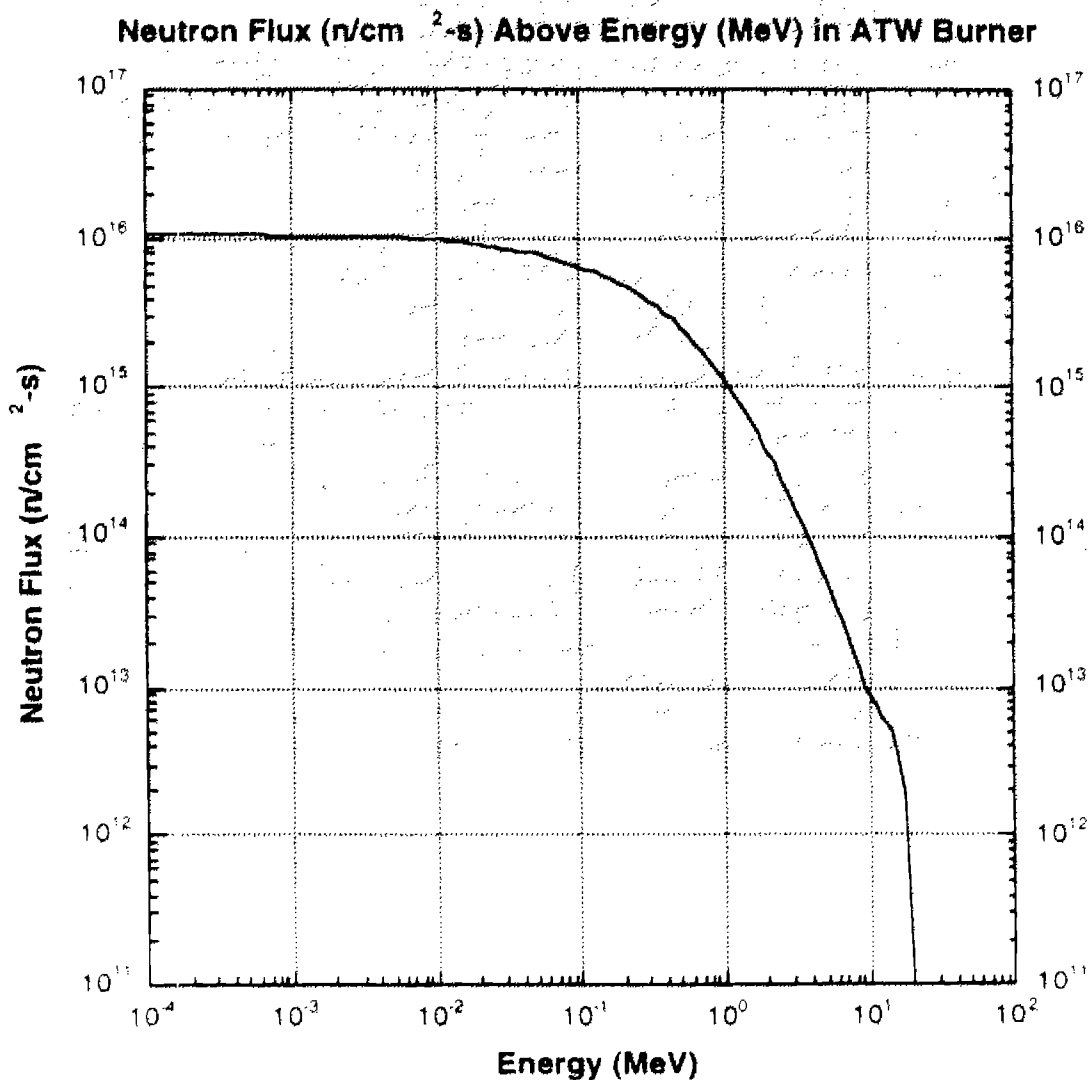

Figure 5

## 2. Neutron spectrum.

The neutron spectrum of the current 2000 MWt Accelerator Transmutation of Waste (ATW) waste burner point design is given in Figure 1. As shown in the Figure, the average total flux seen by the waste during the three burn cycles is  $1.09 \times 10^{16}$  n/cm<sup>2</sup>-s. Sixty percent of this flux has an energy greater than 0.1 MeV. The neutron flux with energy greater than 20 MeV is relatively small. With the proposed fuel shuffling scheme, the total fluence seen by the fuel and clad before it is discharged after three cycles is  $1.7 \times 10^{23}$  n/cm<sup>2</sup> ( $E > 0.1$  MeV).



### **3. Delayed neutron fraction and subcriticality.**

This figure was shown at the presentation, however it was not included in the material that was handed to you at the presentation.

The figure illustrates the delayed neutron fraction for many fissionable isotopes. Delayed neutrons come from the decay of a few fission products, and are the basis for control of critical nuclear systems. The more the better: a reactor will be easier to design and operate safely. If delayed neutrons did not exist, all nuclear systems for power production would have to be externally driven.

The picture shows how close to prompt critical reactors have to get before starting to work as self sustained systems through the action of delayed neutrons. Very literally, it says that thermal reactors (based on  $^{235}\text{U}$  fuel) operate at 0.995 prompt  $K_{\text{eff}}$ , and Fast reactors (based on  $^{239}\text{Pu}$  fuel) operate at 0.998.

The figure also show that the "dollar" measurement of reactivity (which is the amount of reactivity equivalent to the delayed neutron fraction) is not a constant. A dollar for a thermal reactor is about three times as large as a dollar for a fast reactor. A reactor has to stay close to prompt critical within this 1-dollar margin at all times.

Thermal reactors have learned to live and operate quite safely within this margin. Reactors based on plutonium (fast reactors) have a very thin operating margin, and it gets worse going towards the higher actinides. These reactors need a significant buffer of  $^{238}\text{U}$  to dampen reactivity excursions with significant negative prompt feedback to the point that control rods can be effectively used.

The great claim of subcritical system is that they can burn pure transuranic cores, thereby achieving very fast destruction rates. The task is doubly difficult because: 1) there is no  $^{238}\text{U}$  to sweeten the reactivity response of the fuel (typically with negligible or positive Doppler), and 2) the delayed neutron fraction (dollar margin) is significantly smaller for the transuranic actinides than it is for the  $^{235}\text{U}$  based fuels. In a pure waste destruction mode, the equivalent level of control and safety present in LWR reactors can be achieved by operating the system subcritically.

Subcriticality allows any fuel originated (internal) reactivity transient to proceed slowly enough for external feedback to become dominant and reestablish equilibrium. As shown during the review, lead (being a poor neutron absorber and excellent reflector) has a strong negative temperature feedback on reactivity (this is not the case for sodium). The slow nature of the transient allows time for the negative response of the lead coolant to stabilize the excursion.

The chosen subcriticality level should allow for transients in all expected conditions to be self limiting. The specific level is strongly dependent on the burner design.

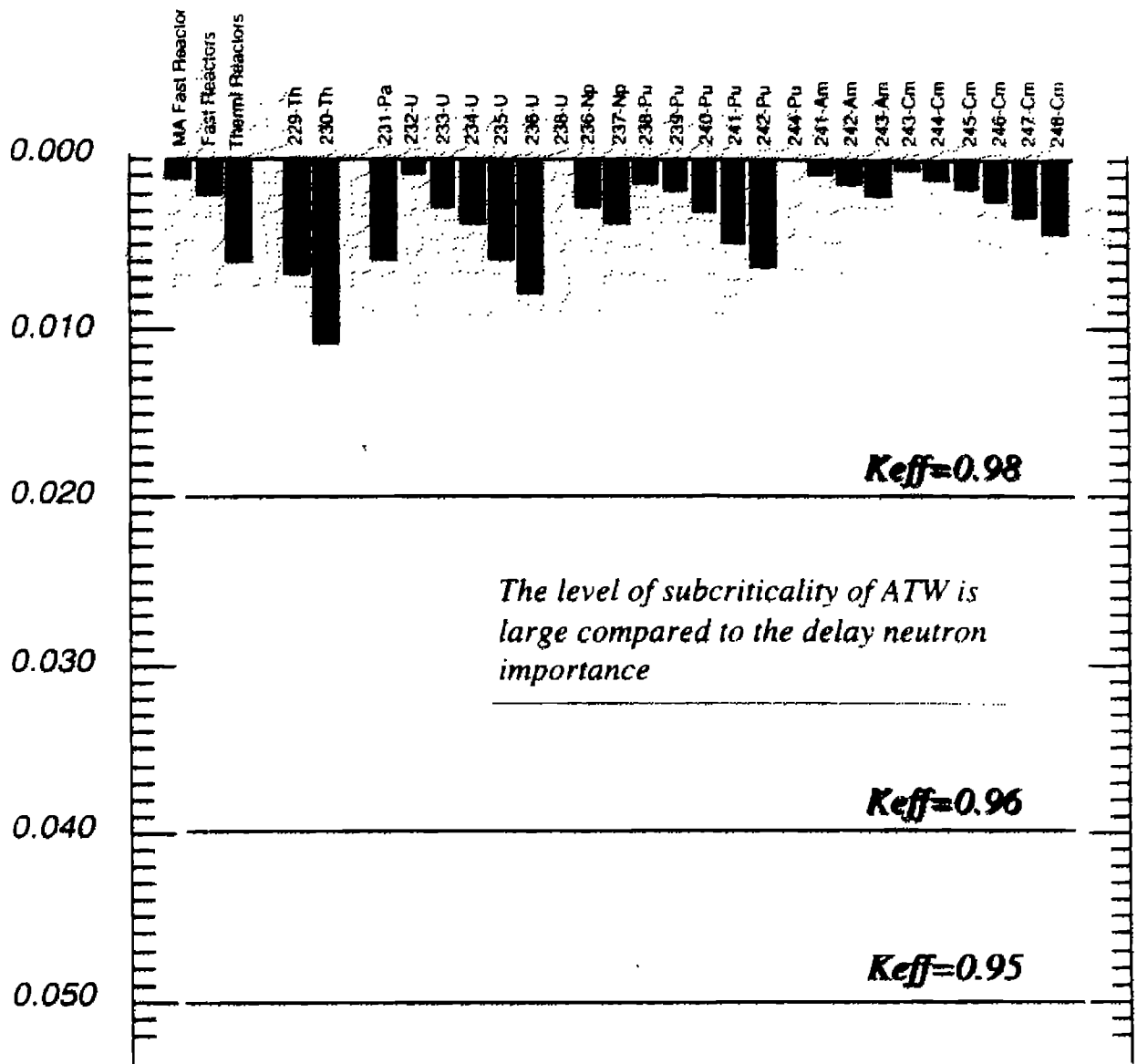

#### **4. Pb-205 production rate and inventory.**

The production rate of Pb-205 (from neutron capture in Pb-204) in the 2000 MWt ATW point design is calculated to be 7 curies per full power year. Because of Pb-205 burnout (and Pb-204 burnout if total coolant volume is relatively low) the total Pb-205 inventory after 40 full power years of operation is expected to be less than 200 curies.

Pb-205 decays via electron capture to the stable isotope Tl-205. There are no alpha, beta, or gamma rays emitted in the decay, only an x-ray. Because the 200 curies of Pb-205 would be mixed with approximately 200 tons of lead-bismuth eutectic, the radiological hazard from the Pb-205 should be relatively small.